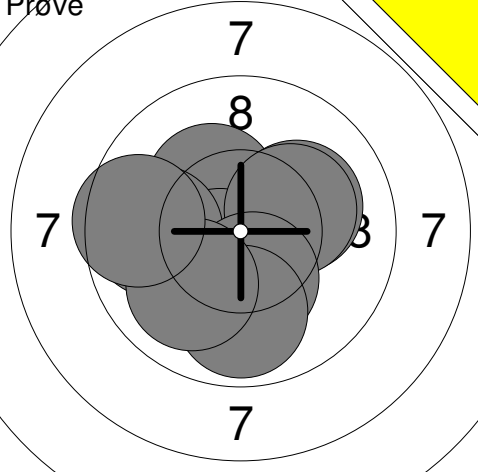
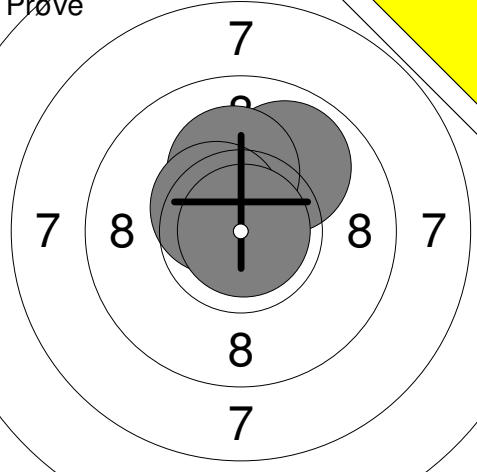
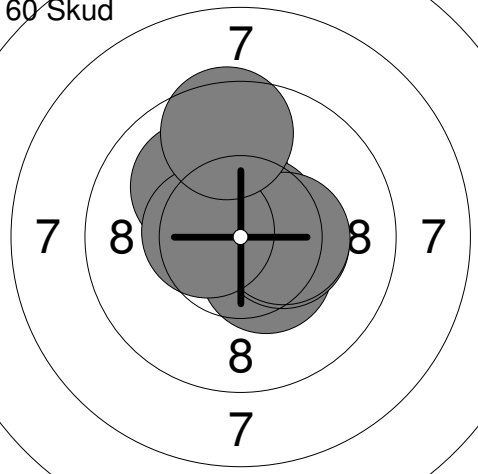
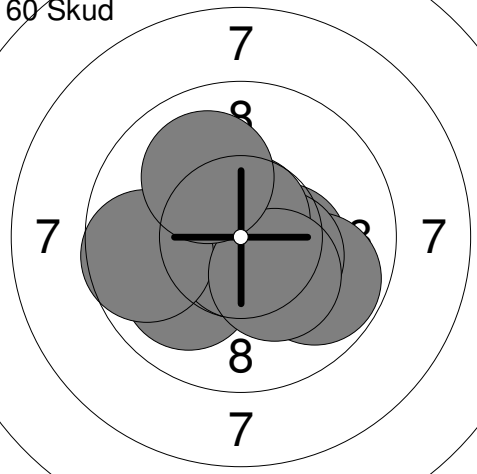
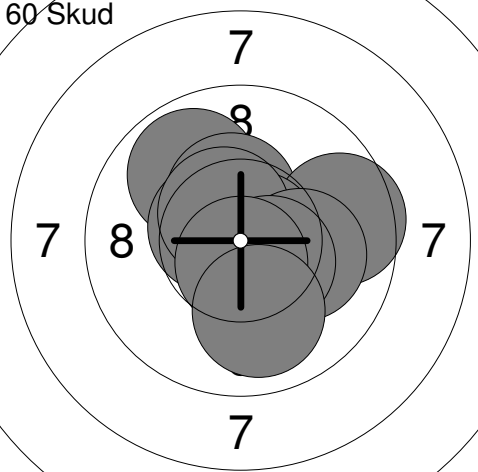
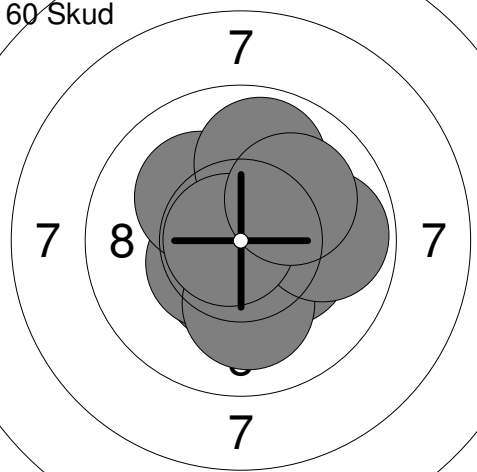
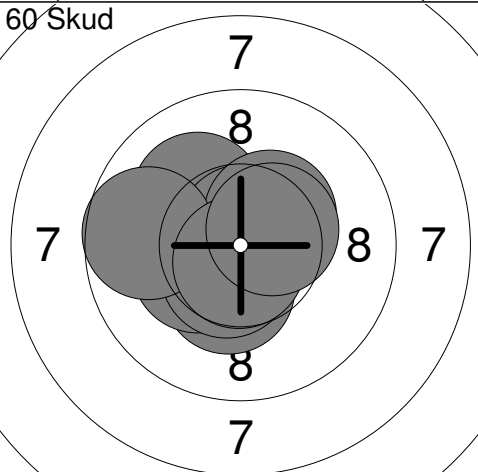
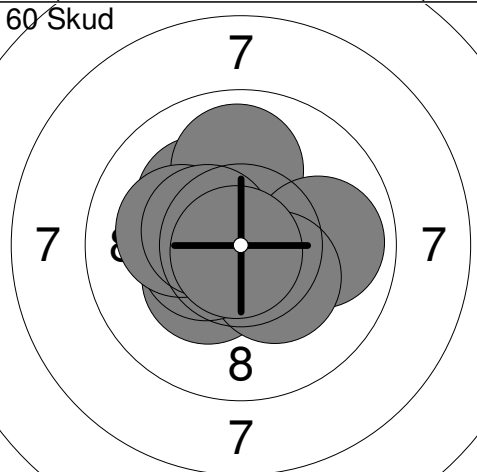
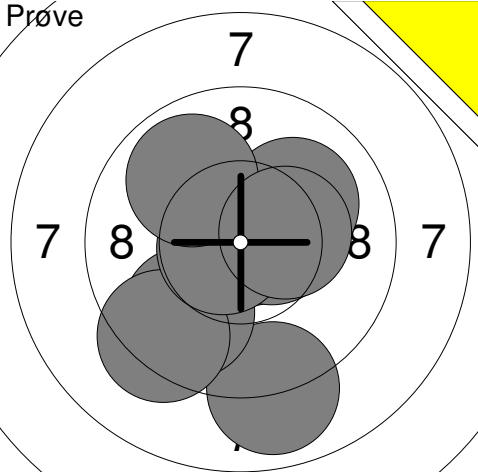
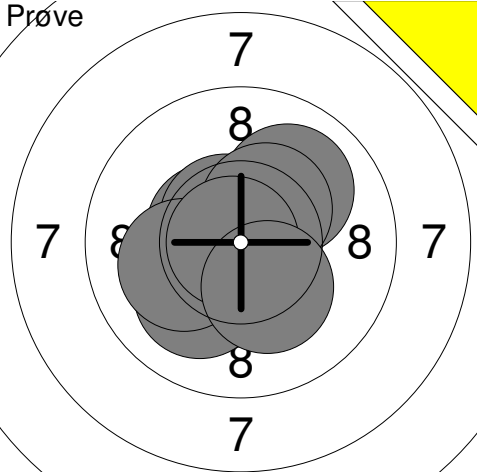
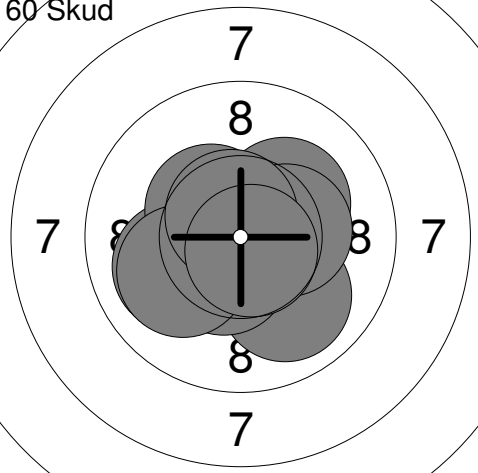
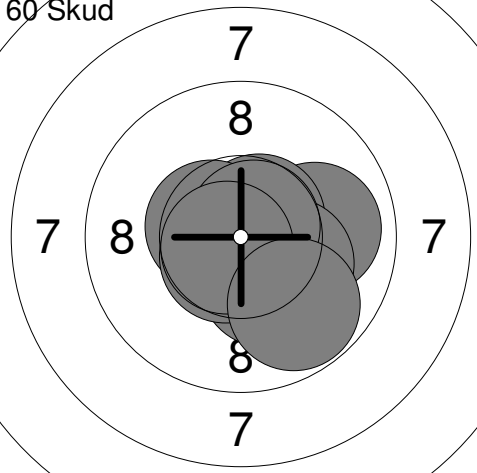
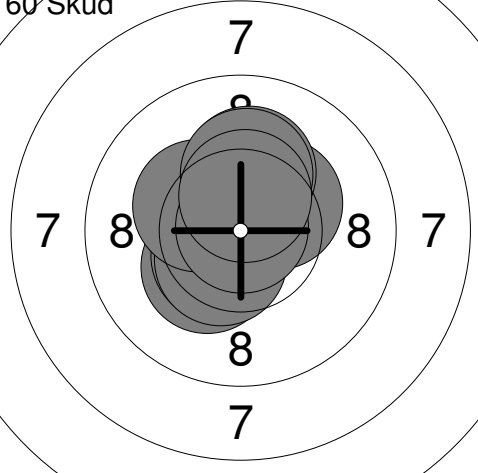
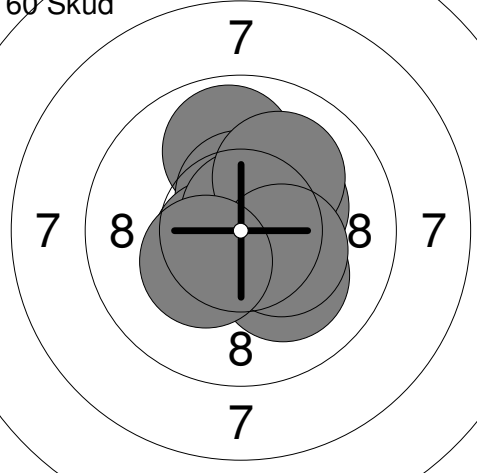
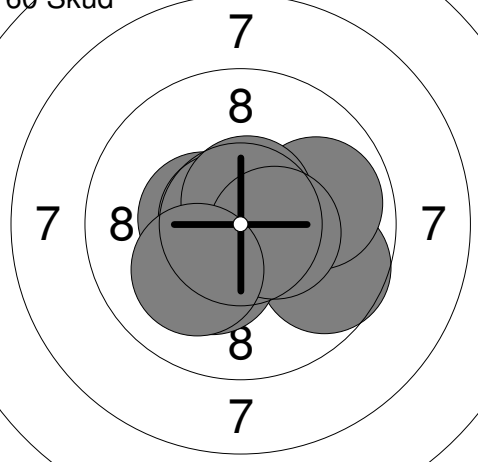
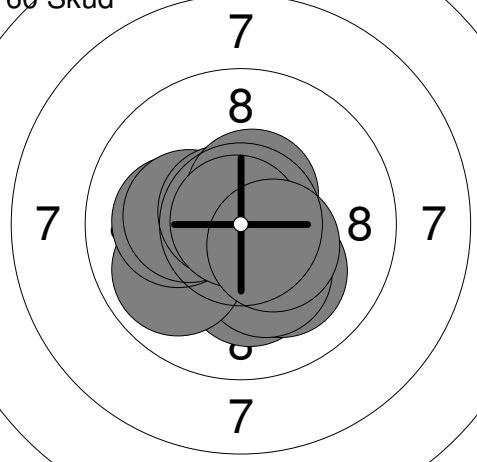
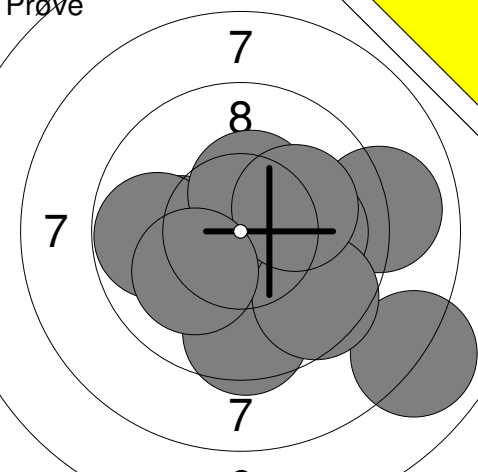
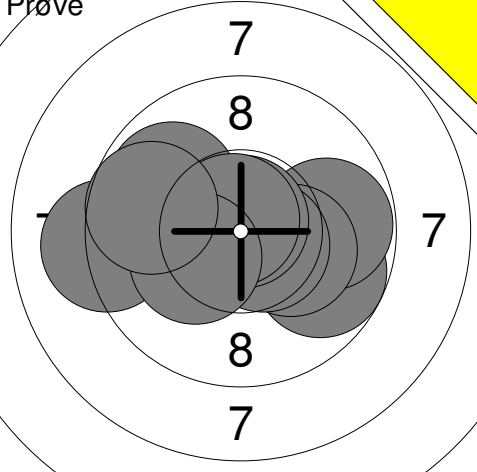
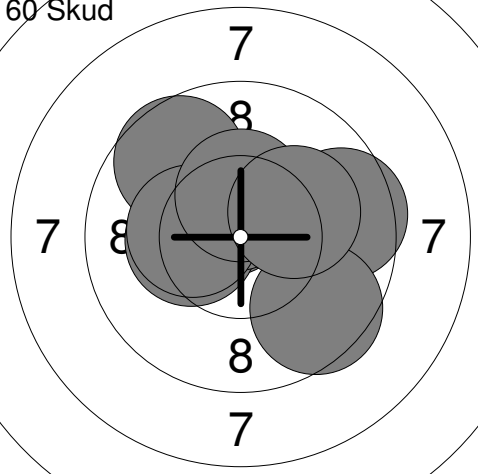
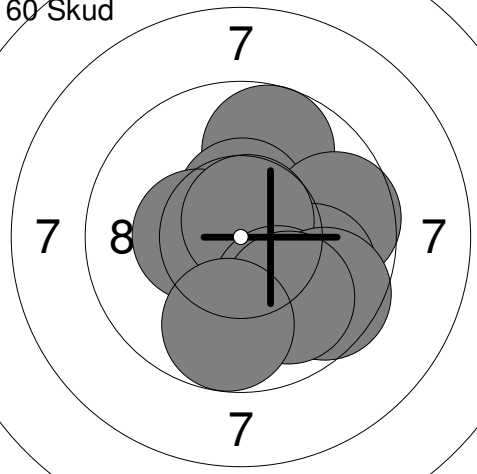
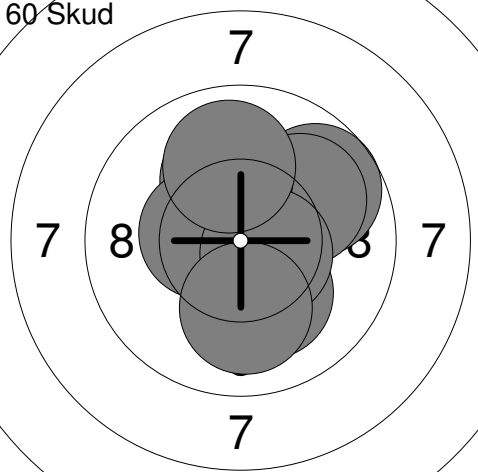
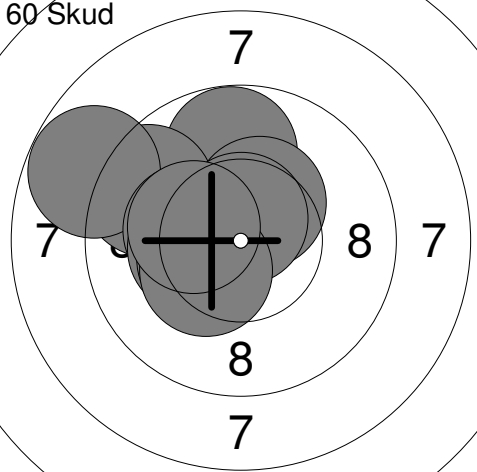
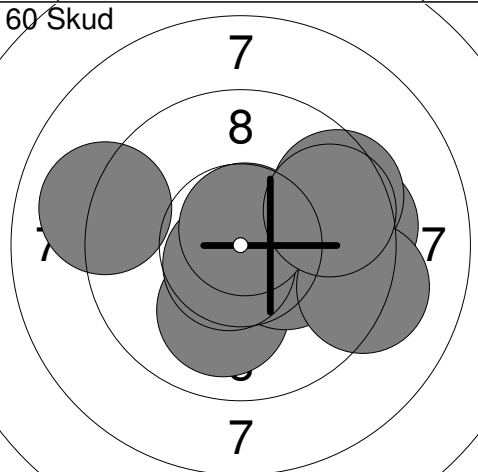
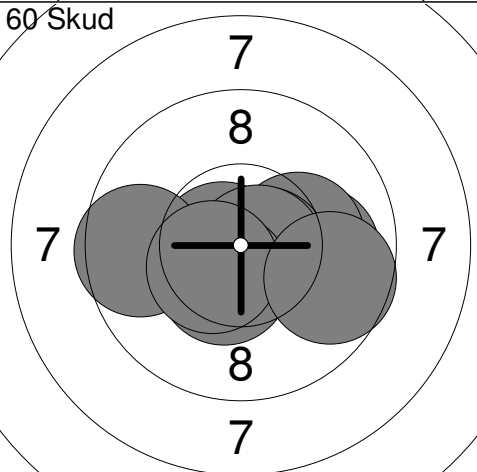

Prøve 	1: 10.5x ↘ 2: 10.3x ↗ 3: 10.1 → 4: 10.5x ↘ 5: 9.8 ← 6: 10.2x → 7: 10.3x ↘ 8: 9.9 ↘ 9: 10.0 ↘ 10: 9.6 ← <hr/> Serie 101.2 Total 0.0	Prøve 	11: 9.9 ↗ 12: 10.1 ↑ 13: 10.5x ↗ 14: 10.9x → <hr/> Serie 41.4 Total 0.0
60 Skud 	1: 10.3x ↗ 2: 10.1 ↗ 3: 10.6x → 4: 10.7x ↗ 5: 10.6x ↗ 6: 10.4x ↘ 7: 10.4x → 8: 10.4x → 9: 10.5x ← 10: 9.5 ↑ <hr/> Serie 103.5 Total 103.5	60 Skud 	11: 10.4x → 12: 10.1 ↘ 13: 10.0 ↘ 14: 9.8 ↘ 15: 10.7x ↘ 16: 10.4x → 17: 10.7x ↑ 18: 9.7 ← 19: 10.3x ↘ 20: 10.0 ↗ <hr/> Serie 102.1 Total 205.6
60 Skud 	21: 9.9 ↗ 22: 10.4x ↑ 23: 10.5x ↗ 24: 9.6 → 25: 10.8x → 26: 10.5x ↗ 27: 10.1 → 28: 10.5x ↘ 29: 10.6x ↘ 30: 10.0 ↘ <hr/> Serie 102.9 Total 308.5	60 Skud 	31: 10.4x ↘ 32: 10.5x ↘ 33: 10.3x → 34: 10.2x ↗ 35: 10.1 ↘ 36: 10.2x → 37: 9.9 ↑ 38: 9.8 → 39: 10.8x ← 40: 10.1 ↗ <hr/> Serie 102.3 Total 410.8
60 Skud 	41: 10.4x ↘ 42: 10.3x ↘ 43: 10.2x ↘ 44: 10.1 ↗ 45: 10.8x ↑ 46: 10.5x ↘ 47: 10.4x ↗ 48: 9.7 ← 49: 10.7x ↘ 50: 10.5x → <hr/> Serie 103.6 Total 514.4	60 Skud 	51: 10.3x ↘ 52: 10.2x ↗ 53: 10.7x ↗ 54: 9.9 ↑ 55: 9.9 → 56: 10.3x ↘ 57: 10.5x ← 58: 10.1 ← 59: 10.5x ← 60: 10.8x ↘ <hr/> Serie 103.2 Total 617.6

Hold	Skive	Rikke Mæng	
AAS	Trehøje		
2016/17		Aalborg Skyttekreds	
Prøve		2: 8.9 ↓ 3: 9.8 ↓ 4: 9.3 ↓ 5: 10.9x → 6: 10.5x → 7: 10.7x ← 8: 10.1 → 9: 9.9 ↑ 10: 10.3x → Serie 90.4 Total 0.0	Prøve  11: 10.5x ← 12: 10.0 → 13: 10.1 ↓ 14: 10.8x → 15: 10.6x → 16: 10.8x ↓ 17: 10.1 ← 18: 10.4x → 19: 10.8x ← 20: 10.2x ↓ Serie 104.3 Total 0.0
60 Skud		1: 10.2x → 2: 10.0 ↓ 3: 10.3x → 4: 10.7x → 5: 10.5x ↓ 6: 10.0 ← 7: 10.4x → 8: 10.0 ← 9: 10.6x → 10: 10.7x ↓ Serie 103.4 Total 103.4	60 Skud  11: 10.4x ↓ 12: 10.3x ↓ 13: 9.9 → 14: 10.6x → 15: 10.5x ← 16: 10.6x ↓ 17: 10.2x → 18: 10.7x → 19: 10.7x ← 20: 9.8 ↓ Serie 103.7 Total 207.1
60 Skud		21: 10.3x ↓ 22: 10.7x ↑ 23: 10.5x ↓ 24: 10.5x ↓ 25: 10.3x → 26: 10.3x → 27: 10.9x ↑ 28: 10.2x ↑ 29: 10.2x ↑ 30: 10.5x ↑ Serie 104.4 Total 311.5	60 Skud  31: 9.9 ↑ 32: 10.3x → 33: 10.5x ↑ 34: 10.6x → 35: 10.1 ↓ 36: 10.6x ← 37: 10.7x ↑ 38: 10.1 ↑ 39: 10.3x → 40: 10.3x ← Serie 103.4 Total 414.9
60 Skud		41: 10.7x → 42: 10.5x ← 43: 9.7 → 44: 10.4x ↓ 45: 10.7x ← 46: 10.2x ↓ 47: 9.9 → 48: 10.6x ↑ 49: 10.5x → 50: 10.1 ↓ Serie 103.3 Total 518.2	60 Skud  51: 10.2x ↓ 52: 10.1 ↓ 53: 10.2x ↓ 54: 9.9 ← 55: 10.1 ← 56: 10.2x ← 57: 10.7x → 58: 10.5x ↑ 59: 10.9x → 60: 10.4x ↓ Serie 103.2 Total 621.4

Hold	Skive	Nanna Bissø	
38	3		
AAS		ÅRK	
2016/17		Aalborg Skyttekreds	
Prøve 	2: 10.5x → 3: 9.6 ↖ 5: 9.5 ↑ 6: 10.7x ↗ 7: 10.2x ↗ 8: 9.5 ↖ 9: 10.6x → 10: 10.0 ↖	Prøve 	11: 10.4x ↗ 12: 9.5 ↖ 13: 9.0 → 14: 10.2x ↗ 15: 10.3x ↑ 16: 9.4 ↗ 17: 9.4 → 18: 10.3x → 19: 9.9 ↖
Serie 80.6	Total 0.0	Serie 88.4	Total 0.0
60 Skud 	1: 10.4x → 2: 9.8 ↗ 3: 10.1 ↘ 4: 9.8 → 5: 10.4x ↖ 6: 10.4x ↘ 7: 10.6x ↗ 8: 10.1 ↘ 9: 10.9x → 10: 9.3 ↖	60 Skud 	11: 10.2x ↖ 12: 10.2x ↘ 13: 10.4x ↖ 14: 10.0 ↘ 15: 9.9 ↖ 16: 9.5 ↖ 17: 10.4x ↗ 18: 10.2x ↖ 19: 10.0 ↘ 20: 10.9x ↗
Serie 101.8	Total 101.8	Serie 101.7	Total 203.5
60 Skud 	21: 10.2x ↗ 22: 10.7x ↗ 23: 10.2x ↖ 24: 10.1 ↑ 25: 10.2x ↖ 26: 10.0 ↖ 27: 10.5x ↗ 28: 10.4x ↖ 29: 10.2x ↗ 30: 10.0 ↘	60 Skud 	31: 10.3x ↗ 32: 10.6x ↗ 33: 10.4x ↘ 34: 10.2x ↖ 35: 9.8 ↘ 36: 10.8x ↘ 37: 9.9 ↘ 38: 9.3 → 39: 10.3x ↗ 40: 10.4x ↘
Serie 102.5	Total 306.0	Serie 102.0	Total 408.0
60 Skud 	41: 10.1 → 42: 10.2x → 43: 10.5x ↘ 44: 10.1 ↖ 45: 10.5x ↗ 46: 10.5x ↘ 47: 10.0 ↘ 48: 10.6x ↖ 49: 10.3x ↘ 50: 10.6x ↗	60 Skud 	51: 9.8 ↘ 52: 10.9x → 53: 10.5x ↘ 54: 10.2x → 55: 10.6x ↘ 56: 9.9 ↗ 57: 10.0 ↘ 58: 9.7 → 59: 9.1 ↖ 60: 10.0 ↘
Serie 103.4	Total 511.4	Serie 100.7	Total 612.1

Hold	Skive	Alexander Helleskov	
38	4		
AAS		Trehøje	
2016/17		Aalborg Skyttekreds	
Prøve 	1: 10.6x ← 2: 10.2x ← 3: 10.0 ↓ 4: 10.4x ← 5: 9.7 ← 6: 10.4x ↓ 7: 10.1 ↑ 8: 10.1 ↗ 9: 10.7x ↗ 10: 10.4x ↗ Serie 102.6 Total 0.0	Prøve 	11: 9.9 ↗ 12: 9.9 ← 13: 10.5x → 14: 10.3x → 15: 9.8 ↗ 16: 10.1 ← 17: 10.4x → 18: 9.9 ↓ 19: 10.0 → 20: 9.9 ↗ Serie 100.7 Total 0.0
60 Skud 	1: 10.7x → 2: 10.2x → 3: 10.5x ↗ 4: 10.5x → 5: 9.8 ← 6: 9.7 ← 7: 10.3x ↗ 8: 10.0 ← 9: 10.3x ↓ 10: 10.8x ← Serie 102.8 Total 102.8	60 Skud 	11: 10.6x ↗ 12: 9.8 ← 13: 10.3x ↗ 14: 10.0 ↗ 15: 10.3x → 16: 10.7x ↓ 17: 10.5x ↓ 18: 10.1 ↓ 19: 10.6x → 20: 10.8x ↗ Serie 103.7 Total 206.5
60 Skud 	21: 10.5x ↓ 22: 10.1 ↗ 23: 10.6x ↗ 24: 10.6x ← 25: 10.5x ↗ 26: 10.6x ↗ 27: 10.4x ↓ 28: 10.3x ↗ 29: 10.1 ↗ 30: 10.6x ↗ Serie 104.3 Total 310.8	60 Skud 	31: 10.4x → 32: 9.4 ↗ 33: 10.5x ↓ 34: 10.0 ← 35: 10.4x ↓ 36: 10.4x ↗ 37: 10.2x ↓ 38: 10.8x ↗ 39: 10.7x ↗ 40: 10.1 ← Serie 102.9 Total 413.7
60 Skud 	41: 10.6x ↗ 42: 10.3x ↗ 43: 10.2x ↗ 44: 10.5x ← 45: 10.3x ← 46: 10.4x ↗ 47: 10.3x → 48: 10.7x ↗ 49: 10.3x ↓ 50: 10.7x ↗ Serie 104.3 Total 518.0	60 Skud 	51: 9.9 → 52: 10.4x ↗ 53: 10.2x ↗ 54: 10.5x ↓ 55: 10.5x ↗ 56: 10.2x → 57: 10.6x ↗ 58: 10.0 ← 59: 10.6x ↓ 60: 10.3x ↓ Serie 103.2 Total 621.2

Prøve 	1: 8.0 → 2: 9.5 ↓ 3: 9.0 → 4: 10.1 ← 5: 9.8 ← 6: 10.0 → 7: 10.4x ↑ 8: 9.6 ↓ 9: 10.1 → 10: 10.1 ↙ <hr/> Serie 96.6 Total 0.0	Prøve 	11: 9.8 → 12: 9.8 → 13: 10.2x → 14: 9.1 ← 15: 10.6x → 16: 9.9 ↗ 17: 10.8x ↑ 18: 10.8x ↗ 19: 10.2x ← 20: 9.7 ← <hr/> Serie 100.9 Total 0.0
60 Skud 	1: 10.5x ↑ 2: 10.3x ← 3: 9.6 → 4: 10.3x ↗ 5: 9.5 ↓ 6: 10.5x ↑ 7: 9.6 ↗ 8: 10.3x ← 9: 10.4x ↑ 10: 10.2x → <hr/> Serie 101.2 Total 101.2	60 Skud 	11: 9.7 ↑ 12: 10.5x ↑ 13: 9.7 → 14: 10.4x ← 15: 9.9 → 16: 10.7x ↗ 17: 10.1 ↓ 18: 9.6 ↓ 19: 9.9 ↓ 20: 9.7 ↓ <hr/> Serie 100.2 Total 201.4
60 Skud 	21: 10.5x ↗ 22: 9.7 → 23: 10.4x ↑ 24: 10.0 → 25: 10.1 ↑ 26: 10.5x ← 27: 10.2x ↓ 28: 10.6x → 29: 10.0 ↓ 30: 9.9 ↑ <hr/> Serie 101.9 Total 303.3	60 Skud 	31: 9.8 ↑ 32: 9.5 ↗ 33: 8.8 ↗ 34: 10.2x ← 35: 10.4x ↗ 36: 10.3x ← 37: 10.4x ← 38: 10.7x ↑ 39: 10.3x ← 40: 10.3x ← <hr/> Serie 100.7 Total 404.0
60 Skud 	41: 10.0 ↓ 42: 9.4 → 43: 10.7x → 44: 10.3x → 45: 9.5 → 46: 10.6x ↓ 47: 9.2 → 48: 9.1 ← 49: 10.7x ↑ 50: 9.7 → <hr/> Serie 99.2 Total 503.2	60 Skud 	51: 10.7x ↓ 52: 10.0 → 53: 10.7x ← 54: 10.2x → 55: 10.6x → 56: 10.7x → 57: 10.5x ↓ 58: 9.6 ← 59: 10.5x ← 60: 9.7 → <hr/> Serie 103.2 Total 606.4

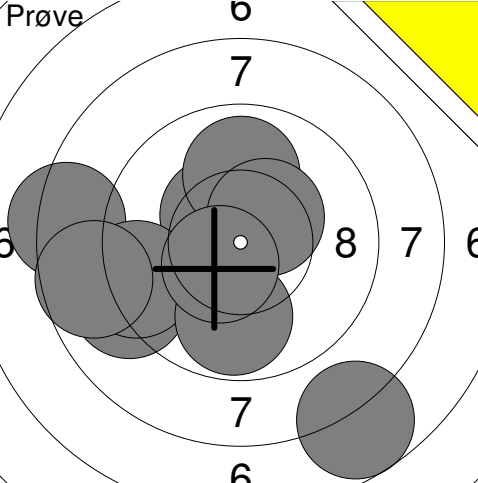
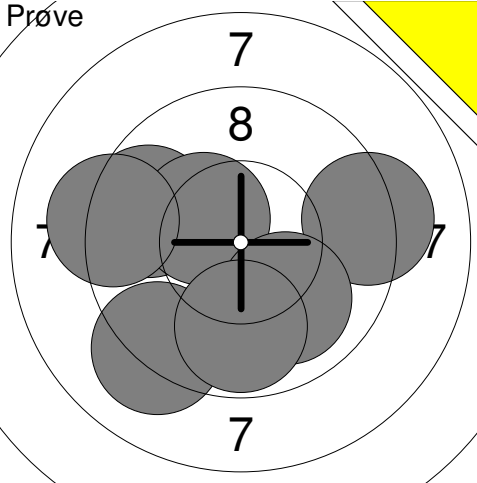
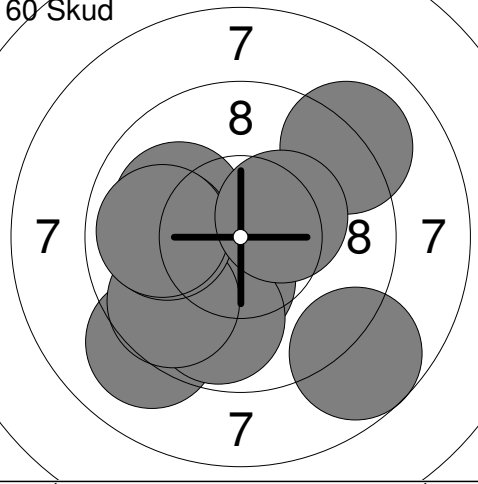
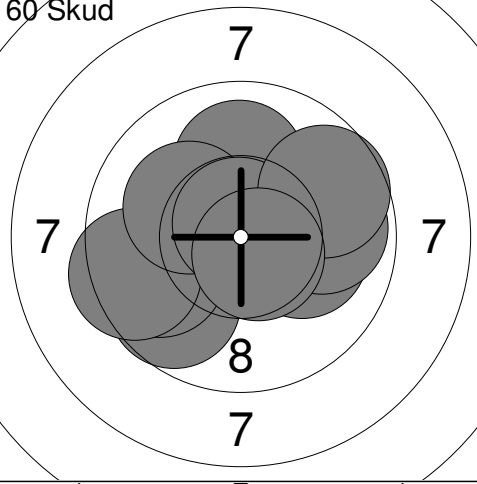
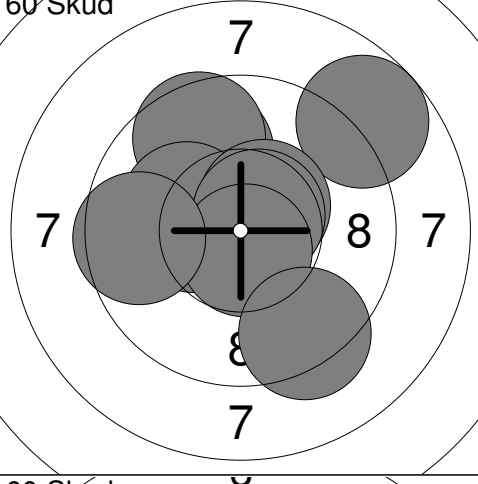
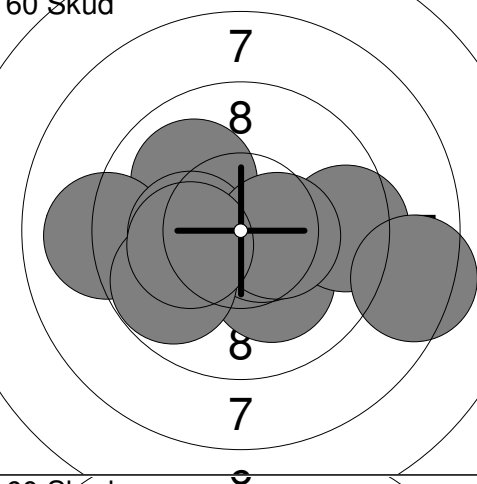
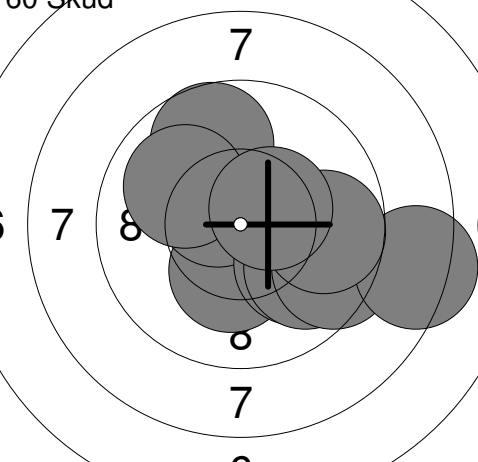
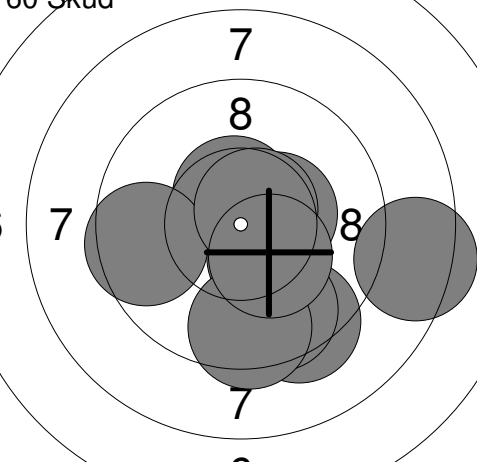
Hold 38	Skive 6	Martin Mohr	
AAS		Trehøje	
2016/17		Aalborg Skyttekreds	
Prøve 	1: 8.3 ← 2: 10.4x ↗ 3: 7.7 ↘ 4: 9.9 ↑ 5: 9.0 ← 6: 9.3 ← 7: 8.7 ← 8: 9.8 ↓ 9: 10.4x ↗ 10: 10.5x ↘ Serie 94.0 Total 0.0	Prøve 	11: 9.2 → 12: 9.6 ← 13: 10.4x ↗ 14: 9.1 ↘ 15: 10.0 ↘ 16: 9.8 ↓ 17: 9.2 ← Serie 67.3 Total 0.0
60 Skud 	1: 10.3x ↓ 2: 10.0 ← 3: 8.7 ↘ 4: 9.1 ↘ 5: 9.8 ↓ 6: 9.7 ↘ 7: 10.0 ← 8: 9.1 ↗ 9: 9.9 ← 10: 10.3x ↗ Serie 96.9 Total 96.9	60 Skud 	11: 9.7 ↘ 12: 10.1 → 13: 10.0 ↑ 14: 9.8 ← 15: 9.4 ← 16: 10.1 ↗ 17: 10.8x ↑ 18: 9.9 → 19: 9.7 ↗ 20: 10.6x ↘ Serie 100.1 Total 197.0
60 Skud 	21: 9.8 ↗ 22: 8.7 ↗ 23: 9.6 ↗ 24: 10.3x ← 25: 10.2x ↗ 26: 10.5x ↗ 27: 10.6x ↗ 28: 10.7x ↓ 29: 9.3 ↓ 30: 9.6 ← Serie 99.3 Total 296.3	60 Skud 	31: 10.1 ↘ 32: 9.5 → 33: 10.6x ↘ 34: 8.4 → 35: 10.0 ↗ 36: 9.1 ← 37: 10.2x ← 38: 9.8 ↘ 39: 10.4x → 40: 10.2x ← Serie 98.3 Total 394.6
60 Skud 	41: 10.3x ↓ 42: 10.5x ↗ 43: 10.0 ↘ 44: 9.7 ↗ 45: 9.8 ↓ 46: 9.5 ↘ 47: 8.3 → 48: 9.7 → 49: 10.0 ↗ 50: 10.5x ↗ Serie 98.3 Total 492.9	60 Skud 	51: 10.3x ↘ 52: 8.4 → 53: 10.6x ↑ 54: 9.6 ← 55: 9.3 ↘ 56: 10.4x → 57: 9.6 ↘ 58: 9.5 ↓ 59: 10.7x ↗ 60: 10.3x ↘ Serie 98.7 Total 591.6

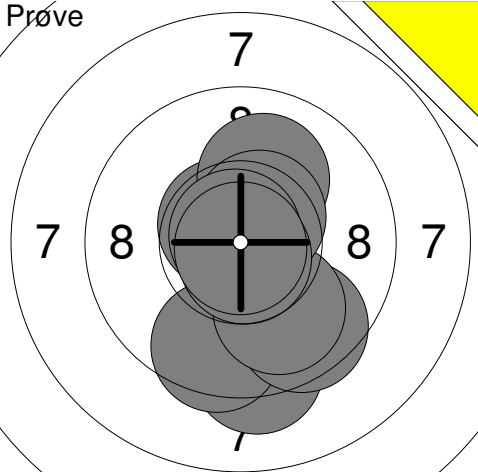
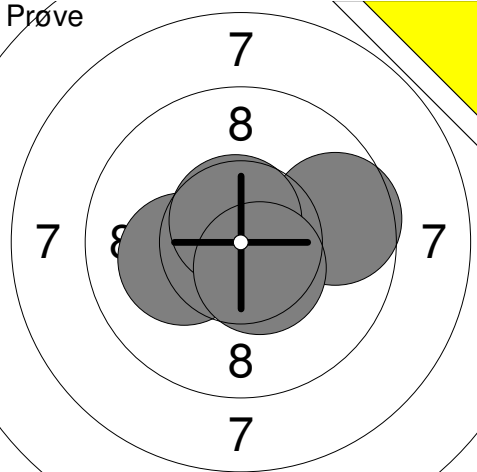
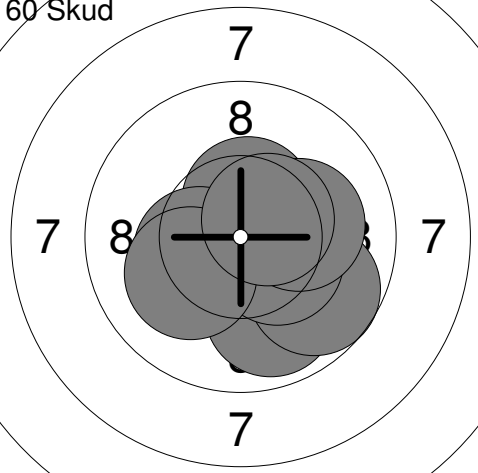
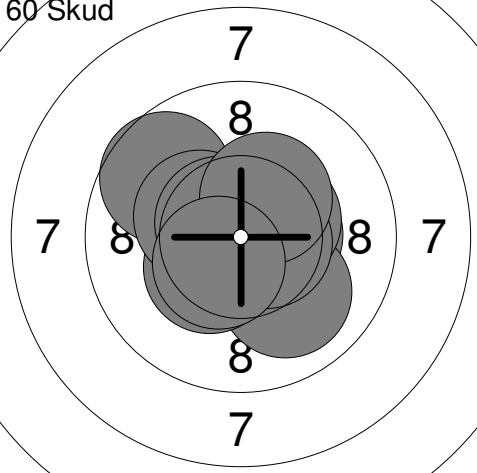
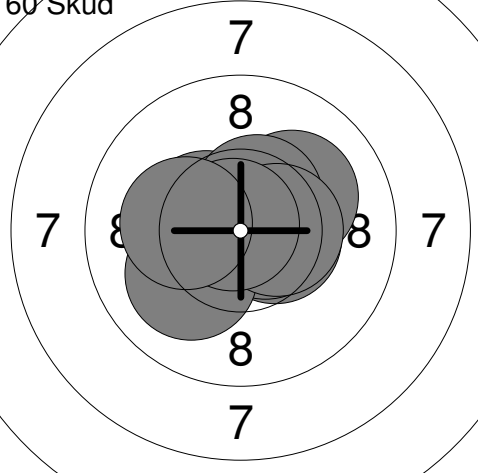
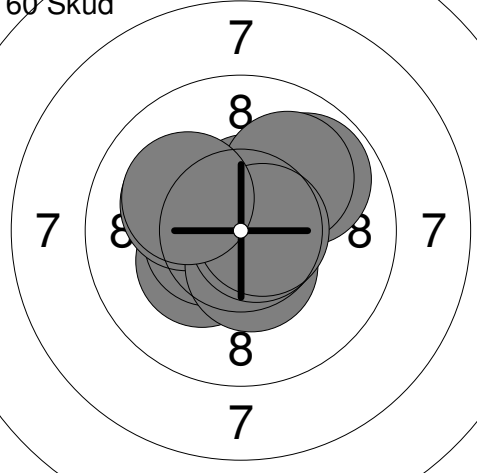
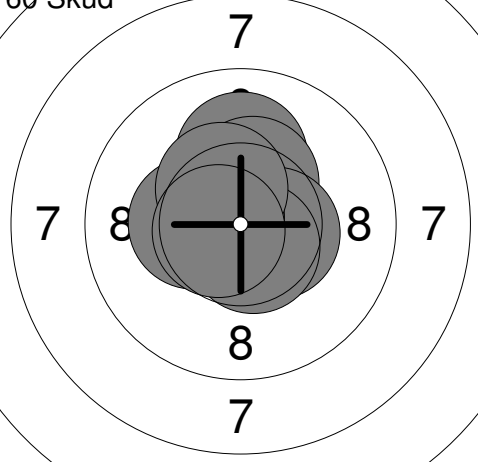
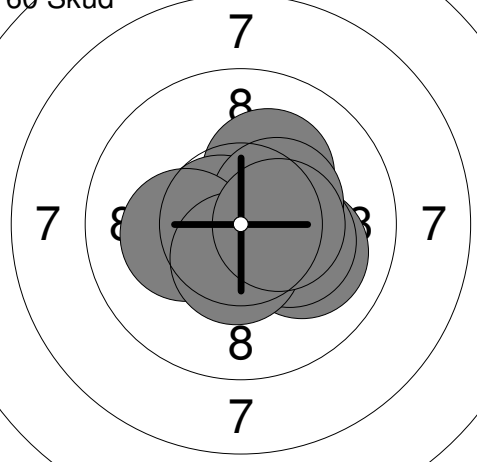
Hold 38	Skive 7	Anna Skade	
AAS		Særslev	
2016/17		Aalborg Skyttekreds	
Prøve 	1: 9.2 ↓ 2: 9.5 ↓ 3: 9.5 ↓ 4: 9.9 ↓ 5: 10.6x ↗ 6: 10.0 ↑ 7: 10.5x ↗ 8: 10.7x ↓ 9: 10.8x ↗ 10: 10.9x ↓ Serie 101.6 Total 0.0	Prøve 	11: 10.2x ← 12: 9.6 → 13: 10.7x ↑ 14: 10.5x ↓ Serie 41.0 Total 0.0
60 Skud 	1: 10.6x ↗ 2: 10.5x ↑ 3: 10.5x ↓ 4: 10.4x ← 5: 9.9 ↓ 6: 9.7 ↓ 7: 10.4x ↓ 8: 10.1 ↓ 9: 10.2x → 10: 10.5x ↗ Serie 102.8 Total 102.8	60 Skud 	11: 10.5x → 12: 10.0 ↓ 13: 10.4x ↓ 14: 9.7 ↗ 15: 10.3x ↗ 16: 10.4x → 17: 10.6x ↗ 18: 10.6x → 19: 10.3x ↗ 20: 10.5x ↓ Serie 103.3 Total 206.1
60 Skud 	21: 10.5x → 22: 10.5x ← 23: 10.6x → 24: 10.1 ↗ 25: 10.8x ↑ 26: 10.1 ↓ 27: 10.5x ↗ 28: 10.5x → 29: 10.8x ↗ 30: 10.2x ← Serie 104.6 Total 310.7	60 Skud 	31: 10.3x ← 32: 9.8 ↗ 33: 10.5x ← 34: 10.1 ← 35: 10.5x ↓ 36: 10.5x ↑ 37: 10.0 ↗ 38: 10.7x → 39: 10.7x → 40: 10.1 ↗ Serie 103.2 Total 413.9
60 Skud 	41: 10.7x ↓ 42: 10.1 ↑ 43: 10.4x ↑ 44: 10.7x ↗ 45: 10.5x → 46: 10.6x ↓ 47: 10.6x ← 48: 10.3x ← 49: 10.4x ↗ 50: 10.6x ← Serie 104.9 Total 518.8	60 Skud 	51: 10.2x ↗ 52: 10.0 → 53: 10.7x ← 54: 10.7x ↓ 55: 10.6x ↓ 56: 10.2x → 57: 10.4x ↗ 58: 10.2x ← 59: 10.5x ↓ 60: 10.4x → Serie 103.9 Total 622.7

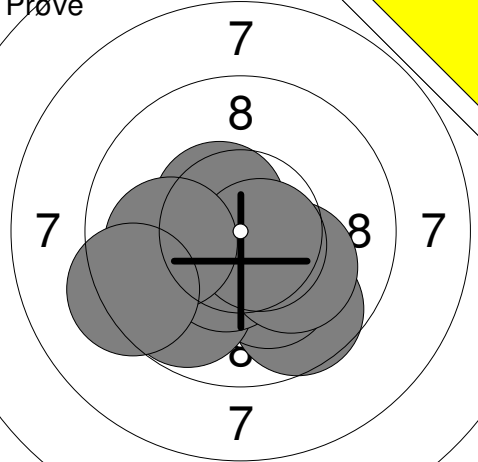
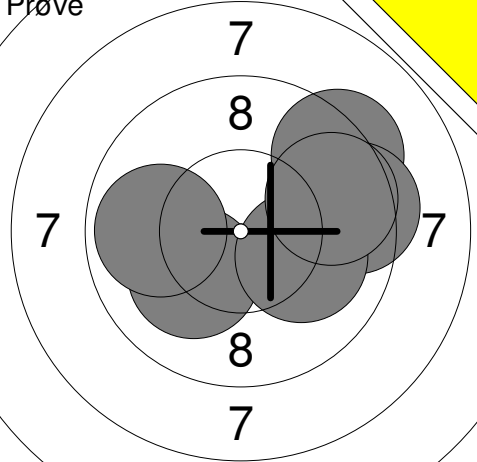
Prøve 	1: 9.6 ↘ 2: 10.2x ↘ 3: 9.8 ↘ 4: 10.6x ↘ 5: 10.4x ↘ 6: 10.1 ↘ 7: 10.5x ↗ 8: 10.6x ↘ 9: 10.0 ← 10: 9.3 ↘ Serie 101.1 Total 0.0	Prøve 	11: 10.1 ↘ 12: 9.3 ↗ 13: 9.4 → 14: 10.1 → 15: 9.9 ← 16: 9.7 → Serie 58.5 Total 0.0
--	---	--	---

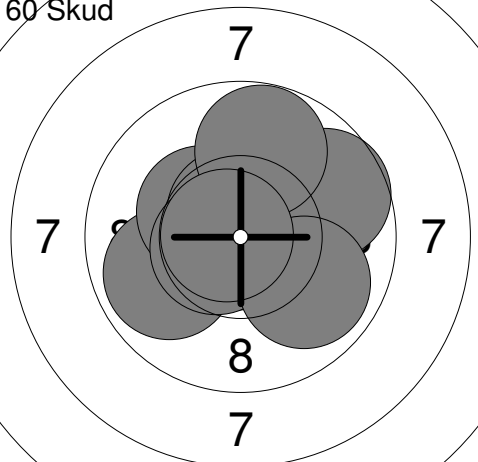
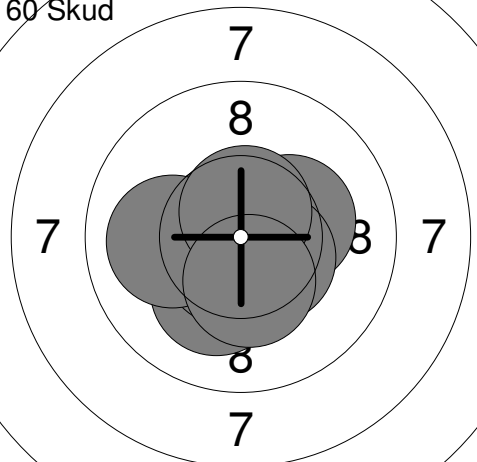
60 Skud 	1: 9.9 ← 2: 10.3x ↗ 3: 10.6x ↗ 4: 10.5x ↗ 5: 10.8x ↘ 6: 10.6x ← 7: 9.7 ↗ 8: 9.8 ↑ 9: 9.9 ↘ 10: 10.8x ← Serie 102.9 Total 102.9	60 Skud 	11: 10.7x ↖ 12: 10.3x → 13: 10.6x ↘ 14: 10.2x ↘ 15: 10.6x ↘ 16: 10.9x ↗ 17: 10.5x ↘ 18: 10.0 ← 19: 10.6x ↑ 20: 10.3x ↘ Serie 104.7 Total 207.6
---	---	---	---

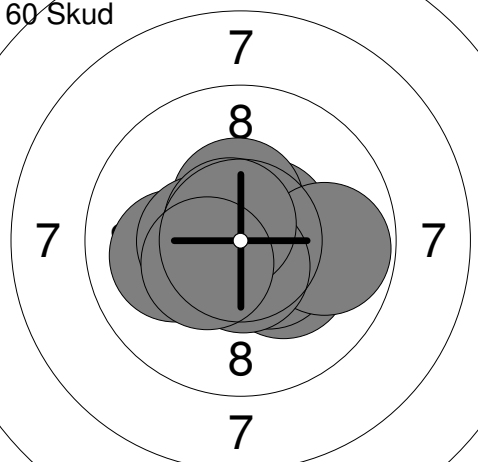
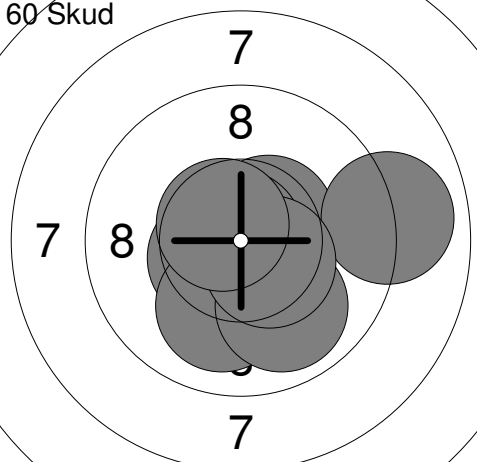
60 Skud 	21: 10.0 ← 22: 10.6x ↗ 23: 10.5x ↑ 24: 10.2x ↘ 25: 10.5x ↘ 26: 9.8 → 27: 10.6x ↘ 28: 10.4x ← 29: 10.7x ↗ 30: 10.4x ↘ Serie 103.7 Total 311.3	60 Skud 	31: 10.3x ↘ 32: 10.5x ↗ 33: 8.9 → 34: 10.5x ↘ 35: 10.9x ↗ 36: 10.5x ← 37: 10.0 ↘ 38: 9.9 ↘ 39: 10.5x ↘ 40: 10.6x ↗ Serie 102.6 Total 413.9
--	---	--	---

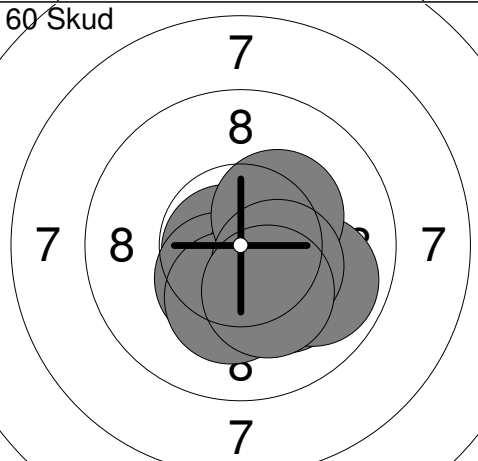
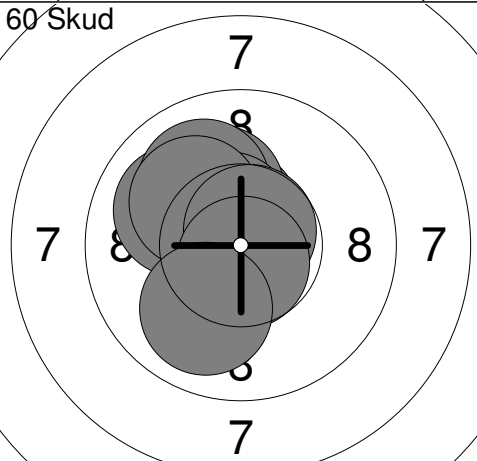
60 Skud 	41: 10.1 ↘ 42: 10.8x ← 43: 9.9 ↘ 44: 10.4x ↘ 45: 10.3x ↘ 46: 10.5x ↘ 47: 10.2x ↘ 48: 10.3x ↗ 49: 10.4x ↘ 50: 10.2x ↘ Serie 103.1 Total 517.0	60 Skud 	51: 10.5x ↑ 52: 10.0 ↖ 53: 10.2x ↗ 54: 10.0 ↗ 55: 10.5x ↗ 56: 10.8x ↑ 57: 10.1 ↗ 58: 10.7x ↗ 59: 10.7x ↘ 60: 10.0 ↘ Serie 103.5 Total 620.5
--	---	--	--

Hold	Skive	Christinna Herskind	
38	10		
AAS		Aalborg Skyttekreds	
2016/17		Aalborg Skyttekreds	
Prøve 	1: 9.9 ↓ 2: 10.8x ↓ 3: 9.9 ↓ 4: 10.7x ↑ 5: 9.7 ↗ 6: 9.7 ↗ 7: 10.2x ↗ 8: 10.6x ← 9: 10.0 ↓ 10: 10.2x ↓ Serie 101.7 Total 0.0	Prøve 	11: 10.2x ↙ 12: 10.7x ↑ 13: 10.6x → 14: 10.5x ↙ 15: 10.6x ↗ 16: 10.6x → 17: 10.2x ← 18: 10.6x ↑ 19: 10.1 ↗ Serie 94.1 Total 0.0
60 Skud 	1: 10.0 ↑ 2: 9.8 → 3: 10.4x ← 4: 9.9 → 5: 9.5 ↗ 6: 10.2x ↓ 7: 10.2x ↗ 8: 10.0 ↗ 9: 10.7x ↗ 10: 10.3x ↓ Serie 101.0 Total 101.0	60 Skud 	11: 10.2x ← 12: 10.2x ↑ 13: 10.5x ↗ 14: 10.1 ↓ 15: 10.4x → 16: 9.8 ↓ 17: 10.8x ↗ 18: 10.3x ↓ 19: 10.7x → 20: 9.6 → Serie 102.6 Total 203.6
60 Skud 	21: 10.4x → 22: 10.7x ↗ 23: 10.5x ↗ 24: 9.6 → 25: 9.5 ↓ 26: 10.2x → 27: 10.1 ↓ 28: 10.1 ↑ 29: 10.4x ↗ 30: 9.7 ↑ Serie 101.2 Total 304.8	60 Skud 	31: 10.8x ← 32: 10.7x ↑ 33: 10.1 ↗ 34: 10.3x ↑ 35: 10.6x ↓ 36: 10.2x ↓ 37: 9.9 ↗ 38: 9.3 → 39: 9.5 ↗ 40: 10.5x ↗ Serie 101.9 Total 406.7
60 Skud 	41: 10.0 ↑ 42: 10.5x ← 43: 10.7x ↑ 44: 10.5x ↗ 45: 10.5x ↑ 46: 10.5x ↗ 47: 10.7x → 48: 10.6x ↗ 49: 10.7x ↗ 50: 10.4x ↗ Serie 105.1 Total 511.8	60 Skud 	51: 10.4x → 52: 10.2x ↗ 53: 10.0 ↑ 54: 10.6x ↗ 55: 10.5x ↗ 56: 10.6x ← 57: 10.4x ↗ 58: 9.5 ↑ 59: 10.3x ↗ 60: 10.3x ← Serie 102.8 Total 614.6

Hold	Skive	Rasmus Hansen			
38	11				
AAS		Særslev			
2016/17		Aalborg Skyttekreds			
Prøve		1: 10.2x ↗ 2: 9.0 ← 3: 8.2 ↘ 4: 10.1 ↗ 5: 10.5x ↘ 6: 10.5x ↘ 7: 10.1 ↘ 8: 10.4x ← 9: 10.4x → 10: 10.5x ↗ Serie 99.9 Total 0.0	Prøve		11: 9.7 ← 12: 10.2x ↗ Serie 19.9 Total 0.0
60 Skud		1: 10.2x → 2: 10.5x ← 3: 10.9x ↘ 4: 10.1 → 5: 10.0 ↘ 6: 10.3x ↘ 7: 10.0 ↘ 8: 9.0 → 9: 9.9 ↘ 10: 10.4x ↘ Serie 101.3 Total 101.3	60 Skud		11: 9.4 ↘ 12: 10.0 ↘ 13: 9.9 ↗ 14: 10.2x ← 15: 10.3x ← 16: 9.2 ← 17: 10.2x ↗ 18: 10.0 ← 19: 10.6x ↗ 20: 10.5x ↗ Serie 100.3 Total 201.6
60 Skud		21: 10.8x ↗ 22: 10.2x ↗ 23: 10.6x ↘ 24: 10.4x → 25: 9.6 → 26: 9.3 ← 27: 9.8 ← 28: 9.4 ↗ 29: 10.7x ↗ 30: 10.3x ↘ Serie 101.1 Total 302.7	60 Skud		31: 10.2x ← 32: 9.3 → 33: 10.3x ↘ 34: 9.7 ↘ 35: 9.3 ← 36: 9.3 ↗ 37: 9.5 ↘ 38: 10.5x ← 39: 10.3x → 40: 10.9x ↗ Serie 99.3 Total 402.0
60 Skud		41: 10.5x → 42: 10.6x ↗ 43: 9.8 ← 44: 10.1 ↘ 45: 8.5 ↗ 46: 10.0 ↗ 47: 8.7 → 48: 9.4 ↘ 49: 9.6 ↘ 50: 10.8x ↗ Serie 98.0 Total 500.0	60 Skud		51: 10.3x ← 52: 8.7 ← 53: 9.7 ↘ 54: 9.2 ↗ 55: 9.6 → 56: 10.2x ↗ 57: 10.6x ↗ 58: 7.7 ↗ 59: 9.8 ↘ 60: 9.7 ↘ Serie 95.5 Total 595.5

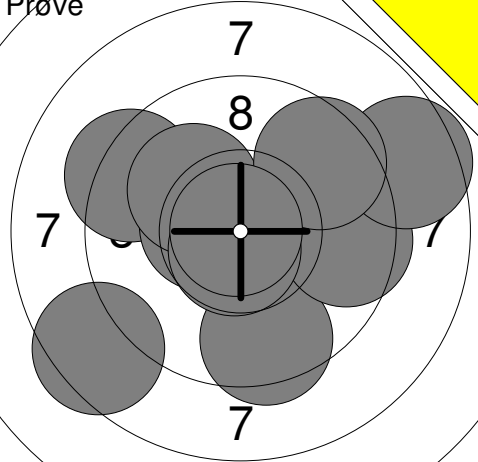
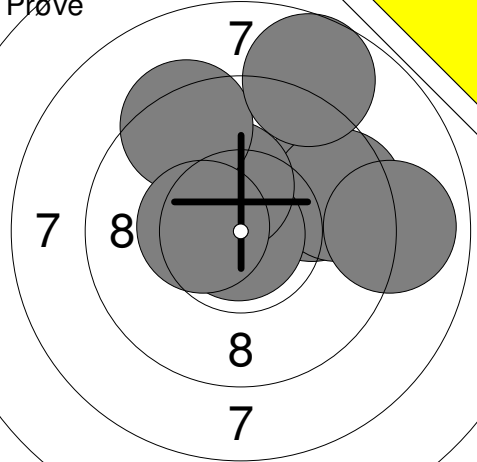
<p>Prøve</p> 	<p>1: 9.5 ↓ 2: 8.5 ↙ 3: 9.3 ↗ 4: 9.5 → 5: 10.5x ← 6: 10.1 ↗ 7: 10.7x ↓ 8: 8.5 → 9: 9.5 ↗ 10: 10.9x ←</p> <p>Serie 97.0 Total 0.0</p>	<p>Prøve</p> 	<p>11: 9.9 → 12: 10.6x ↗ 13: 9.6 → 14: 10.9x ↙ 15: 10.3x ↗ 16: 9.4 ↗ 17: 8.9 → 18: 8.7 ↗ 19: 10.4x ←</p> <p>Serie 88.7 Total 0.0</p>
---	--	---	--

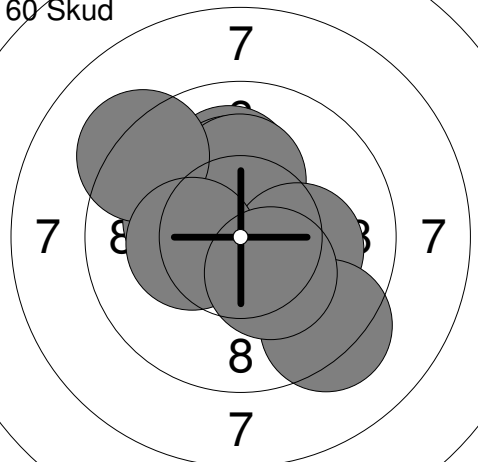
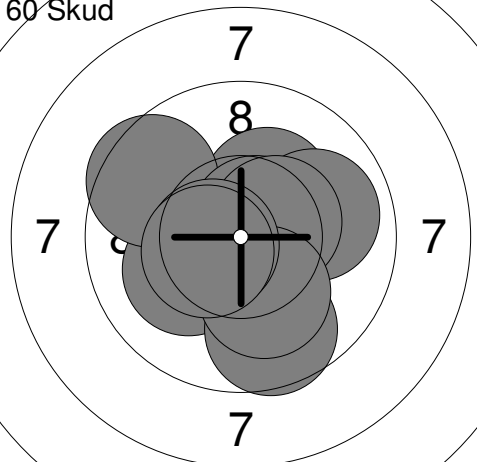
<p>60 Skud</p> 	<p>1: 10.2x ← 2: 10.1 ↗ 3: 10.2x ↗ 4: 10.9x ← 5: 10.2x ↗ 6: 9.2 ↗ 7: 10.2x → 8: 9.3 ↓ 9: 10.3x ← 10: 10.3x ↓</p> <p>Serie 100.9 Total 100.9</p>	<p>60 Skud</p> 	<p>11: 10.3x ↗ 12: 10.1 ↙ 13: 9.5 ↙ 14: 10.7x ↗ 15: 9.9 → 16: 10.4x → 17: 9.6 ↓ 18: 10.1 ↓ 19: 10.6x ← 20: 10.5x ←</p> <p>Serie 101.7 Total 202.6</p>
--	---	--	---

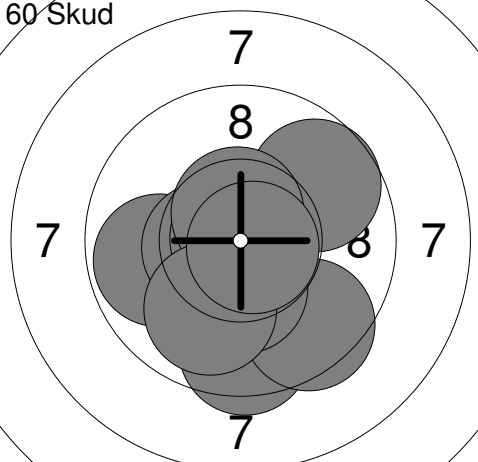
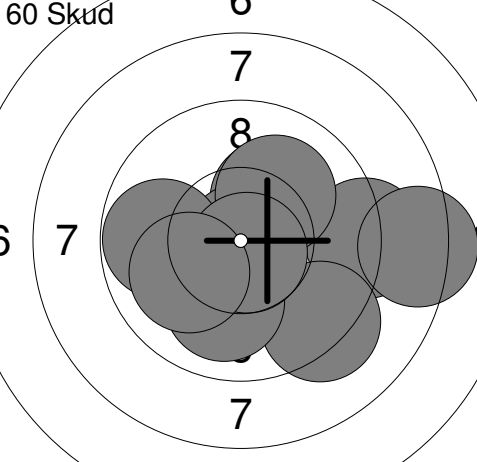
<p>60 Skud</p> 	<p>21: 9.7 ↗ 22: 9.5 ↓ 23: 9.5 ↓ 24: 9.8 ← 25: 10.3x ↓ 26: 10.5x ← 27: 10.9x ↗ 28: 10.6x ↗ 29: 9.9 ↓ 30: 10.8x ↘</p> <p>Serie 101.5 Total 304.1</p>	<p>60 Skud</p> 	<p>31: 10.2x ↗ 32: 9.1 → 33: 10.9x ↘ 34: 10.1 ↗ 35: 9.3 ↘ 36: 9.8 ← 37: 10.0 ↓ 38: 10.7x ↘ 39: 10.0 ↙ 40: 8.3 →</p> <p>Serie 98.4 Total 402.5</p>
---	---	---	---

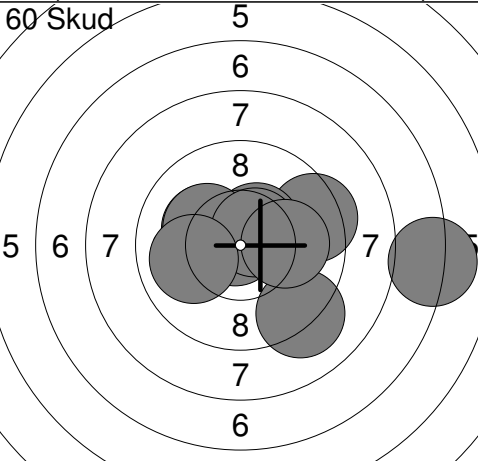
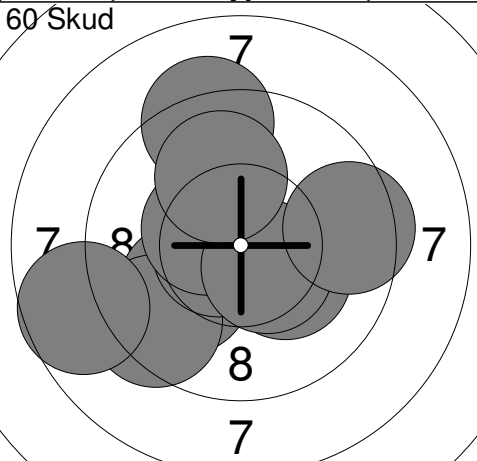
<p>60 Skud</p> 	<p>41: 9.4 → 42: 10.8x ↗ 43: 10.2x ↗ 44: 7.1 → 45: 10.5x ↗ 46: 10.2x ↗ 47: 10.6x ↗ 48: 9.1 ↓ 49: 10.0 → 50: 10.0 ←</p> <p>Serie 97.9 Total 500.4</p>	<p>60 Skud</p> 	<p>51: 10.0 ↙ 52: 9.4 ↙ 53: 10.6x ← 54: 10.4x ↗ 55: 10.2x ↘ 56: 8.7 ↙ 57: 9.2 ↗ 58: 10.5x ↘ 59: 10.0 ↗ 60: 9.5 →</p> <p>Serie 98.5 Total 598.9</p>
---	--	---	--

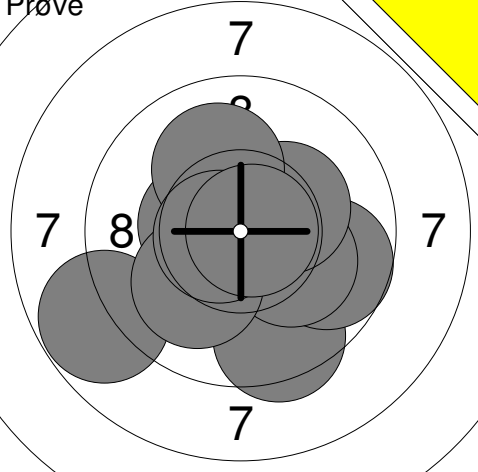
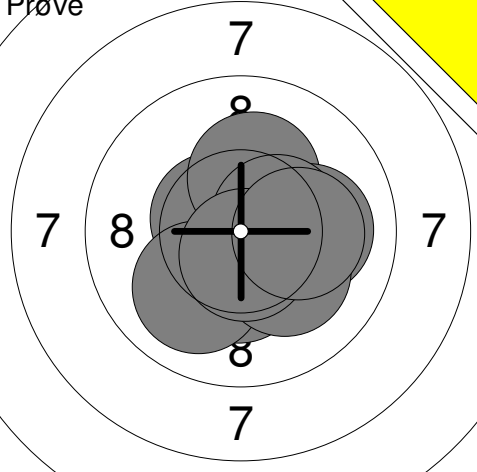
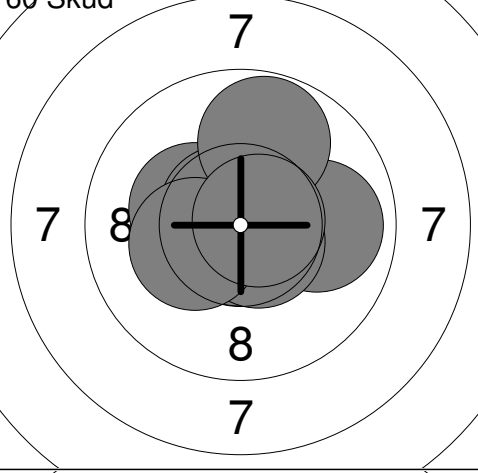
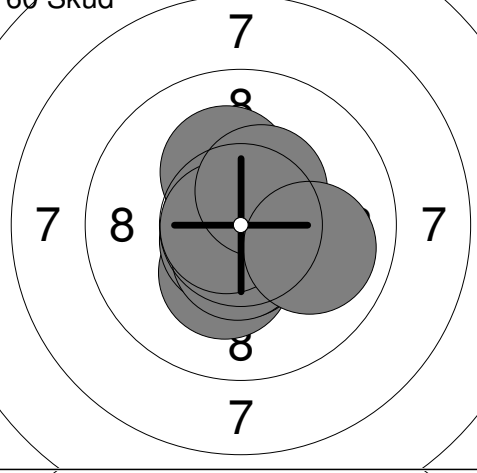
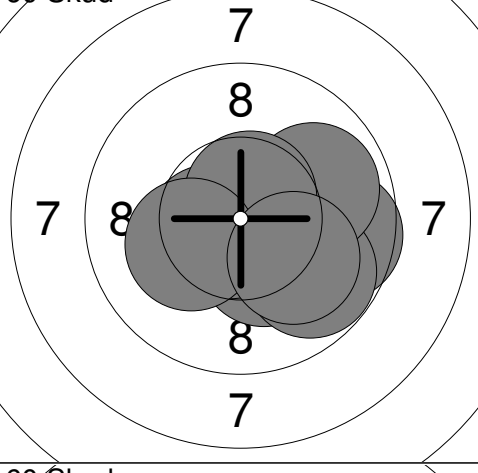
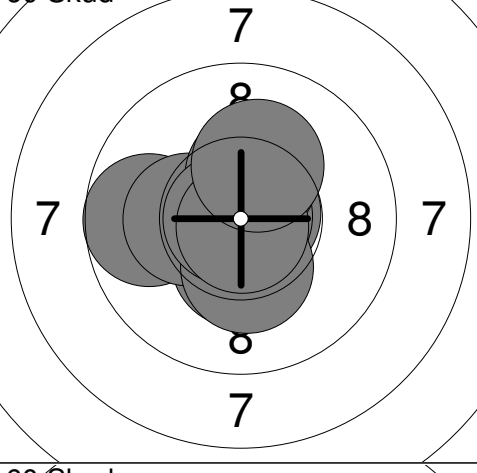
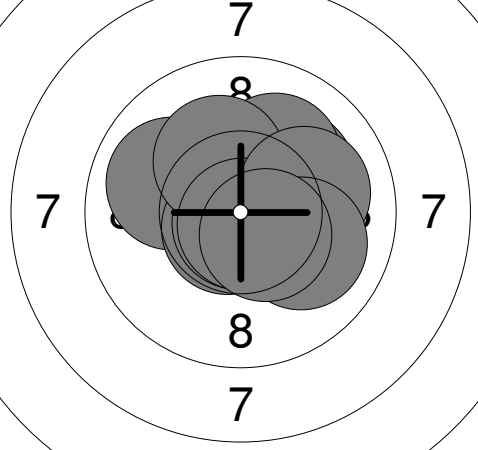
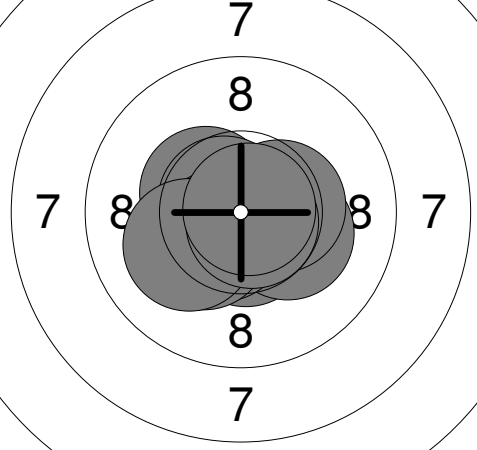
Prøve 	1: 8.8 ↙ 2: 10.5x ← 3: 9.5 ↘ 4: 9.7 → 5: 10.2x ↘ 6: 10.1 ↘ 7: 10.3x → 8: 10.1 ↗ 9: 10.7x ← 10: 10.8x → <hr/> Serie 100.7 Total 0.0	Prøve 	11: 10.6x ↙ 12: 10.2x ↑ 13: 10.0 → 14: 10.3x ↓ 15: 10.0 ↘ 16: 10.2x ↘ 17: 10.4x → 18: 10.6x ↓ 19: 10.2x → <hr/> Serie 92.5 Total 0.0
60 Skud 	1: 9.9 → 2: 10.7x ↗ 3: 10.3x ← 4: 10.8x ↓ 5: 10.6x ↘ 6: 10.7x ↗ 7: 10.7x ↗ 8: 10.3x ← 9: 9.8 ↑ 10: 10.7x → <hr/> Serie 104.5 Total 104.5	60 Skud 	11: 10.8x ← 12: 10.6x ↑ 13: 10.2x ↑ 14: 10.3x ↓ 15: 10.6x ↓ 16: 10.7x ↘ 17: 10.6x ↓ 18: 10.8x ← 19: 10.4x ↗ 20: 10.0 → <hr/> Serie 105.0 Total 209.5
60 Skud 	21: 10.3x ↘ 22: 9.6 → 23: 9.8 ↘ 24: 10.3x → 25: 10.5x ← 26: 10.7x ↘ 27: 9.9 → 28: 10.6x ↗ 29: 10.2x ← 30: 10.1 ↘ <hr/> Serie 102.0 Total 311.5	60 Skud 	31: 9.7 ← 32: 10.8x → 33: 10.4x ↓ 34: 10.9x → 35: 10.3x ← 36: 10.3x ↓ 37: 10.4x ↑ 38: 10.8x ← 39: 10.8x ↓ 40: 10.2x ↑ <hr/> Serie 104.6 Total 416.1
60 Skud 	41: 10.1 ↗ 42: 10.1 ↗ 43: 10.0 ↗ 44: 10.7x ↘ 45: 10.8x ↘ 46: 10.2x ↗ 47: 10.8x ↘ 48: 10.1 → 49: 10.0 → 50: 10.5x ↘ <hr/> Serie 103.3 Total 519.4	60 Skud 	51: 10.4x ↙ 52: 10.7x ↙ 53: 10.6x ↓ 54: 10.3x → 55: 10.4x → 56: 10.6x ↘ 57: 10.3x ↘ 58: 10.1 ← 59: 10.8x ↘ 60: 10.8x → <hr/> Serie 105.0 Total 624.4

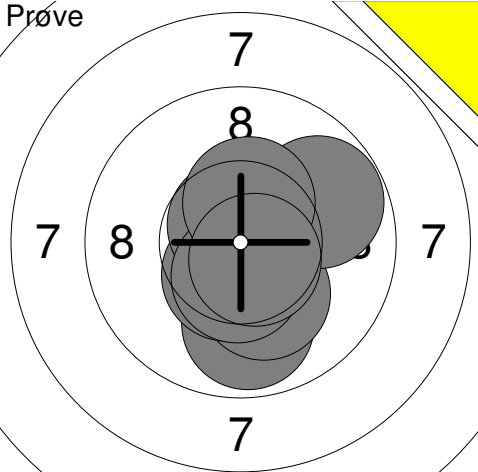
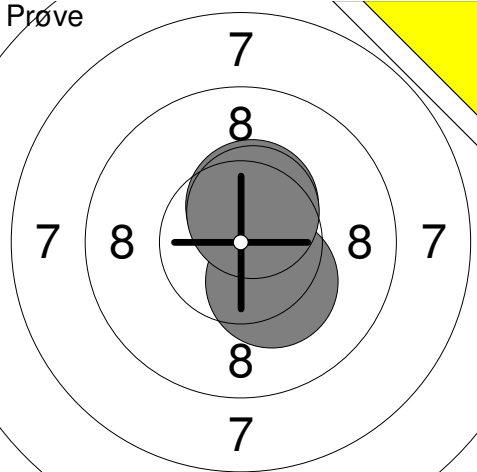
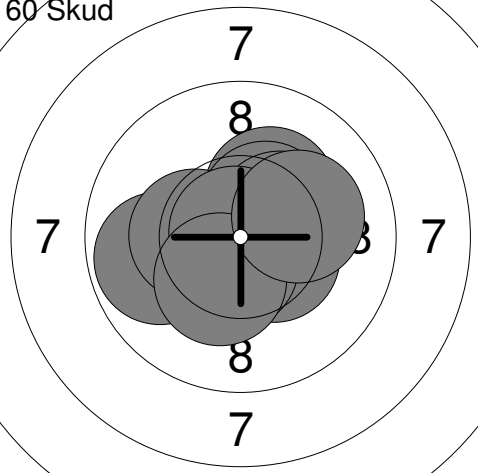
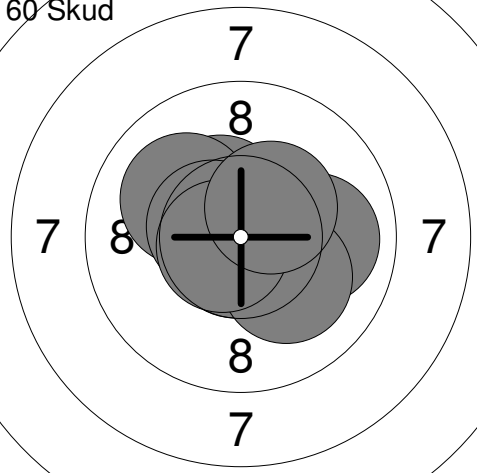
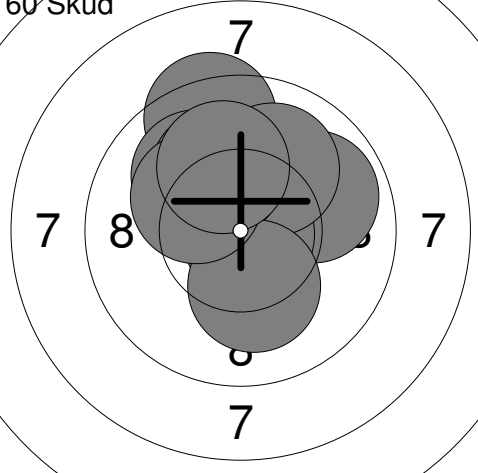
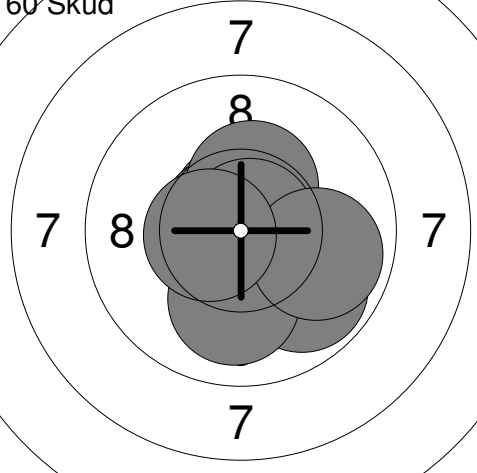
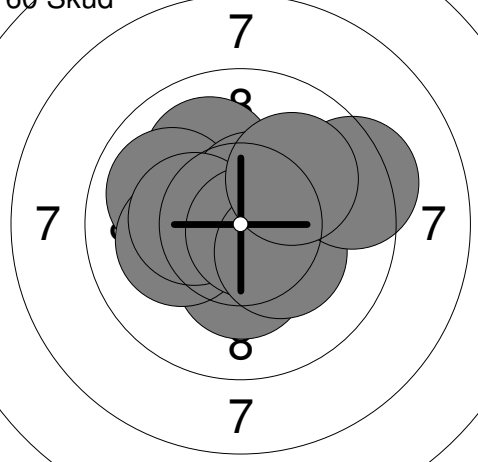
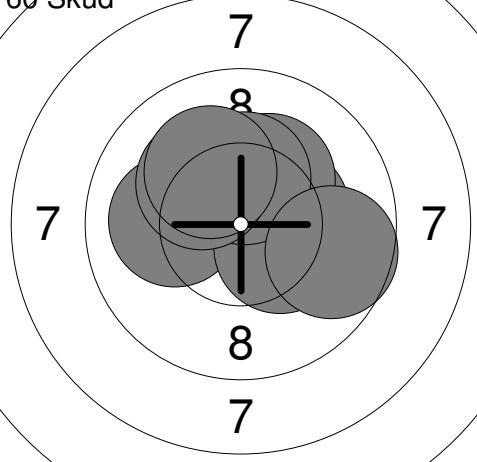
Hold	Skive	Anna Skade			
39	2				
AAS		Særslev			
2016/17		Aalborg Skyttekreds			
Prøve		1: 9.8 ↓ 2: 10.7x ↓ 3: 10.8x ↑ 4: 10.2x ↓ 5: 9.8 → 6: 10.5x ↓ 7: 10.7x ↑ 8: 10.5x ↓ 9: 10.4x ↑ 10: 10.6x ↓ Serie 104.0 Total 0.0	Prøve		11: 10.4x ↑ 12: 10.3x ↓ 13: 10.5x ↑ Serie 31.2 Total 0.0
60 Skud		1: 10.2x ↑ 2: 9.8 ← 3: 10.4x ↑ 4: 10.3x ← 5: 10.4x → 6: 10.4x → 7: 10.6x ↓ 8: 10.9x ↑ 9: 10.3x ↓ 10: 10.1 → Serie 103.4 Total 103.4	60 Skud		11: 10.6x → 12: 10.7x → 13: 10.4x ↑ 14: 10.1 ↑ 15: 10.0 → 16: 10.5x ↑ 17: 10.7x ↓ 18: 10.1 ↓ 19: 10.7x ← 20: 10.4x ↑ Serie 104.2 Total 207.6
60 Skud		21: 10.3x ↑ 22: 9.4 ↑ 23: 9.9 → 24: 10.0 ↑ 25: 10.8x → 26: 10.0 ↑ 27: 10.1 ↑ 28: 10.2x ↓ 29: 10.2x ↑ 30: 10.1 ↑ Serie 101.0 Total 308.6	60 Skud		31: 9.8 ↓ 32: 10.6x ↑ 33: 10.7x ← 34: 10.3x ↑ 35: 10.7x ← 36: 10.8x ↓ 37: 10.8x → 38: 10.0 ↓ 39: 9.9 → 40: 10.5x ← Serie 104.1 Total 412.7
60 Skud		41: 10.0 ↑ 42: 9.9 ← 43: 10.3x ↓ 44: 10.1 ← 45: 10.5x ↑ 46: 10.3x ← 47: 10.8x ↓ 48: 10.3x ↓ 49: 9.3 → 50: 10.0 ↑ Serie 101.5 Total 514.2	60 Skud		51: 10.4x ↑ 52: 10.4x → 53: 10.3x → 54: 10.2x ↑ 55: 10.1 ← 56: 10.3x ↓ 57: 10.3x ↑ 58: 9.7 → 59: 10.2x ↑ 60: 10.1 ↑ Serie 102.0 Total 616.2

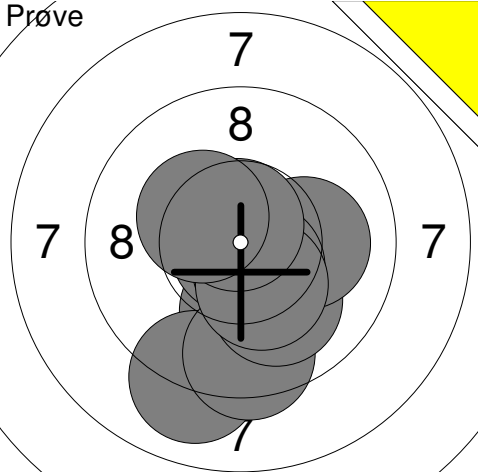
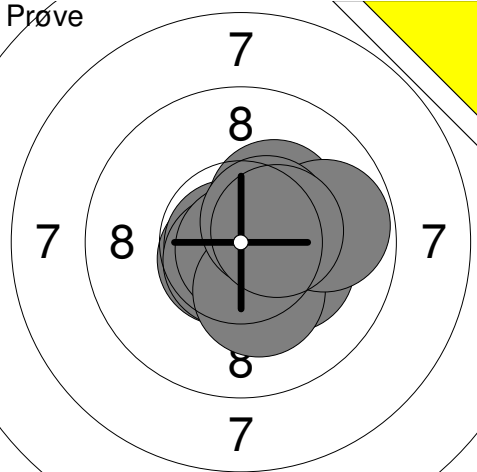
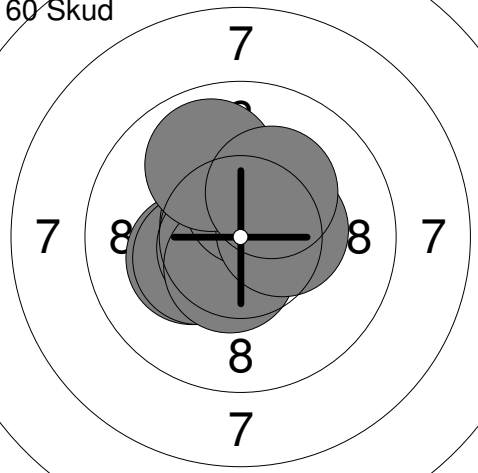
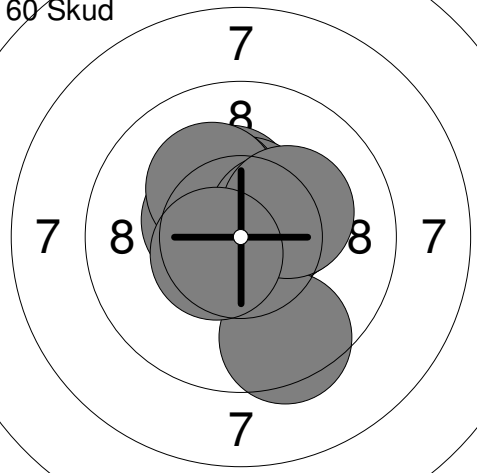
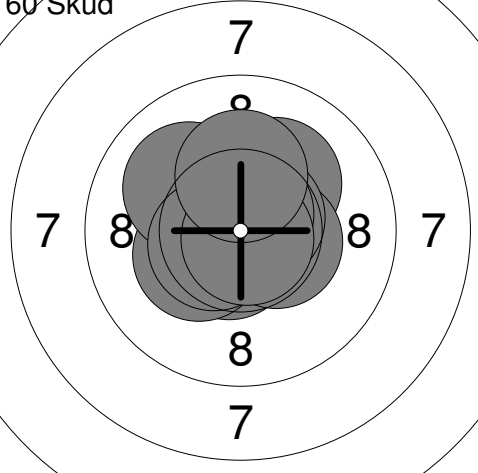
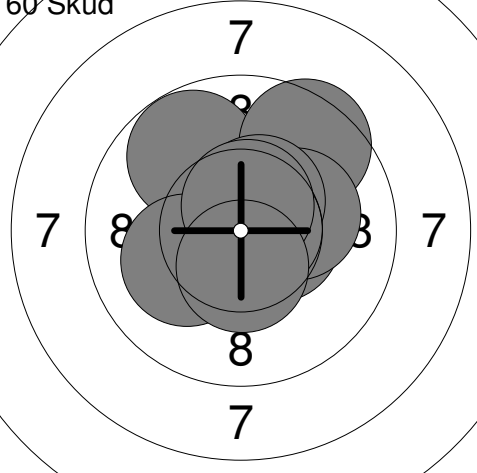
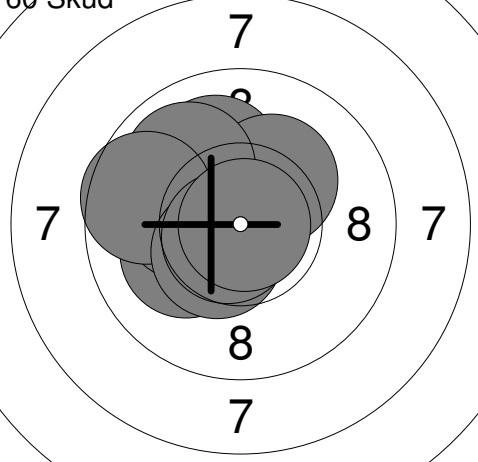
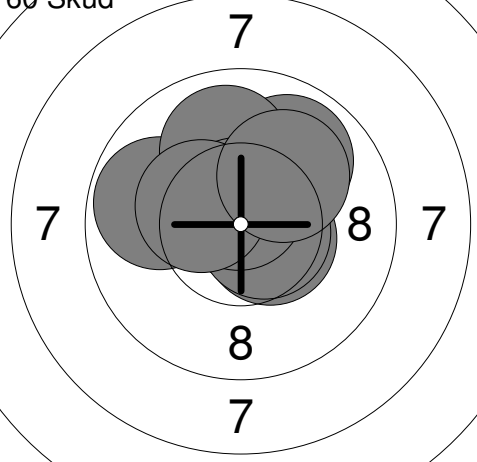
Hold	Skive	Alexander Helleskov			
39	3				
AAS		Trehøje			
2016/17		Aalborg Skyttekreds			
Prøve		1: 10.0 ↓ 2: 10.8x ↓ 3: 9.0 ↓ 4: 9.4 ↓ 5: 10.0 ↓ 6: 10.1 → 7: 10.5x ↓ 8: 10.3x ↓ 9: 10.7x ↑ 10: 10.3x ↗	Prøve		11: 10.6x ↘ 12: 10.8x ← 13: 10.2x → 14: 10.3x ↗ 15: 10.7x ↓ 16: 10.8x ↓ 17: 10.3x ↓ 18: 9.8 → 19: 10.5x ↗ 20: 10.4x →
		Serie 101.1		Serie 104.4	
		Total 0.0		Total 0.0	
60 Skud		1: 10.2x ← 2: 10.3x ← 3: 10.7x ↗ 4: 10.7x ← 5: 10.8x → 6: 10.5x ↓ 7: 10.4x ↑ 8: 10.4x → 9: 9.9 ↗ 10: 10.2x ↗	60 Skud		11: 10.3x ↗ 12: 10.3x ↑ 13: 10.5x ↑ 14: 10.4x ← 15: 10.3x ↑ 16: 10.2x ↑ 17: 10.4x ↗ 18: 9.5 ↓ 19: 10.2x ↗ 20: 10.6x ↘
		Serie 104.1		Serie 102.7	
		Total 104.1		Total 206.8	
60 Skud		21: 10.2x ↗ 22: 10.6x ↓ 23: 10.4x → 24: 10.3x ← 25: 10.7x ↗ 26: 10.7x ↑ 27: 10.0 ↗ 28: 10.5x ← 29: 10.8x ↓ 30: 10.2x ↑	60 Skud		31: 9.8 ↗ 32: 10.7x → 33: 10.5x → 34: 9.5 ↗ 35: 10.1 ← 36: 10.2x → 37: 10.5x ↑ 38: 10.7x → 39: 10.6x ↑ 40: 10.5x ↓
		Serie 104.4		Serie 103.1	
		Total 311.2		Total 414.3	
60 Skud		41: 10.1 ← 42: 10.0 ↗ 43: 10.2x ↗ 44: 10.2x ← 45: 10.7x ← 46: 9.9 ↗ 47: 9.6 ← 48: 10.5x ↓ 49: 10.7x ↓ 50: 10.9x →	60 Skud		51: 10.3x ↑ 52: 10.8x ↑ 53: 10.5x → 54: 9.9 ↗ 55: 9.8 ← 56: 9.9 ↑ 57: 10.6x → 58: 10.7x ↑ 59: 10.4x ← 60: 10.1 ↗
		Serie 102.8		Serie 103.0	
		Total 517.1		Total 620.1	

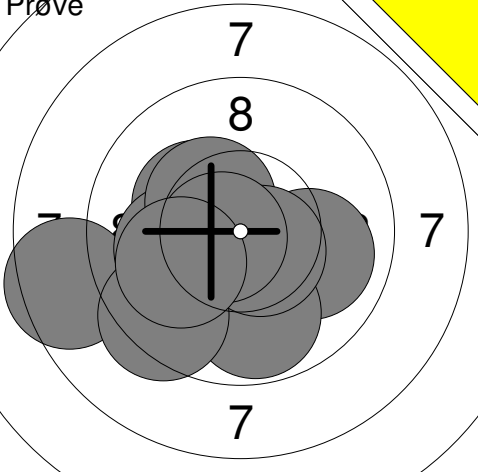
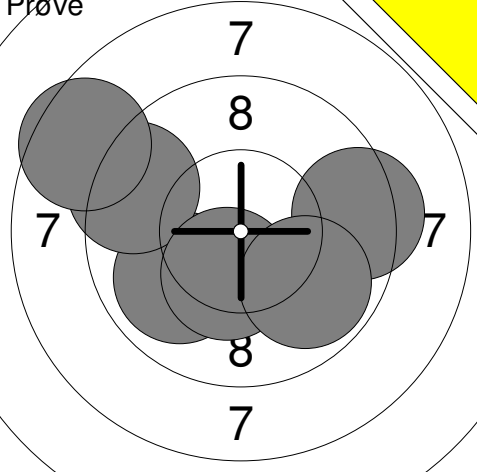
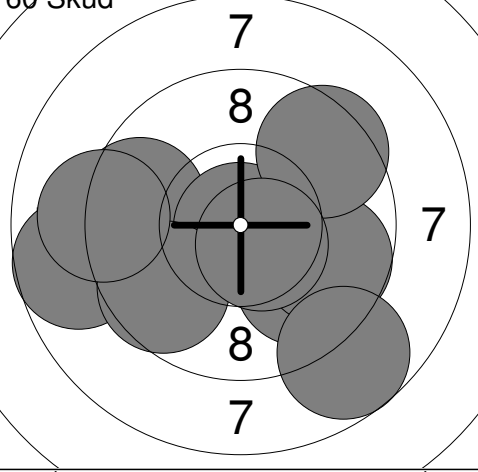
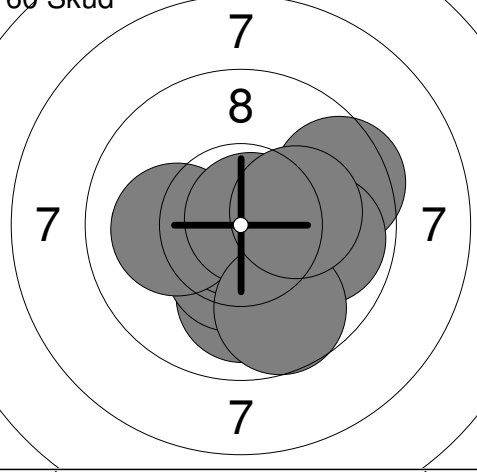
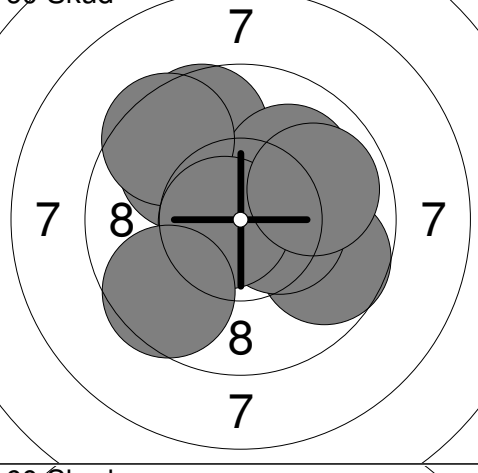
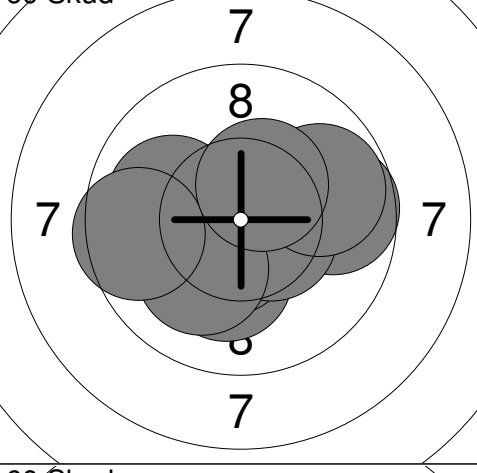
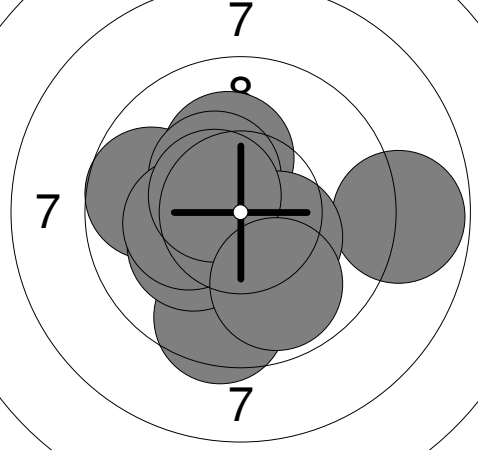
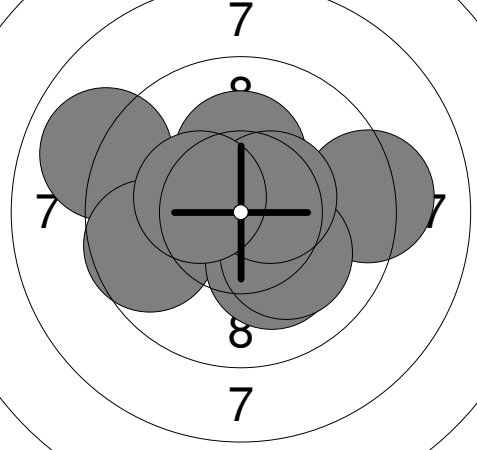
Hold	Skive	Rasmus Hansen	
39	4		
AAS		Særslev	
2016/17		Aalborg Skyttekreds	
Prøve 	1: 8.5 ← 2: 10.0 → 3: 10.3x ↗ 4: 9.8 ↓ 5: 10.1 ← 6: 10.4x ↗ 7: 9.4 ↓ 8: 10.6x ↓ 9: 10.7x ← 10: 10.0 ← Serie 99.8 Total 0.0	Prøve 	11: 9.9 ↙ 12: 9.3 → 13: 9.4 ↗ 14: 8.5 ↗ 15: 10.4x ↓ 16: 9.8 ↓ Serie 57.3 Total 0.0
60 Skud 	1: 9.6 ← 2: 10.9x ↓ 3: 9.8 ↓ 4: 9.7 → 5: 9.5 ↗ 6: 8.7 ← 7: 9.6 ↓ 8: 8.7 ↓ 9: 9.1 ← 10: 10.6x ↓ Serie 96.2 Total 96.2	60 Skud 	11: 10.0 ↓ 12: 10.4x ↓ 13: 10.3x ↓ 14: 10.9x ↓ 15: 10.1 ← 16: 10.8x ↗ 17: 9.5 ↗ 18: 9.9 → 19: 9.7 ↓ 20: 10.2x → Serie 101.8 Total 198.0
60 Skud 	21: 10.8x → 22: 9.7 → 23: 9.9 ↗ 24: 9.6 ↗ 25: 10.0 ↗ 26: 9.5 ↗ 27: 10.4x → 28: 10.7x ← 29: 9.9 → 30: 9.6 ↓ Serie 100.1 Total 298.1	60 Skud 	31: 10.2x ↓ 32: 10.5x ↓ 33: 9.7 → 34: 10.4x ← 35: 10.0 ← 36: 10.5x → 37: 10.1 ↓ 38: 9.6 ← 39: 9.8 → 40: 10.4x ↗ Serie 101.2 Total 399.3
60 Skud 	41: 8.8 → 42: 9.7 ← 43: 9.5 ↓ 44: 10.2x ↗ 45: 10.2x ← 46: 10.4x ↗ 47: 10.2x ← 48: 10.4x ↓ 49: 10.5x ↗ 50: 9.9 ↓ Serie 99.8 Total 499.1	60 Skud 	51: 10.5x → 52: 9.0 ↙ 53: 10.2x ↓ 54: 9.2 → 55: 10.2x ↑ 56: 9.6 ← 57: 10.1 ↓ 58: 10.1 ↓ 59: 10.5x → 60: 10.4x ← Serie 99.8 Total 598.9

Hold	Skive	Mette Sørensen	
39	5		
AAS		Trehøje	
2016/17		Aalborg Skyttekreds	
Prøve 	1: 9.4 → 2: 10.1 → 3: 10.4x ↗ 4: 10.1 ↘ 5: 10.1 ↗ 6: 9.6 ↘ 7: 9.3 ↘ 8: 9.4 ↘ 9: 10.3x ↘ 10: 9.8 ←	Prøve 	11: 10.2x ↘ 12: 9.8 → 13: 9.0 ← 14: 9.7 ← 15: 10.0 ↗ 16: 10.1 ↖
Serie 98.5		Serie 58.8	
Total 0.0		Total 0.0	
60 Skud 	1: 10.8x ↖ 2: 10.2x ↗ 3: 10.5x ↗ 4: 9.7 → 5: 10.2x ↘ 6: 10.1 ← 7: 10.4x ↗ 8: 10.4x ↗ 9: 10.5x ↖ 10: 9.5 →	60 Skud 	11: 10.1 ↗ 12: 9.4 ↖ 13: 10.0 ← 14: 10.5x ↗ 15: 9.1 ← 16: 9.7 ↗ 17: 9.9 ↗ 18: 10.1 ↗ 19: 9.7 ↘ 20: 9.9 →
Serie 102.3		Serie 98.4	
Total 102.3		Total 200.7	
60 Skud 	21: 9.8 → 22: 10.7x ↖ 23: 9.9 → 24: 9.4 ↗ 25: 9.9 ↗ 26: 10.3x ↖ 27: 9.1 ↘ 28: 9.9 ↘ 29: 10.6x ↗ 30: 10.5x ↘	60 Skud 	31: 9.8 ← 32: 9.8 ↗ 33: 10.5x ↗ 34: 9.7 ← 35: 10.1 → 36: 7.8 → 37: 10.0 ← 38: 10.8x ↗ 39: 10.3x ↖ 40: 10.7x ↗
Serie 100.1		Serie 99.5	
Total 300.8		Total 400.3	
60 Skud 	41: 10.5x ↘ 42: 9.7 → 43: 9.6 ↗ 44: 10.1 ← 45: 10.1 ↗ 46: 10.6x ↘ 47: 10.6x ↖ 48: 10.8x → 49: 9.9 ↗ 50: 10.1 ↘	60 Skud 	51: 9.2 ↖ 52: 10.2x ↗ 53: 10.2x ↗ 54: 10.0 ↗ 55: 10.8x ← 56: 10.8x ↗ 57: 10.1 ← 58: 10.3x ↗ 59: 10.4x → 60: 10.7x ←
Serie 102.0		Serie 102.7	
Total 502.3		Total 605.0	

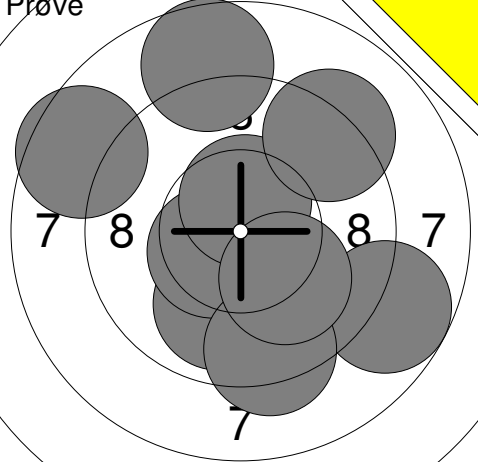
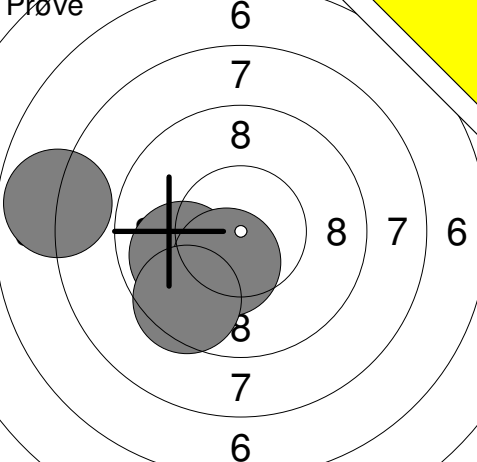
Prøve 	1: 9.9 ↓ 2: 10.0 ↓ 3: 8.7 → 4: 10.5x ← 5: 10.5x ↑ 6: 8.6 → 7: 9.3 ↓ 8: 8.7 ↑ 9: 9.2 → 10: 10.1 ↓	Prøve 	11: 9.9 ← 12: 7.9 ← 13: 10.4x ↓ 14: 9.5 ↓
	Serie 95.5		Serie 37.7
	Total 0.0		Total 0.0

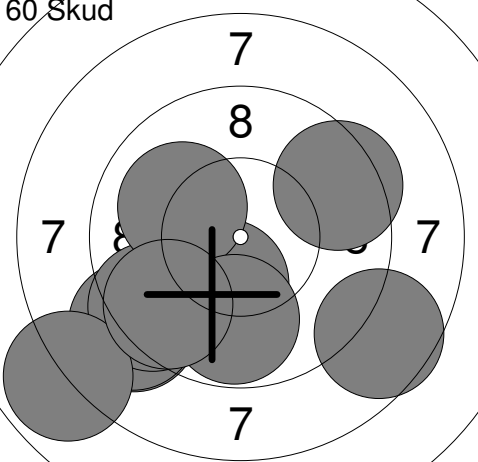
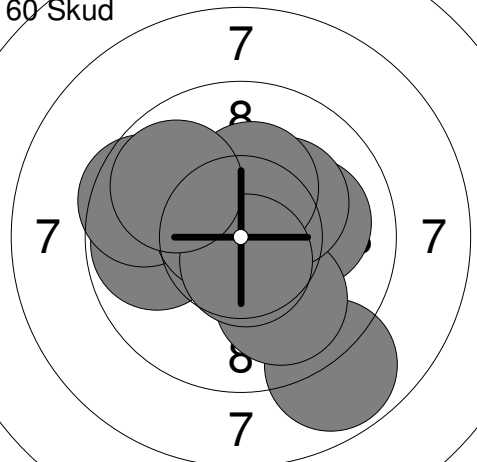
60 Skud 	1: 9.4 → 2: 10.3x ↓ 3: 9.0 ← 4: 9.0 ← 5: 8.6 → 6: 9.4 ← 7: 10.0 → 8: 7.9 ← 9: 9.8 ↓ 10: 9.6 ←	60 Skud 	11: 9.8 ← 12: 9.6 ← 13: 8.8 ↓ 14: 10.1 → 15: 10.0 ↓ 16: 10.6x ↑ 17: 10.2x → 18: 10.3x ↑ 19: 10.6x ↓ 20: 9.8 →
	Serie 93.0		Serie 99.8
	Total 93.0		Total 192.8

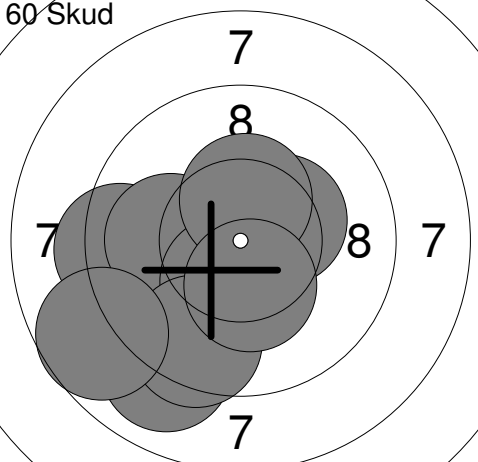
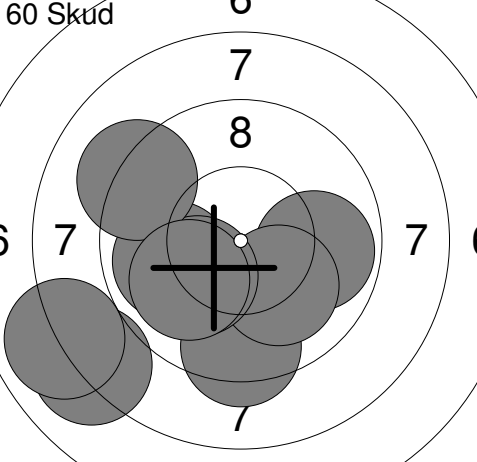
60 Skud 	21: 9.3 ← 22: 10.3x → 23: 10.4x ↓ 24: 9.0 ↓ 25: 10.0 ← 26: 10.4x ↓ 27: 9.5 ↓ 28: 10.4x ↑ 29: 8.7 ← 30: 10.3x ↓	60 Skud 	31: 10.0 ↓ 32: 8.1 ← 33: 9.8 → 34: 8.0 ← 35: 9.4 ↓ 36: 10.1 ↓ 37: 9.9 ← 38: 10.1 ← 39: 9.2 → 40: 10.0 ←
	Serie 98.3		Serie 94.6
	Total 291.1		Total 385.7

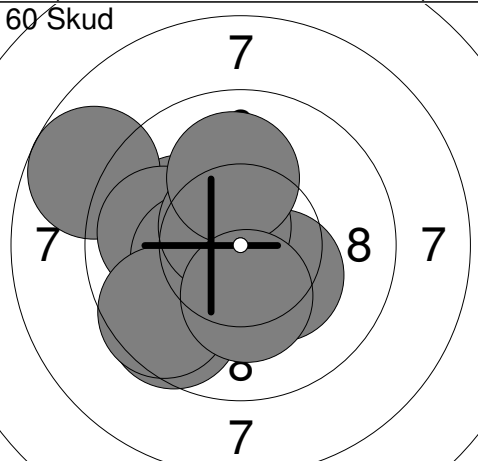
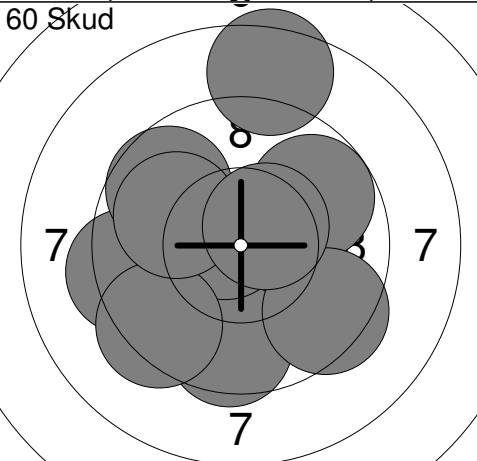
60 Skud 	41: 10.1 → 42: 8.7 → 43: 9.6 ↓ 44: 10.3x ↓ 45: 9.9 ← 46: 10.3x ← 47: 9.6 ← 48: 10.6x ↑ 49: 10.0 ↑ 50: 10.3x ↓	60 Skud 	51: 9.3 ← 52: 9.8 → 53: 9.6 ↓ 54: 10.7x → 55: 9.3 ↓ 56: 9.4 ↓ 57: 9.7 → 58: 9.9 → 59: 8.5 ↑ 60: 10.5x →
	Serie 99.4		Serie 96.7
	Total 485.1		Total 581.8

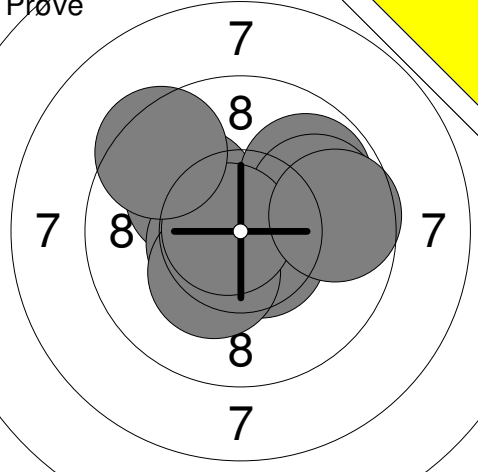
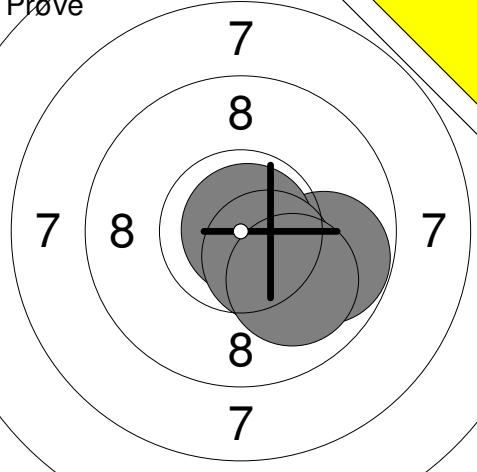
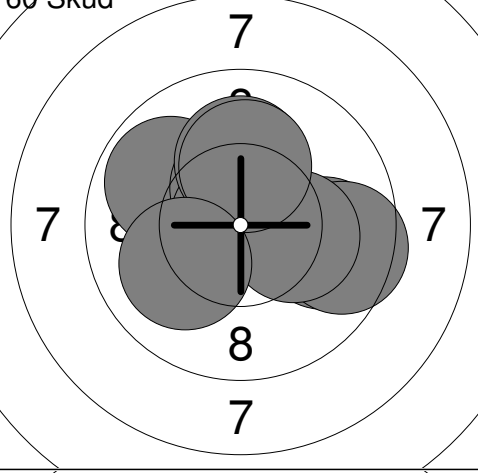
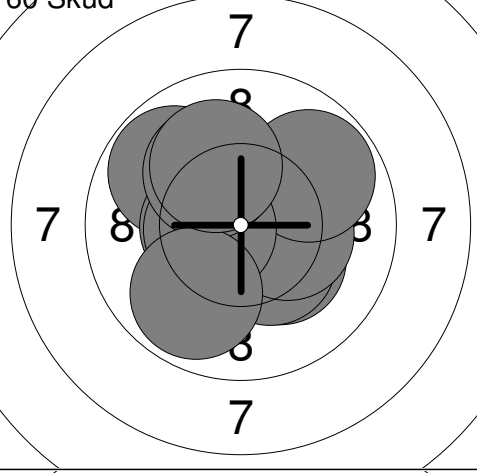
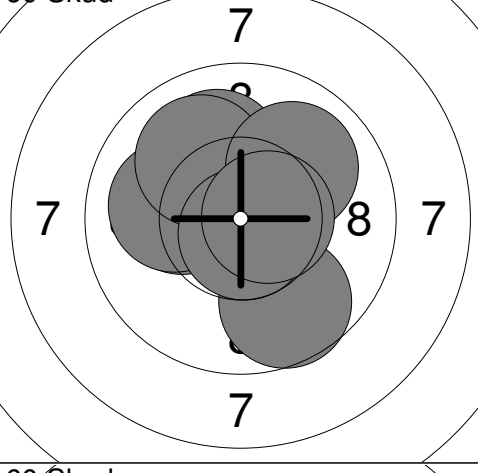
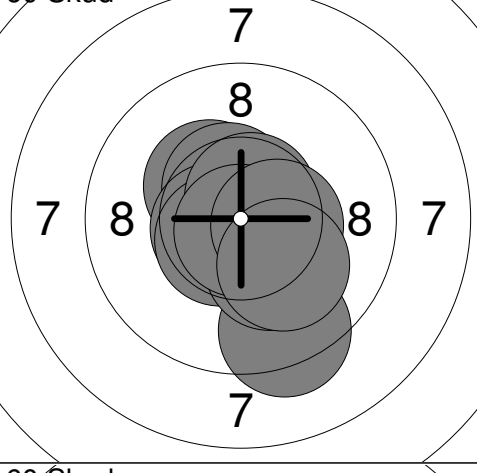
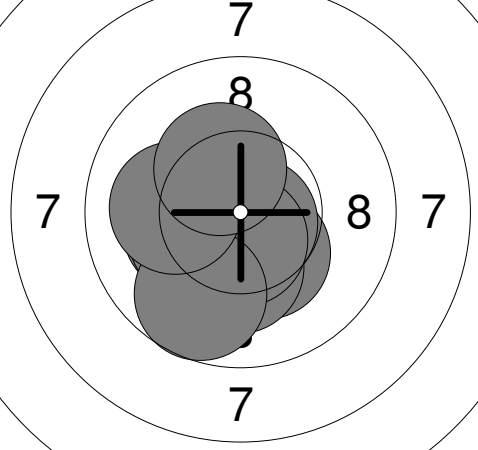
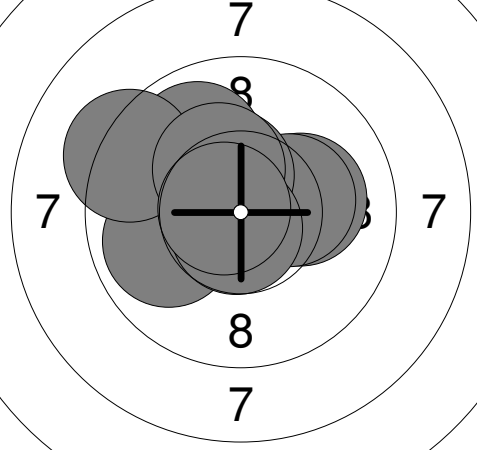
Prøve 	1: 10.4x ↘ 2: 10.1 ↗ 3: 10.6x ↘ 4: 9.8 ↗ 5: 10.5x ↙ 6: 10.3x ↘ 7: 9.9 ↗ 8: 10.8x ↙ 9: 9.7 ↗ 10: 9.4 ↗ <hr/> Serie 101.5 Total 0.0	Prøve 	11: 9.8 ↗ 12: 10.9x → 13: 10.5x ↘ 14: 10.0 ↘ <hr/> Serie 41.2 Total 0.0
60 Skud 	1: 9.8 → 2: 9.5 → 3: 10.5x ← 4: 9.8 ↗ 5: 10.4x ↗ 6: 10.9x ↗ 7: 10.2x → 8: 10.1 ↗ 9: 10.2x ↗ 10: 10.0 ↘ <hr/> Serie 101.4 Total 101.4	60 Skud 	11: 10.3x ↘ 12: 9.8 ↗ 13: 10.5x ← 14: 10.3x ↘ 15: 10.3x → 16: 9.8 ↗ 17: 10.5x ← 18: 10.1 ↗ 19: 9.9 ↘ 20: 10.1 ↗ <hr/> Serie 101.6 Total 203.0
60 Skud 	21: 10.6x → 22: 10.7x ↗ 23: 10.1 ← 24: 10.0 ↗ 25: 10.0 ← 26: 10.0 ↗ 27: 10.0 ↗ 28: 9.7 ↘ 29: 10.7x ↘ 30: 10.6x → <hr/> Serie 102.4 Total 305.4	60 Skud 	31: 9.3 ↘ 32: 10.3x ↗ 33: 10.5x ↗ 34: 10.6x ← 35: 10.6x ↘ 36: 10.2x ↘ 37: 10.6x ↗ 38: 10.8x ↘ 39: 10.5x → 40: 10.1 ↘ <hr/> Serie 103.5 Total 408.9
60 Skud 	41: 10.3x ↘ 42: 10.2x ← 43: 10.3x ← 44: 10.7x ↗ 45: 10.7x ↘ 46: 10.2x ↘ 47: 10.6x ↘ 48: 9.7 ↘ 49: 10.1 ← 50: 10.3x ↗ <hr/> Serie 103.1 Total 512.0	60 Skud 	51: 9.9 ↗ 52: 10.7x ↗ 53: 10.1 → 54: 9.9 ↙ 55: 10.3x → 56: 9.3 ↗ 57: 10.4x ↗ 58: 10.3x ↗ 59: 10.7x ↘ 60: 10.7x ← <hr/> Serie 102.3 Total 614.3

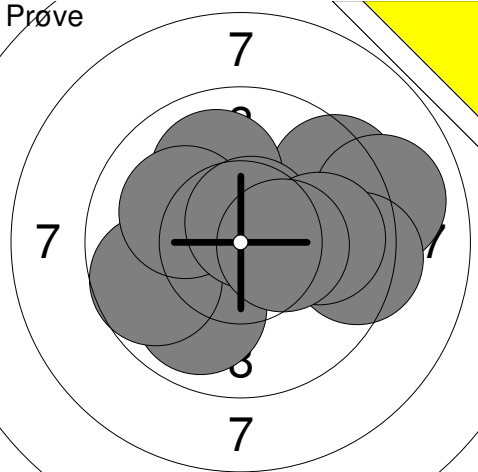
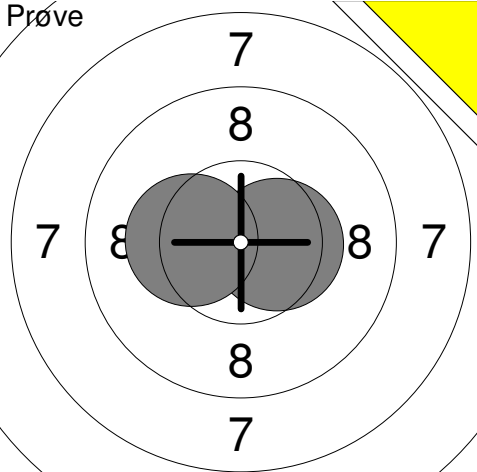
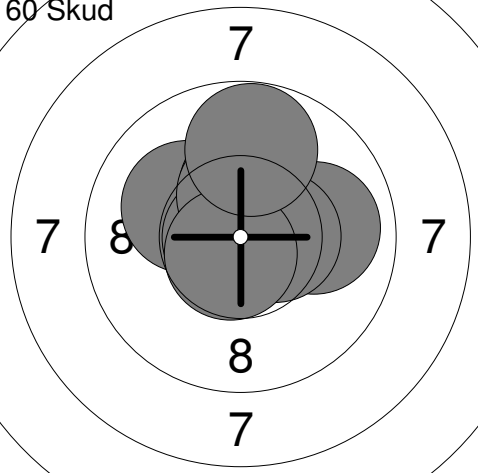
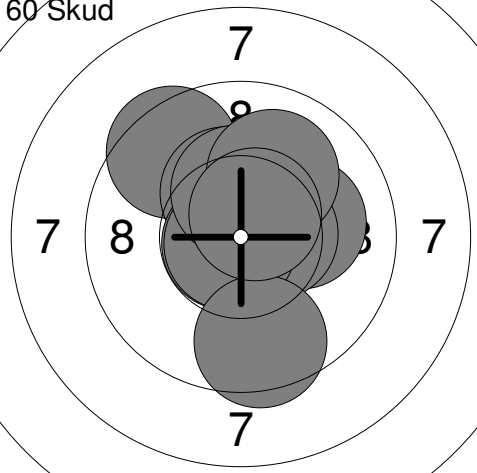
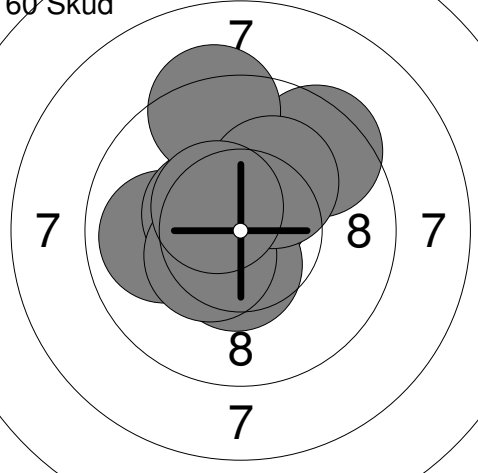
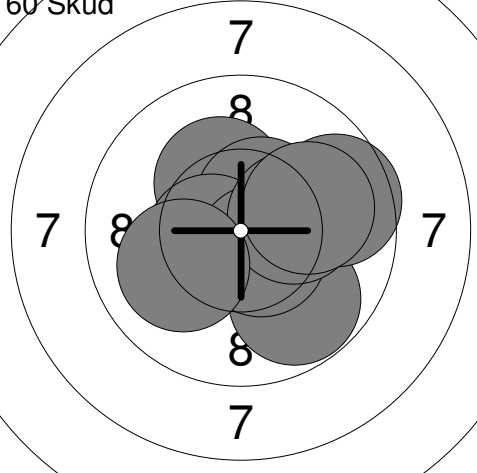
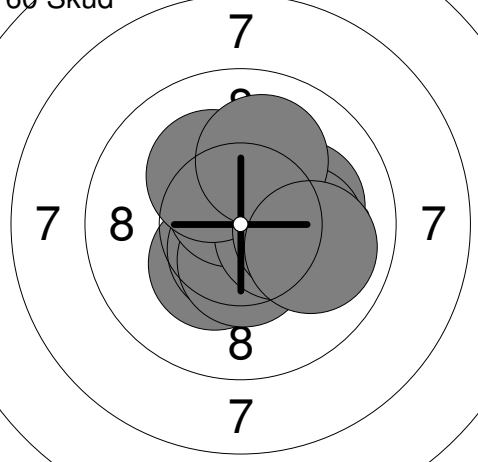
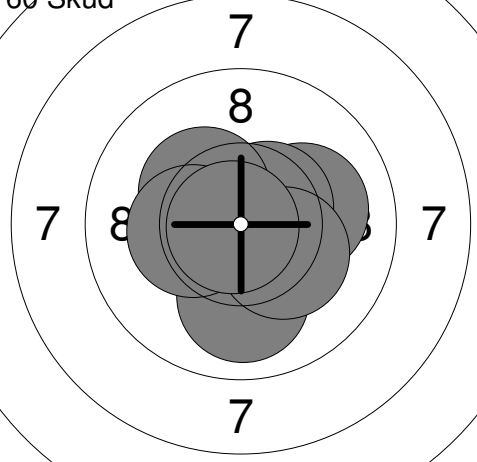
Hold	Skive	Lars Ørum	
39	8		
AAS		Aalborg Skyttekreds	
2016/17		Aalborg Skyttekreds	
Prøve 	1: 9.4 → 2: 9.9 ↓ 3: 9.0 → 4: 9.7 ← 5: 10.0 ↑ 6: 10.1 ↗ 7: 10.6x ↗ 8: 9.4 → 9: 9.9 → 10: 10.4x → Serie 98.4 Total 0.0	Prøve 	11: 10.5x → 12: 10.3x ← Serie 20.8 Total 0.0
60 Skud 	1: 10.1 ↖ 2: 10.7x ↑ 3: 10.3x ↑ 4: 10.8x ← 5: 10.7x ↗ 6: 10.0 → 7: 10.4x ↑ 8: 10.5x → 9: 10.7x ↓ 10: 9.8 ↑ Serie 104.0 Total 104.0	60 Skud 	11: 10.1 → 12: 10.5x → 13: 9.5 ↗ 14: 10.3x ↑ 15: 10.8x ← 16: 10.8x ← 17: 10.3x ↑ 18: 9.5 ↓ 19: 10.0 ↗ 20: 10.6x ↗ Serie 102.4 Total 206.4
60 Skud 	21: 9.9 ← 22: 10.6x ↑ 23: 9.5 ↗ 24: 10.5x ↓ 25: 10.5x ↖ 26: 10.3x ↑ 27: 9.3 ↑ 28: 10.4x ↖ 29: 10.2x ↗ 30: 10.5x ↖ Serie 101.7 Total 308.1	60 Skud 	31: 9.8 ↓ 32: 10.6x → 33: 10.3x ↗ 34: 10.5x ↗ 35: 10.5x ← 36: 10.6x ↓ 37: 10.2x → 38: 10.0 ← 39: 9.6 → 40: 10.0 → Serie 102.1 Total 410.2
60 Skud 	41: 10.3x ↓ 42: 10.6x ↓ 43: 10.5x ↓ 44: 10.6x ↗ 45: 10.4x → 46: 10.2x ↗ 47: 10.1 → 48: 10.2x → 49: 10.0 ↑ 50: 10.0 → Serie 102.9 Total 513.1	60 Skud 	51: 10.4x ↓ 52: 10.9x ↓ 53: 10.1 → 54: 10.7x → 55: 10.5x ↗ 56: 10.0 ↓ 57: 10.3x ↗ 58: 10.3x ← 59: 10.3x ↓ 60: 10.8x ← Serie 104.3 Total 617.4

Hold	Skive	Nanna Bissø	
39	9		
AAS		ÅRK	
2016/17		Aalborg Skyttekreds	
Prøve 	1: 10.4x ↗ 2: 10.1 ← 3: 9.8 → 4: 10.3x ↘ 5: 9.6 ← 6: 9.5 ↑ 7: 10.6x ↘ 8: 10.6x ↗ 9: 10.2x ← 10: 10.8x ↗	Prøve 	11: 10.9x ↘ 12: 10.2x ↘ 13: 10.8x ↘ 14: 10.0 ↗ 15: 10.3x ↗
	Serie 101.9		Serie 52.2
	Total 0.0		Total 0.0
60 Skud 	1: 10.6x ↗ 2: 10.2x ← 3: 10.3x ↗ 4: 9.8 ↗ 5: 10.7x ← 6: 10.2x ↘ 7: 10.8x ↗ 8: 9.9 → 9: 9.9 ↗ 10: 10.3x ↘	60 Skud 	11: 9.6 → 12: 10.5x ↘ 13: 10.3x ↗ 14: 10.4x ↑ 15: 10.2x → 16: 10.6x ↘ 17: 10.2x → 18: 9.9 ↘ 19: 10.3x ↗ 20: 10.4x →
	Serie 102.7		Serie 102.4
	Total 102.7		Total 205.1
60 Skud 	21: 8.5 ← 22: 9.6 → 23: 9.8 → 24: 10.3x ↘ 25: 10.1 → 26: 10.7x ← 27: 10.4x ↘ 28: 10.2x ← 29: 10.2x → 30: 10.8x ↘	60 Skud 	31: 10.0 ↘ 32: 10.3x ↑ 33: 10.4x ↗ 34: 10.3x → 35: 10.4x ↗ 36: 9.9 ← 37: 10.5x ↘ 38: 10.3x ↘ 39: 10.5x ← 40: 9.8 ←
	Serie 100.6		Serie 102.4
	Total 305.7		Total 408.1
60 Skud 	41: 10.1 ↘ 42: 9.7 ← 43: 9.7 ↑ 44: 10.4x → 45: 9.2 ↘ 46: 10.5x → 47: 9.7 → 48: 10.6x → 49: 10.6x → 50: 10.0 →	60 Skud 	51: 10.3x → 52: 9.6 ↘ 53: 10.3x ← 54: 9.9 ← 55: 9.8 ↘ 56: 10.6x ↘ 57: 10.5x ← 58: 9.7 ↘ 59: 10.6x → 60: 10.5x ↗
	Serie 100.5		Serie 101.8
	Total 508.6		Total 610.4

Hold	Skive	Emil L Nielsen	
39	10	Aalborg Skyttekreds	
AAS		2016/17	
Aalborg Skyttekreds		Aalborg Skyttekreds	
Prøve 	1: 9.1 ↗ 2: 10.4x ← 3: 10.5x ↘ 4: 9.4 ↘ 5: 10.0 → 6: 10.5x ↘ 7: 10.0 ← 8: 9.8 ↗ 9: 9.8 ↘ 10: 9.5 ↘ Serie 99.0 Total 0.0	Prøve 	11: 9.8 ← 12: 9.8 ↘ 13: 10.4x → 14: 9.0 ↘ 15: 10.0 ↘ 16: 9.2 ↘ 17: 9.9 ↘ Serie 68.1 Total 0.0
60 Skud 	1: 10.5x ← 2: 9.7 ↘ 3: 9.7 ↘ 4: 10.1 ↘ 5: 9.7 ↘ 6: 9.7 → 7: 9.8 → 8: 10.4x → 9: 9.9 ↘ 10: 10.4x ↗ Serie 99.9 Total 99.9	60 Skud 	11: 10.5x ← 12: 9.3 ← 13: 9.9 ↗ 14: 10.4x → 15: 9.0 ↘ 16: 10.1 → 17: 10.6x ↘ 18: 10.7x ↗ 19: 10.1 → 20: 10.4x ↗ Serie 101.0 Total 200.9
60 Skud 	21: 9.7 ↘ 22: 9.6 ← 23: 10.3x ↘ 24: 10.6x ↘ 25: 10.5x ↗ 26: 10.4x ← 27: 9.3 ← 28: 10.1 → 29: 9.9 ↘ 30: 10.0 → Serie 100.4 Total 301.3	60 Skud 	31: 10.3x ← 32: 10.7x → 33: 10.4x → 34: 9.3 ↘ 35: 9.8 ↘ 36: 10.8x → 37: 10.5x → 38: 10.5x ↑ 39: 10.1 → 40: 10.6x ↘ Serie 103.0 Total 404.3
60 Skud 	41: 10.2x ↘ 42: 10.6x ↘ 43: 10.4x ← 44: 9.9 ← 45: 9.5 ↗ 46: 10.0 ↗ 47: 8.9 ← 48: 10.3x ↗ 49: 10.2x → 50: 10.4x → Serie 100.4 Total 504.7	60 Skud 	51: 10.1 ↑ 52: 10.6x → 53: 9.4 → 54: 9.1 → 55: 10.0 ↘ 56: 10.4x ↘ 57: 9.8 ↗ 58: 10.3x ↘ 59: 10.5x ↘ 60: 10.6x ↘ Serie 100.8 Total 605.5

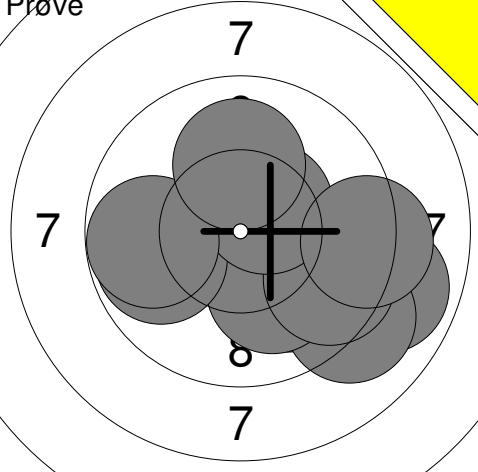
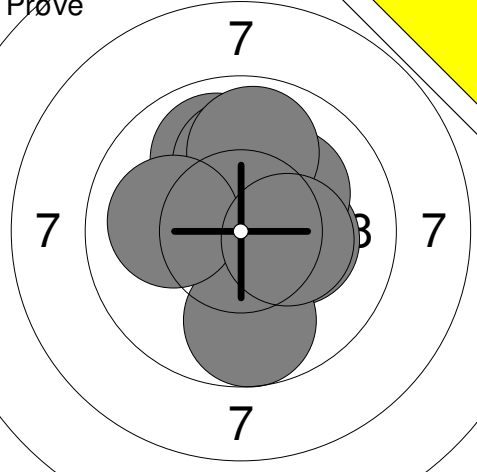
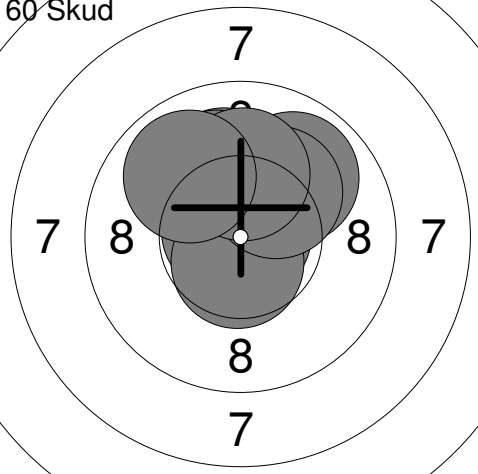
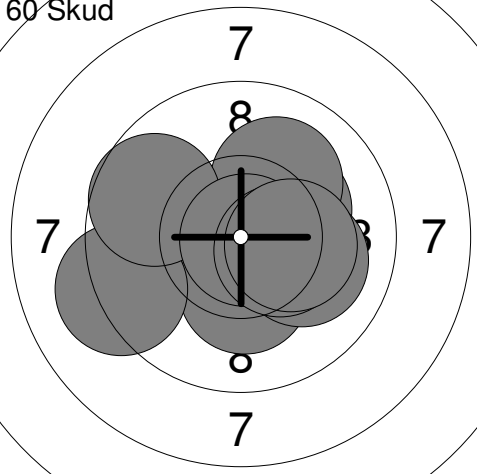
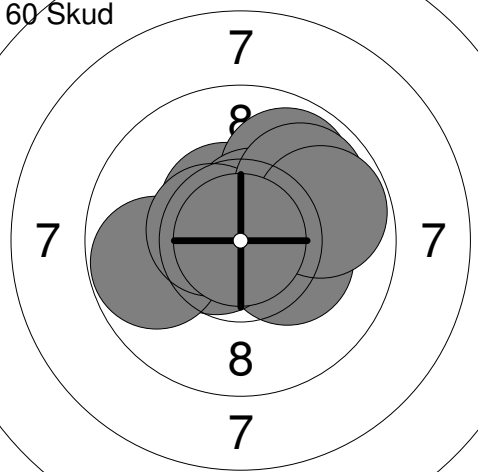
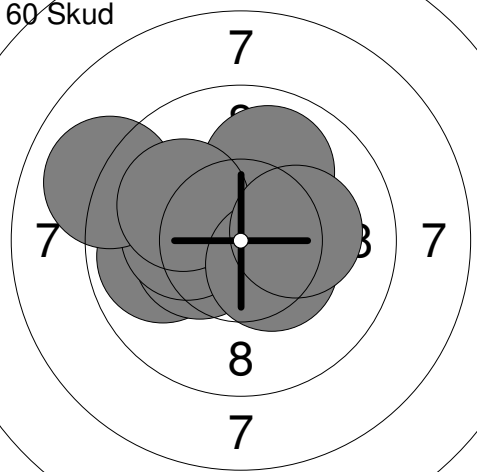
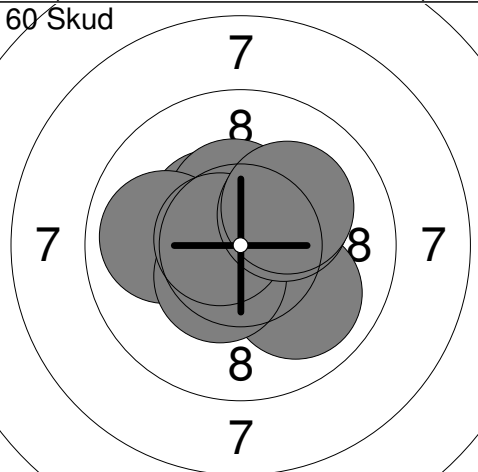
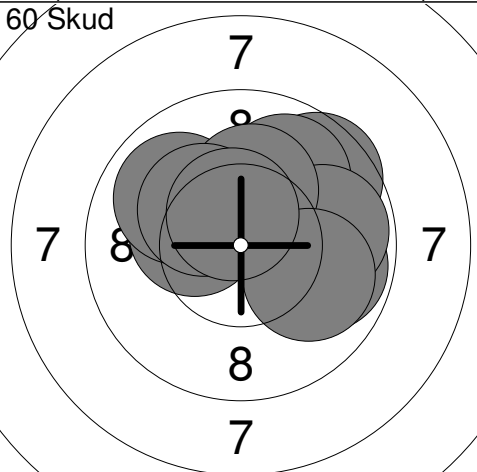
Prøve 	1: 10.0 ↘ 2: 8.9 → 3: 9.1 ↘ 4: 10.1 ↘ 5: 9.6 ↘ 6: 9.8 ← 7: 10.5x ↗ 8: 9.2 → 9: 9.8 ← 10: 10.0 ↑ <hr/> Serie 97.0 Total 0.0	Prøve 	11: 10.2x → 12: 10.2x ↗ 13: 10.4x ↗ 14: 10.8x → 15: 9.9 ↑ 16: 10.0 ↑ 17: 9.9 ↑ 18: 9.7 ↓ 19: 10.0 ← 20: 10.3x → <hr/> Serie 101.4 Total 0.0
60 Skud 	1: 10.8x ← 2: 10.9x ↗ 3: 9.9 ↗ 4: 10.5x ↑ 5: 10.1 ↑ 6: 10.1 ↑ 7: 10.6x ↓ 8: 10.2x ↗ 9: 10.1 ↑ 10: 9.9 ↗ <hr/> Serie 103.1 Total 103.1	60 Skud 	11: 10.6x ← 12: 10.3x ↓ 13: 10.2x ↗ 14: 10.1 ↗ 15: 9.2 ← 16: 10.1 → 17: 9.7 ↗ 18: 10.9x ↘ 19: 10.4x → 20: 10.3x → <hr/> Serie 101.8 Total 204.9
60 Skud 	21: 10.3x → 22: 10.5x ↗ 23: 10.6x ← 24: 9.9 ↗ 25: 9.8 ← 26: 10.6x ↗ 27: 10.5x ← 28: 9.9 ↗ 29: 9.8 → 30: 10.9x ↗ <hr/> Serie 102.8 Total 307.7	60 Skud 	31: 9.9 ← 32: 10.4x ↗ 33: 10.4x ← 34: 10.2x ← 35: 10.6x ↑ 36: 9.0 ← 37: 10.0 ↑ 38: 10.0 ↗ 39: 10.4x ↘ 40: 10.2x → <hr/> Serie 101.1 Total 408.8
60 Skud 	41: 10.0 ↘ 42: 10.6x ← 43: 10.4x ↗ 44: 10.8x ↑ 45: 10.4x ↑ 46: 9.9 ← 47: 10.5x ↘ 48: 10.7x ← 49: 10.2x ↗ 50: 10.1 ↗ <hr/> Serie 103.6 Total 512.4	60 Skud 	51: 9.6 ↗ 52: 10.3x ← 53: 9.9 ↗ 54: 9.8 → 55: 9.9 ↗ 56: 9.8 → 57: 10.2x ↑ 58: 10.3x ↗ 59: 9.9 → 60: 10.5x ↑ <hr/> Serie 100.2 Total 612.6

Hold	Skive	Jonas Ø Pedersen			
39	12				
AAS		Aalborg Skyttekreds			
2016/17		Aalborg Skyttekreds			
Prøve		1: 9.7 ↙ 2: 9.9 ↘ 3: 10.6x ↘ 4: 9.8 ↙ 5: 9.3 → 6: 10.4x ↗ 7: 10.2x ↘ 8: 9.5 → 9: 10.0 → 10: 9.9 ↗ Serie 99.3 Total 0.0	Prøve		11: 10.1 ↗ 12: 10.6x ↘ 13: 9.9 ↗ 14: 9.6 ↗ Serie 40.2 Total 0.0
60 Skud		1: 10.0 ↗ 2: 10.1 ↗ 3: 9.7 ↗ 4: 9.6 → 5: 8.8 → 6: 10.4x ↗ 7: 9.6 ↘ 8: 10.1 ← 9: 9.6 ↘ 10: 10.4x → Serie 98.3 Total 98.3	60 Skud		11: 10.0 ← 12: 10.4x ↗ 13: 10.1 ← 14: 10.6x ↗ 15: 9.4 ↗ 16: 9.8 ↗ 17: 9.5 → 18: 9.5 → 19: 9.1 → 20: 10.0 ↘ Serie 98.4 Total 196.7
60 Skud		21: 10.5x ↘ 22: 10.1 ← 23: 10.3x ↘ 24: 9.5 → 25: 10.2x → 26: 10.6x ↘ 27: 10.1 ↗ 28: 10.4x ↗ 29: 10.5x ↘ 30: 9.5 → Serie 101.7 Total 298.4	60 Skud		31: 9.8 ← 32: 8.8 → 33: 10.5x ← 34: 9.8 ↗ 35: 9.9 ← 36: 10.1 → 37: 10.5x ↗ 38: 8.6 ← 39: 10.5x ↗ 40: 10.5x ↘ Serie 99.0 Total 397.4
60 Skud		41: 9.9 ↘ 42: 10.6x ↘ 43: 10.0 ↗ 44: 9.9 → 45: 9.1 → 46: 9.9 ← 47: 10.2x ← 48: 10.0 ↘ 49: 10.2x ↘ 50: 7.9 ↗ Serie 97.7 Total 495.1	60 Skud		51: 10.1 ↗ 52: 9.1 ↗ 53: 8.1 ← 54: 10.3x ← 55: 9.2 ← 56: 10.9x ↘ 57: 10.1 ↘ 58: 10.2x ↘ 59: 9.7 ← 60: 10.3x ↗ Serie 98.0 Total 593.1