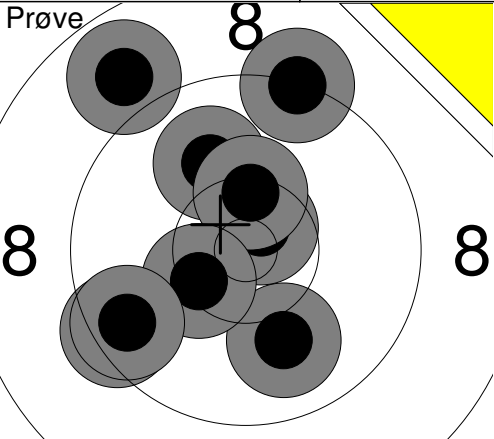
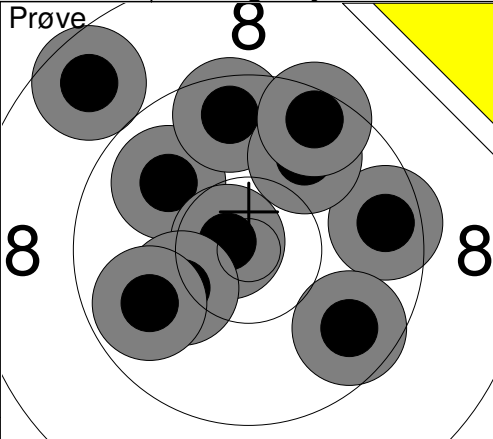
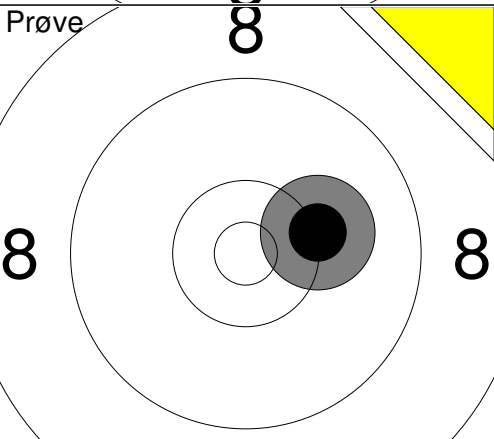
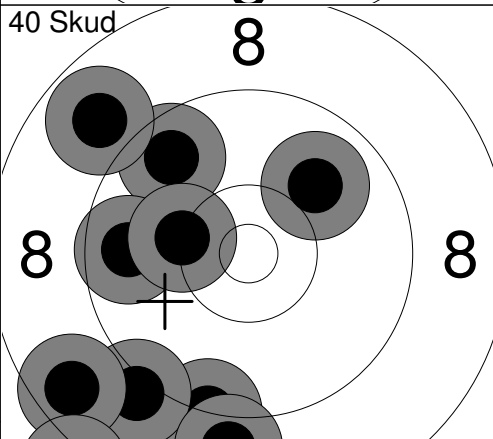
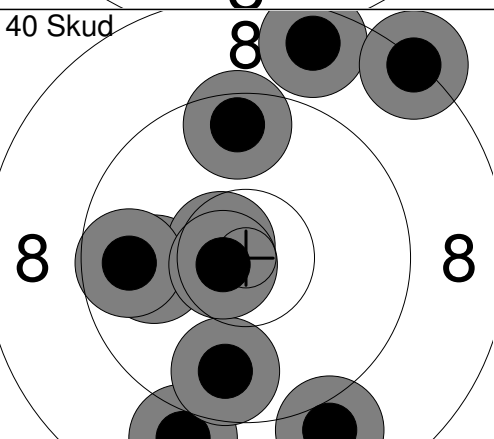
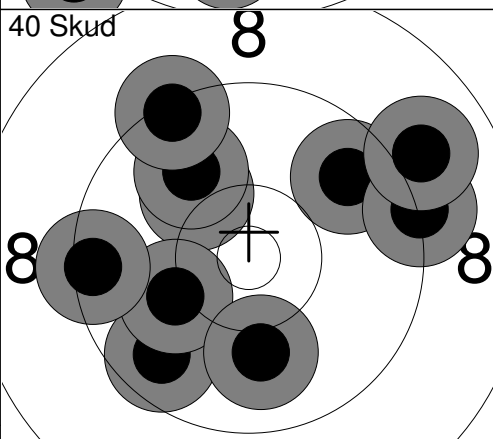
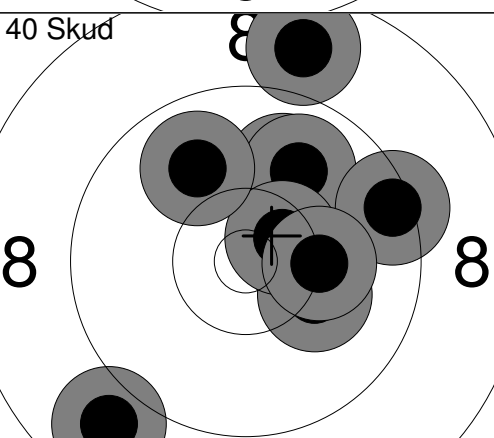

Hold	Skive	Bo Lykholt Andreassen	
1	2		
10m	Aalborg Skyttekreds	V1	P
	10 meter stævne	Aalborg Skyttekreds	
Prøve		2: 9.5 ↙ 3: 8.9 ↗ 4: 9.3 ↗ 5: 10.0 ↗ 6: 10.0 ↘ 7: 10.7x ↗ 8: 10.4x ↑ 9: 10.4x ↙ 10: 9.6 ↙ Serie 85.0 Total 0.0	Prøve  11: 9.9 ↖ 12: 9.6 ↑ 13: 10.7x ↖ 14: 9.6 → 15: 10.2 ↖ 16: 8.7 ↖ 17: 9.9 ↗ 18: 9.7 ↘ 19: 9.5 ↗ 20: 9.8 ↖ Serie 91.0 Total 0.0
Prøve		21: 10.2 → Serie 10.0 Total 0.0	40 Skud  1: 9.7 ↖ 2: 9.2 ↘ 3: 9.1 ↘ 4: 8.6 ↘ 5: 10.0 ↗ 6: 8.9 ↘ 7: 9.7 ← 8: 8.0 ↘ 9: 8.9 ↗ 10: 10.2 ← Serie 88.0 Total 88.0
40 Skud		11: 9.0 ↘ 12: 9.0 ↘ 13: 10.0 ← 14: 10.7x ↖ 15: 8.6 ↑ 16: 9.7 ↘ 17: 9.6 ↑ 18: 9.7 ← 19: 8.3 ↗ 20: 10.7x ← Serie 91.0 Total 179.0	40 Skud  21: 9.7 ↗ 22: 9.7 ↘ 23: 9.2 → 24: 10.1 ↖ 25: 9.9 ↗ 26: 10.1 ← 27: 9.4 ← 28: 9.3 ↗ 29: 9.0 ↗ 30: 10.0 ↓ Serie 93.0 Total 272.0
40 Skud		31: 8.9 ↘ 32: 10.4x → 33: 10.2 ↘ 34: 10.0 ↗ 35: 9.9 ↗ 36: 9.4 → 37: 10.5x ↗ 38: 9.9 ↗ 39: 10.2 → 40: 8.8 ↗ Serie 93.0 Total 365.0	

Hold	Skive	Erik Skovmand	
10m		Viborg Skytteforening	H R
		10 meter stævne	Aalborg Skyttekreds
Prøve		1: 10.4x ↗ 2: 9.9 ↑ 3: 9.5 ← 4: 10.3x ↑ 5: 10.6x ↘ 6: 9.9 ↗ 7: 10.6x ↘ 8: 9.8 ↙ 9: 10.2x ↖ 10: 10.3x ↘ Serie 101.5 Total 0.0	Prøve 11: 9.9 ↘ 12: 10.8x ← 13: 10.4x ↘ 14: 10.0 ↘ 15: 10.1 ↗ 16: 9.8 ↑ 17: 10.1 ↑ 18: 9.5 ← Serie 80.6 Total 0.0
60 Skud		1: 10.1 → 2: 10.8x ↘ 3: 10.5x ↘ 4: 10.2x ↙ 5: 10.7x ↗ 6: 10.4x ↑ 7: 10.9x ↘ 8: 10.7x ↗ 9: 10.7x ↖ 10: 10.6x ↑ Serie 105.6 Total 105.6	60 Skud 11: 10.4x ↗ 12: 10.6x ↖ 13: 10.3x ← 14: 10.6x ↗ 15: 10.7x ↘ 16: 10.4x ↗ 17: 10.6x ↘ 18: 10.6x ↗ 19: 10.6x ↗ 20: 9.8 → Serie 104.6 Total 210.2
60 Skud		21: 9.9 ↑ 22: 10.4x ↑ 23: 10.4x ← 24: 10.0 ← 25: 9.5 ← 26: 10.4x → 27: 10.1 ↘ 28: 10.3x ← 29: 10.4x ← 30: 10.9x ↗ Serie 102.3 Total 312.5	60 Skud 31: 10.6x ↗ 32: 10.3x → 33: 10.5x ↗ 34: 10.3x ← 35: 10.6x ↑ 36: 10.3x ↘ 37: 10.4x ↘ 38: 10.5x ↑ 39: 10.3x ↑ 40: 10.0 ↘ Serie 103.8 Total 416.3
60 Skud		41: 10.0 ↘ 42: 10.7x ↘ 43: 10.5x ← 44: 9.8 ← 45: 10.3x ↘ 46: 10.8x ← 47: 10.4x → 48: 10.5x ← 49: 10.8x ↘ 50: 10.0 ← Serie 103.8 Total 520.1	60 Skud 51: 10.4x → 52: 10.3x → 53: 10.0 ← 54: 10.0 → 55: 10.4x ↗ 56: 10.7x → 57: 9.6 ↘ 58: 10.4x ↘ 59: 10.5x ↖ 60: 9.8 ↑ Serie 102.1 Total 622.2

<p>Prøve</p>	<p>Prøve</p>
<p>1: 10.0 ↓ 2: 10.4x → 3: 8.7 → 4: 8.7 → 5: 8.9 → 6: 9.7 ← 7: 8.8 → 8: 8.8 ← 9: 9.1 → 10: 9.5 ←</p>	<p>11: 9.8 ↓ 12: 10.7x ↗</p>
Serie 92.6	Serie 20.5
Total 0.0	Total 0.0

<p>40 Skud</p>	<p>40 Skud</p>
<p>1: 8.8 ↓ 2: 10.0 ↓ 3: 9.4 ← 4: 10.0 → 5: 10.0 ↓ 6: 10.6x ↗ 7: 9.7 ↓ 8: 9.0 → 9: 10.4x ← 10: 10.6x →</p>	<p>11: 10.8x ↑ 12: 10.0 ↑ 13: 10.2x ↓ 14: 9.1 ↖ 15: 10.4x ↓ 16: 9.3 ← 17: 9.3 ↑ 18: 10.1 ↑ 19: 10.3x ↓ 20: 9.9 ↓</p>
Serie 98.5	Serie 99.4
Total 98.5	Total 197.9

<p>40 Skud</p>	<p>40 Skud</p>
<p>21: 10.5x ↖ 22: 9.1 ↑ 23: 9.3 ↖ 24: 7.8 ← 25: 10.0 ↗ 26: 9.9 ↑ 27: 10.1 → 28: 10.2x ↓ 29: 9.3 ← 30: 10.3x ↗</p>	<p>31: 9.8 ↓ 32: 9.2 ↑ 33: 9.9 → 34: 9.9 ↓ 35: 9.1 → 36: 10.0 ↗ 37: 9.6 ↓ 38: 10.5x ← 39: 9.5 ← 40: 9.2 ↓</p>
Serie 96.5	Serie 96.7
Total 294.4	Total 391.1

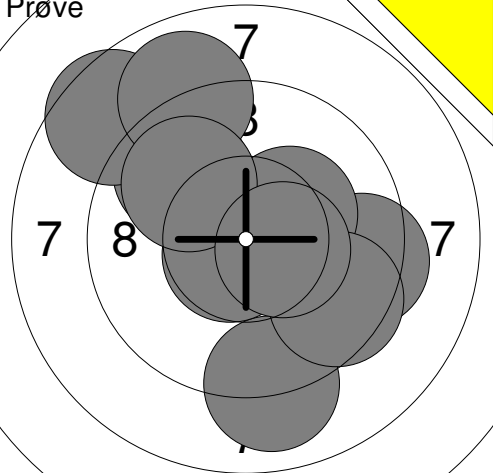
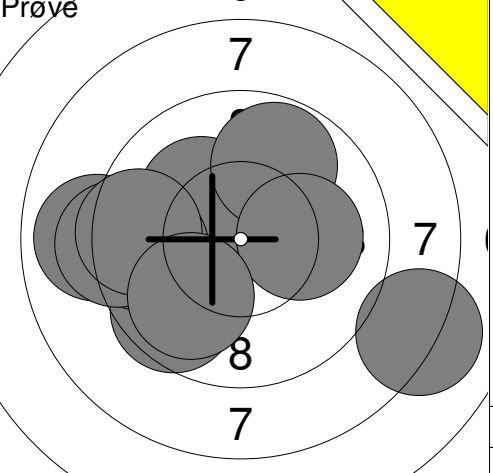
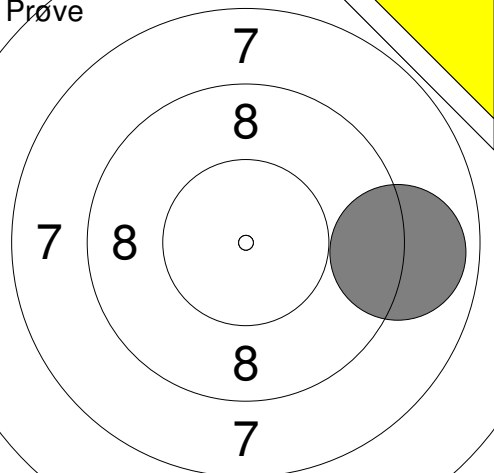
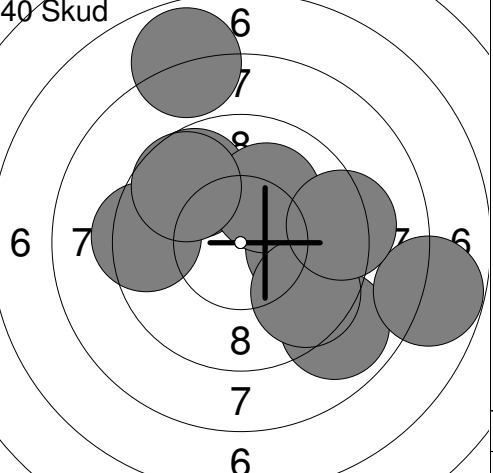
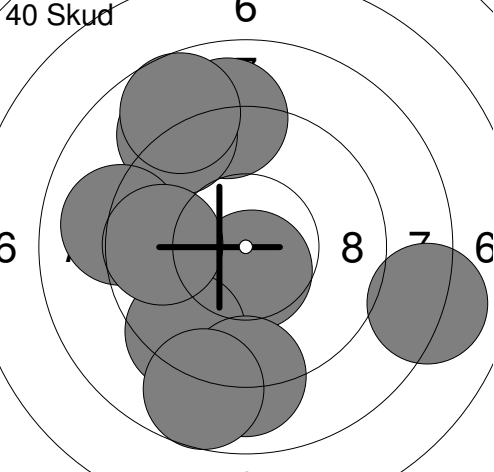
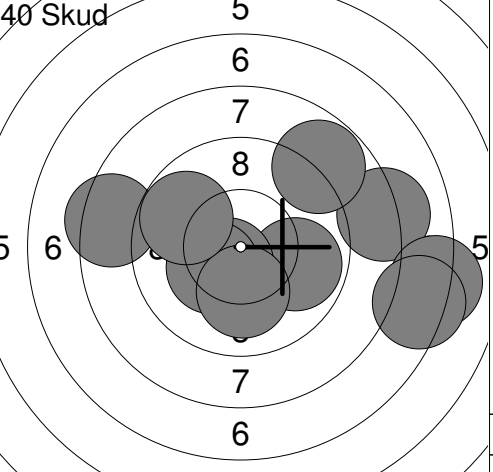
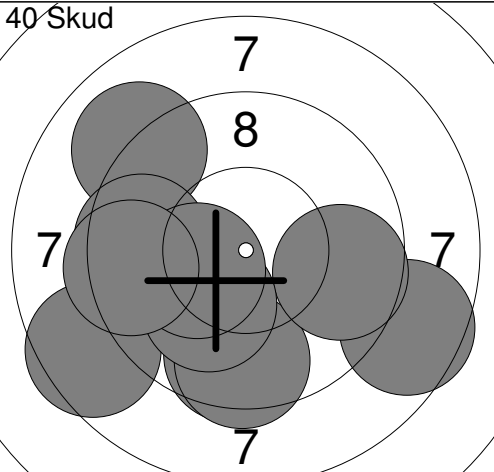
Hold	Skive	Caroline Jacobi	
1	7		
10m	Viborg Skytteforening	U15	R
	10 meter stævne	Aalborg Skyttekreds	
Prøve		1: 9.7 ↗ 2: 8.6 ↗ 3: 9.0 ↓ 4: 8.9 ↗ 5: 10.7x ↙ 6: 9.4 → 7: 10.3x ↗ 8: 9.5 ↓ 9: 9.9 ↗ 10: 10.4x → Serie 96.4 Total 0.0	Prøve  11: 8.9 ← 12: 8.1 → 13: 10.2x ↗ 14: 9.8 ↗ 15: 9.6 ↙ 16: 9.6 ← 17: 9.2 ← 18: 9.5 ← 19: 10.1 → 20: 9.9 ↙ Serie 94.9 Total 0.0
Prøve		21: 8.9 → Serie 8.9 Total 0.0	40 Skud  1: 9.4 ← 2: 9.7 ↗ 3: 10.0 → 4: 8.9 ↓ 5: 10.1 ↗ 6: 7.8 → 7: 9.7 ↗ 8: 7.9 ↗ 9: 9.6 ↓ 10: 9.3 → Serie 92.4 Total 92.4
40 Skud		11: 8.1 → 12: 9.0 ↑ 13: 9.0 ↗ 14: 9.1 ← 15: 10.6x ↓ 16: 9.4 ↙ 17: 9.0 ↓ 18: 8.7 ↓ 19: 9.7 ← 20: 8.7 ↗ Serie 91.3 Total 183.7	40 Skud  21: 8.1 → 22: 9.8 → 23: 7.1 → 24: 7.4 → 25: 8.8 ↗ 26: 10.5x ↙ 27: 10.3x ↙ 28: 8.4 ← 29: 10.1 ↓ 30: 9.8 ← Serie 90.3 Total 274.0
40 Skud		31: 8.5 ← 32: 8.6 → 33: 9.0 ↗ 34: 9.6 ↓ 35: 9.5 ↓ 36: 9.6 ← 37: 9.7 → 38: 10.1 ↓ 39: 10.3x ← 40: 9.4 ← Serie 94.3 Total 368.3	

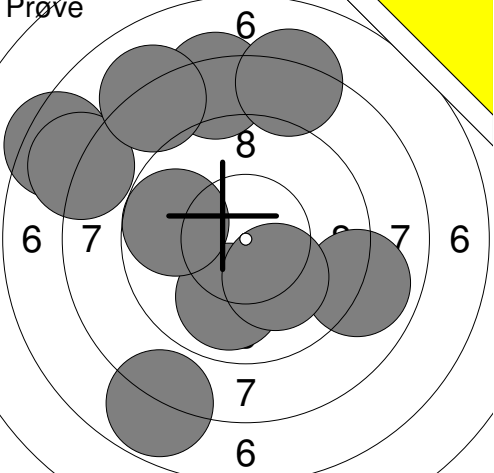
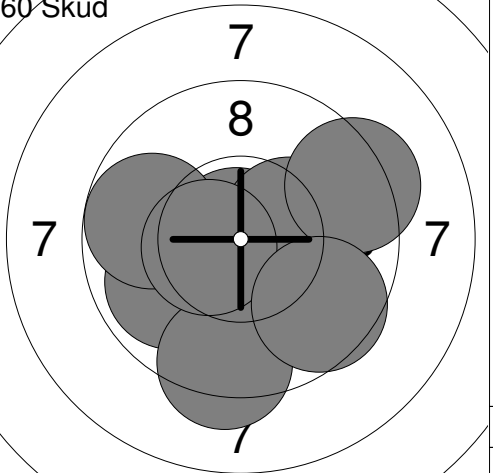
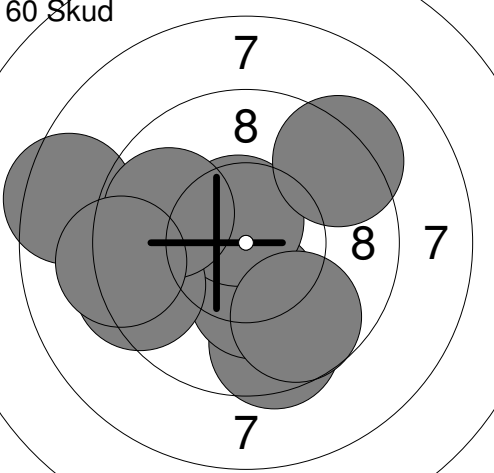
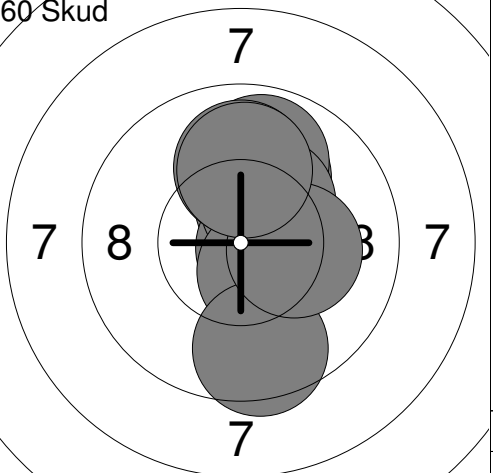
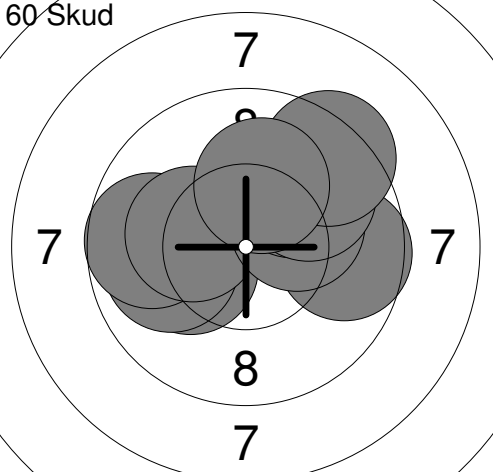
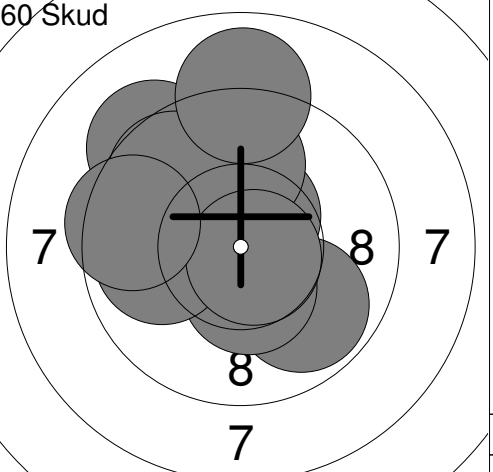
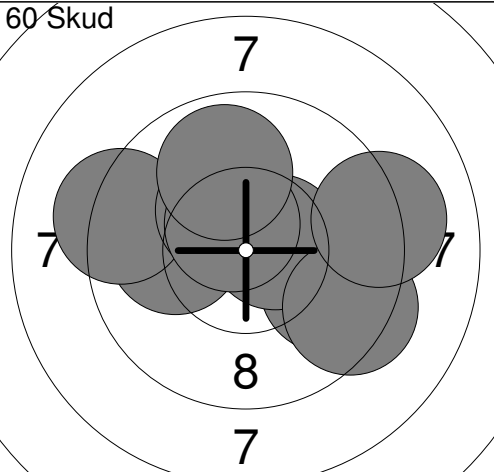
Hold	Skive	Morten Bjørn			
1	9				
10m	Viborg Skytteforening	H	R		
	10 meter stævne	Aalborg Skyttekreds			
Prøve		1: 8.3 ↑ 2: 9.9 ↓ 3: 7.8 ↓ 4: 8.2 ↑ 5: 9.7 ← 6: 7.4 ↖ 7: 7.9 ↖ 8: 8.1 ↗ 9: 8.9 → 10: 10.1 ↓ Serie 86.3 Total 0.0	60 Skud		1: 9.9 ← 2: 10.7x ↓ 3: 10.9x ↗ 4: 10.3x ↓ 5: 9.3 ↓ 6: 10.3x → 7: 9.8 ← 8: 9.3 → 9: 10.5x ← 10: 9.6 ↓ Serie 100.6 Total 100.6
60 Skud		11: 9.7 ← 12: 9.5 ↓ 13: 10.2x ↓ 14: 10.6x ↑ 15: 9.7 ↓ 16: 9.3 ↗ 17: 9.4 ← 18: 8.5 ← 19: 9.8 ← 20: 9.2 ← Serie 95.9 Total 196.5	60 Skud		21: 10.4x ↑ 22: 10.6x → 23: 10.0 ↑ 24: 9.9 ↑ 25: 10.3x ↗ 26: 10.5x ↓ 27: 9.5 ↓ 28: 10.2x → 29: 10.0 ↑ 30: 10.0 ↑ Serie 101.4 Total 297.9
60 Skud		31: 10.2x ← 32: 9.9 ← 33: 9.7 ← 34: 10.2x ← 35: 9.7 → 36: 10.2x → 37: 10.0 ↗ 38: 9.8 ↗ 39: 9.4 ↗ 40: 10.1 ↑ Serie 99.2 Total 397.1	60 Skud		41: 9.8 ↓ 42: 10.5x ↑ 43: 9.9 ↑ 44: 10.4x ↓ 45: 9.9 ← 46: 9.2 ↗ 47: 9.7 ↗ 48: 10.7x ↓ 49: 8.9 ↑ 50: 9.5 ← Serie 98.5 Total 495.6
60 Skud		51: 10.5x ↑ 52: 10.0 ← 53: 9.8 → 54: 10.5x → 55: 9.2 ← 56: 9.4 ↓ 57: 10.3x ↗ 58: 9.1 → 59: 10.6x ↗ 60: 9.9 ↑ Serie 99.3 Total 594.9			

<p>Prøve</p>	<p>2: 6.8 ↓ 3: 8.0 ↓ 4: 9.5 → 5: 8.2 → 6: 9.3 ↓ 7: 9.1 ↓ 8: 9.2 ↗ 9: 9.1 ↑ 10: 9.5 ↗</p> <p>Serie 78.7 Total 0.0</p>	<p>Prøve</p>	<p>11: 10.5x ↗ 12: 9.0 ↖ 13: 10.3x ← 14: 8.9 ← 15: 10.6x ↗ 16: 10.1 → 17: 10.6x ↖ 18: 9.9 ← 19: 10.0 ↓ 20: 10.7x →</p> <p>Serie 100.6 Total 0.0</p>
--------------	----------------------------------------------------------------------------------------------------------------------------------------------------------	--------------	---------------------------------------------------------------------------------------------------------------------------------------------------------------------------------------------

<p>Prøve</p>	<p>21: 10.0 ↓</p> <p>Serie 10.0 Total 0.0</p>	<p>40 Skud</p>	<p>1: 9.7 → 2: 9.9 ← 3: 10.4x ← 4: 10.1 ↑ 5: 10.5x ← 6: 10.3x ↓ 7: 10.3x ← 8: 10.3x ↓ 9: 8.9 ↗ 10: 9.7 ↑</p> <p>Serie 100.1 Total 100.1</p>
--------------	---------------------------------------------------	----------------	-------------------------------------------------------------------------------------------------------------------------------------------------------------------------------------

<p>40 Skud</p>	<p>11: 10.0 ↖ 12: 10.6x ↖ 13: 10.1 ↑ 14: 10.4x ← 15: 10.7x ↓ 16: 10.1 ← 17: 9.7 → 18: 10.2x → 19: 9.5 → 20: 10.6x →</p> <p>Serie 101.9 Total 202.0</p>	<p>40 Skud</p>	<p>21: 8.1 ↓ 22: 10.5x → 23: 10.3x → 24: 10.6x ← 25: 10.6x → 26: 10.4x ↗ 27: 9.7 ← 28: 10.2x ↗ 29: 8.8 ↖ 30: 10.2x ↖</p> <p>Serie 99.4 Total 301.4</p>
----------------	------------------------------------------------------------------------------------------------------------------------------------------------------------------------------------------------	----------------	------------------------------------------------------------------------------------------------------------------------------------------------------------------------------------------------

<p>40 Skud</p>	<p>31: 9.9 ← 32: 10.4x ↑ 33: 10.2x → 34: 8.4 → 35: 9.9 ↗ 36: 10.1 ↗ 37: 9.2 ← 38: 10.4x ↑ 39: 10.6x ← 40: 10.3x →</p> <p>Serie 99.4 Total 400.8</p>		
----------------	---------------------------------------------------------------------------------------------------------------------------------------------------------------------------------------------	--	--

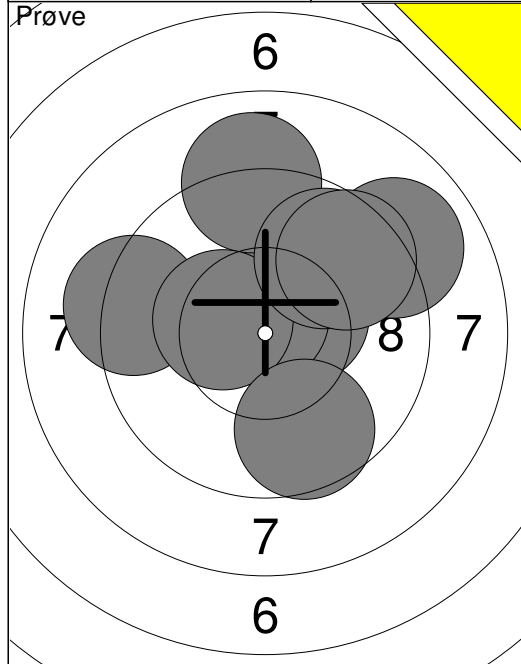

2:	10.5x ↗
3:	10.7x ↗
4:	9.0 ↗
5:	9.2 ←
6:	9.0 ↑
7:	10.4x ↙
8:	9.7 ↗
9:	9.6 ↓
10:	9.6 ↗
<b>Serie 87.7</b>	
<b>Total 0.0</b>	

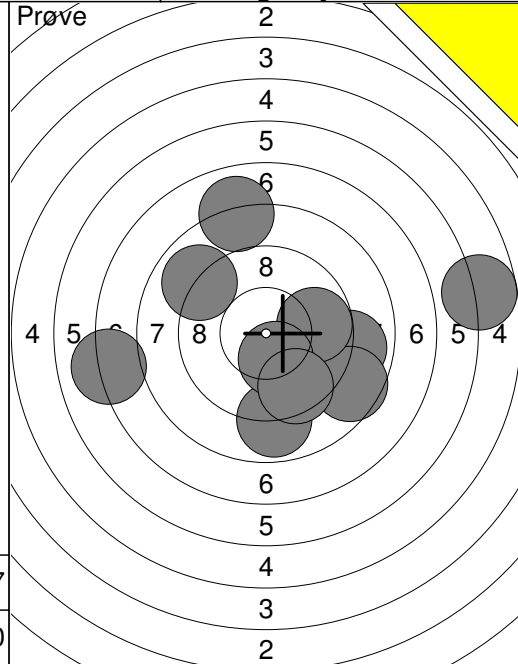

11:	8.0	↗
12:	5.8	→
13:	8.9	↓
14:	8.9	→
15:	8.6	↘
16:	9.8	→
17:	8.9	↗
18:	10.3x	↓
19:	9.5	↓
20:	7.1	←
<b>Serie 85.8</b>		
<b>Total 0.0</b>		

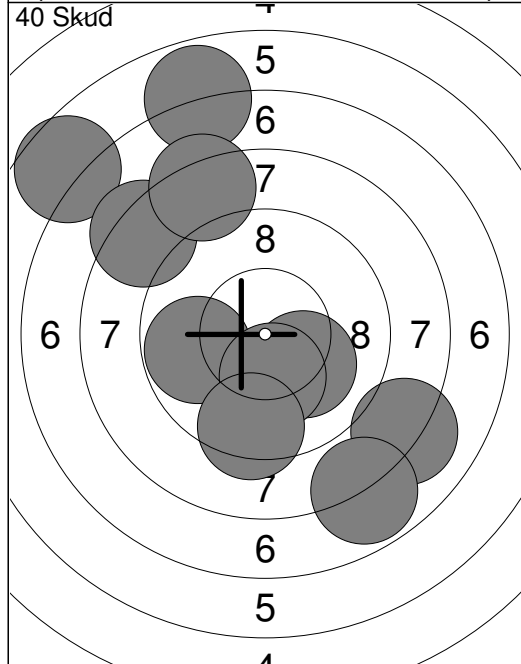

1:	6.6	↗
2:	6.8	↑
3:	8.1	↘
4:	9.8	←
5:	7.8	↘
6:	8.3	↗
7:	10.1	↘
8:	10.2x	↓
9:	9.4	↓
10:	8.3	↑
<b>Serie 85.4</b>		
<b>Total 85.4</b>		

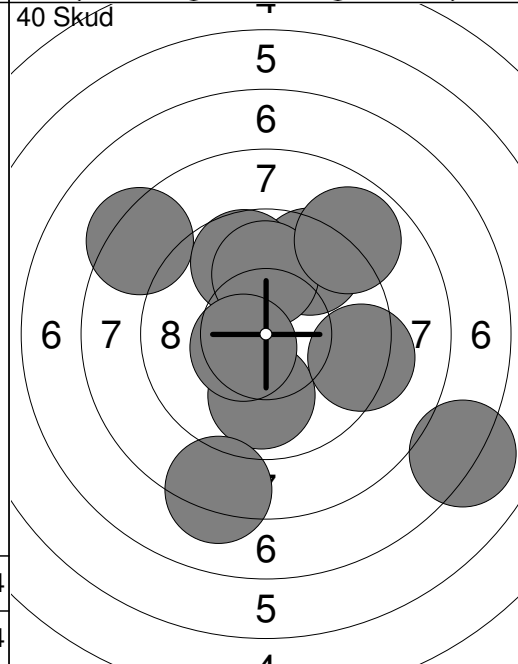

11:	8.3	↖
12:	9.5	↗
13:	9.7	↑
14:	9.9	↓
15:	8.2	↓
16:	7.1	↘
17:	9.3	→
18:	9.9	↑
19:	10.5x	↙
20:	8.9	↗
<b>Serie 91.3</b>		
<b>Total 176.7</b>		

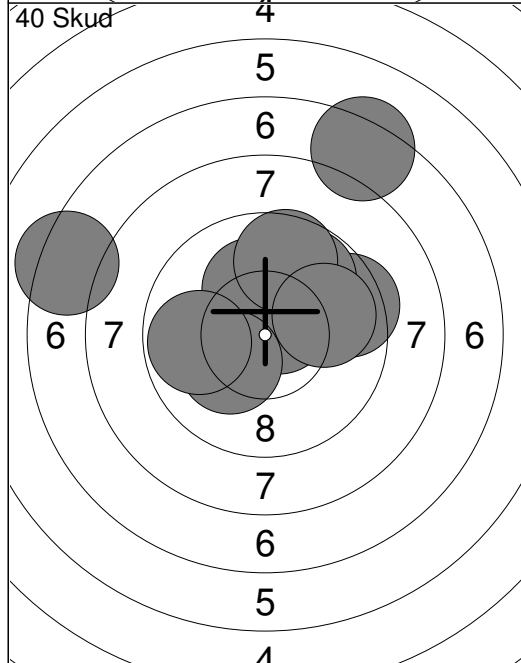

21:	10.6x	↗
22:	9.4	→
23:	7.3	←
24:	9.8	↗
25:	7.3	↗
26:	10.1	↑
27:	10.2x	↙
28:	9.8	←
29:	9.6	↑
30:	9.9	→
<b>Serie 94.0</b>		
<b>Total 270.7</b>		

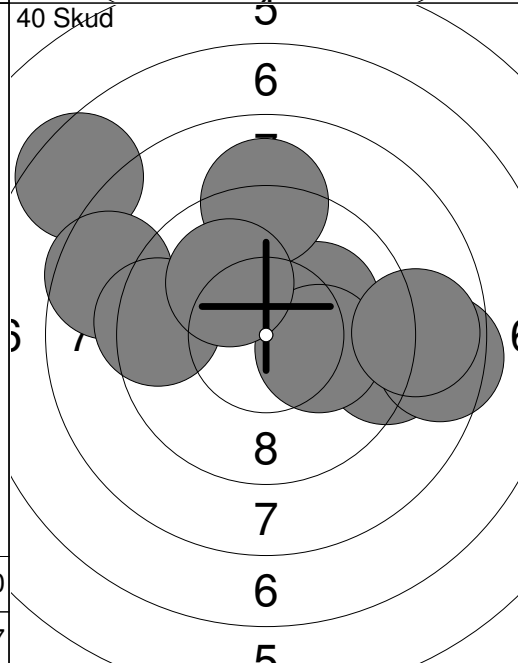

31:	7.5	↖
32:	10.1	↗
33:	8.6	←
34:	9.4	←
35:	9.2	→
36:	10.2x	→
37:	9.1	↑
38:	8.5	→
39:	8.8	→
40:	10.1	↖
<b>Serie 91.5</b>		
<b>Total 362.2</b>		

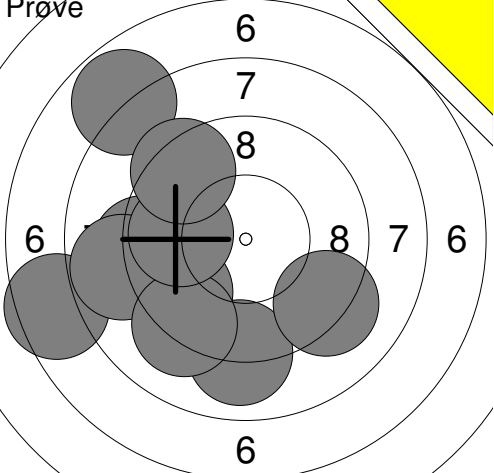
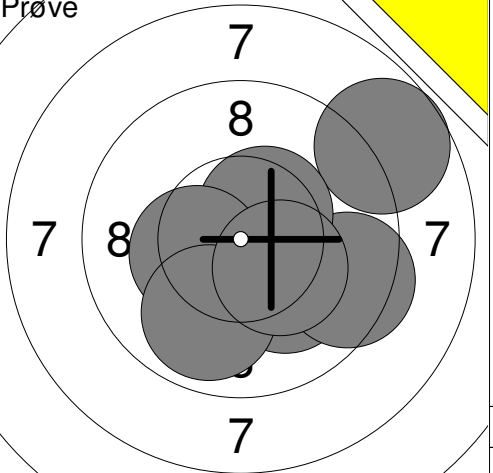
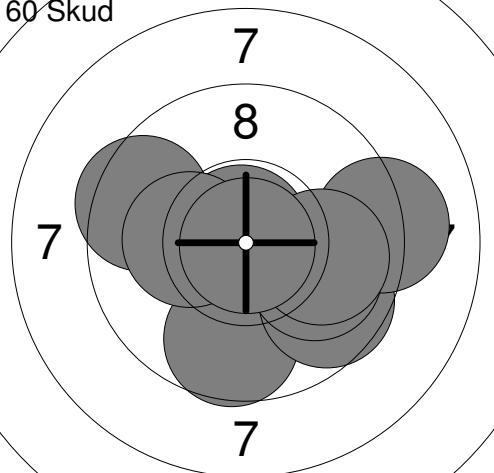
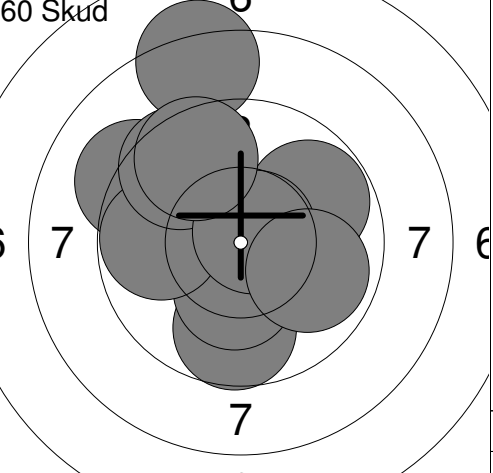
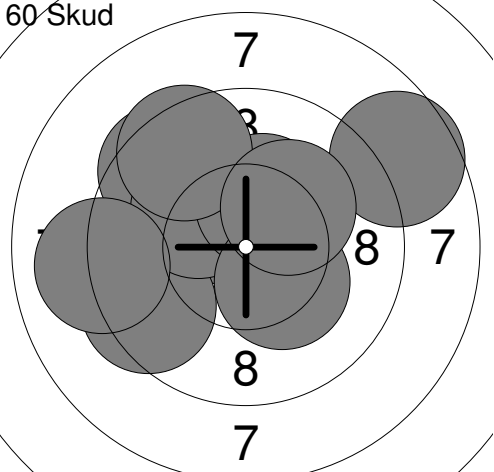
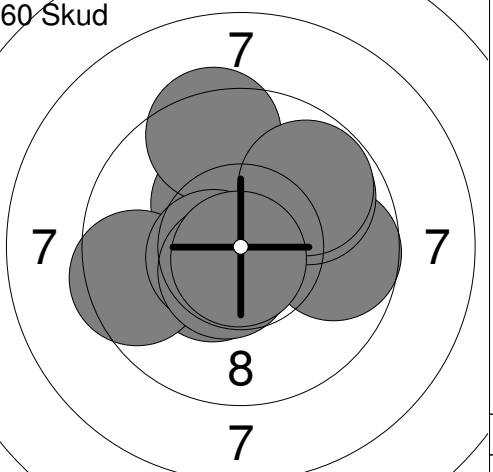
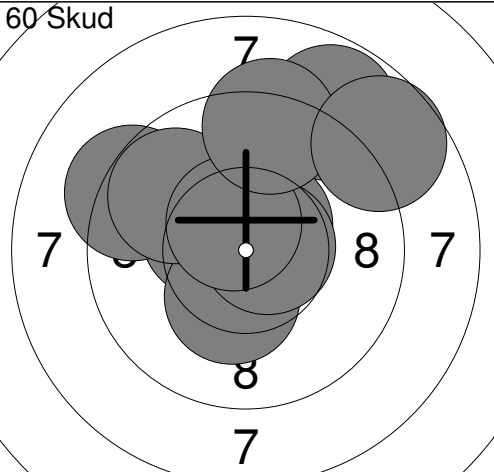
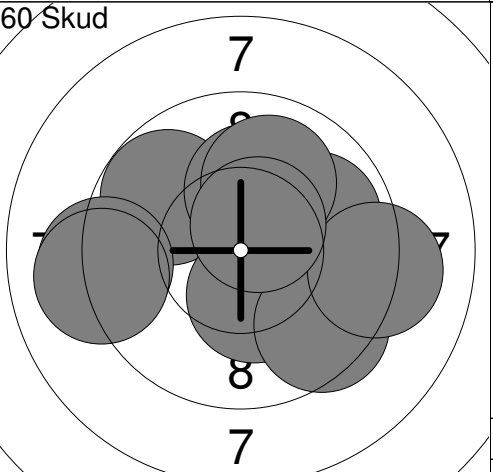
Hold	Skive	Jacob Laursen			
1	12				
10m	Viborg Skytteforening	HJ	R		
	10 meter stævne	Aalborg Skyttekreds			
Prøve		1: 9.2 ← 2: 9.0 ↓ 3: 9.2 ↘ 4: 9.5 ↙ 5: 7.5 ← 6: 8.8 ← 7: 9.2 ↙ 8: 7.8 ↗ 9: 9.8 ← 10: 9.4 ↗ Serie 89.4 Total 0.0	Prøve		11: 8.7 ↗ 12: 10.1 ↘ 13: 9.4 → 14: 10.5x ↗ 15: 10.3x ← 16: 9.9 ↓ 17: 10.3x ↘ Serie 69.2 Total 0.0
60 Skud		1: 9.7 ↓ 2: 9.6 ↘ 3: 9.1 → 4: 10.0 ↘ 5: 10.7x ↖ 6: 9.5 ↖ 7: 10.8x ↗ 8: 9.9 → 9: 10.2x ← 10: 10.9x ↓ Serie 100.4 Total 100.4	60 Skud		11: 8.2 ↑ 12: 9.8 ↗ 13: 9.7 ↓ 14: 10.3x ↓ 15: 9.2 ↖ 16: 9.8 ← 17: 9.6 ↗ 18: 10.7x ↗ 19: 9.6 ↗ 20: 9.9 → Serie 96.8 Total 197.2
60 Skud		21: 9.5 ↗ 22: 10.5x ↗ 23: 9.4 ← 24: 10.2x ↖ 25: 10.3x ↗ 26: 9.0 ← 27: 9.5 ↗ 28: 8.6 ↗ 29: 10.3x ↘ 30: 10.2x ↗ Serie 97.5 Total 294.7	60 Skud		31: 10.3x ↖ 32: 10.4x ↙ 33: 9.4 ↑ 34: 9.7 → 35: 9.5 ← 36: 10.6x ← 37: 10.6x ↙ 38: 9.8 ↗ 39: 9.8 ↗ 40: 10.8x ↓ Serie 100.9 Total 395.6
60 Skud		41: 8.8 ↗ 42: 10.5x ↗ 43: 10.4x ↖ 44: 10.3x ↓ 45: 9.3 ↖ 46: 9.8 ↖ 47: 10.7x → 48: 10.6x ↗ 49: 9.3 ↑ 50: 8.7 ↗ Serie 98.4 Total 494.0	60 Skud		51: 9.8 ↖ 52: 10.1 ↑ 53: 9.2 ← 54: 9.9 ↗ 55: 10.3x ↓ 56: 10.0 ↑ 57: 9.5 ↘ 58: 9.2 → 59: 9.1 ← 60: 10.5x ↗ Serie 97.6 Total 591.6

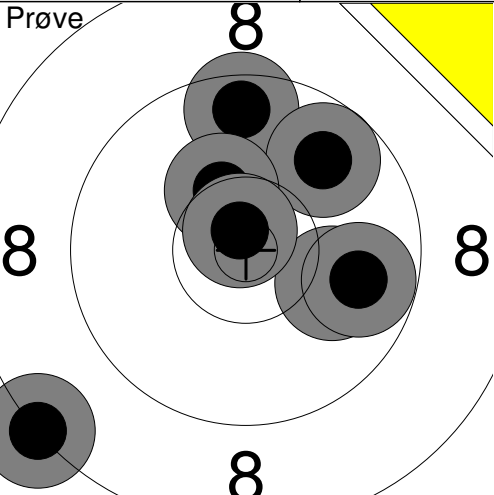
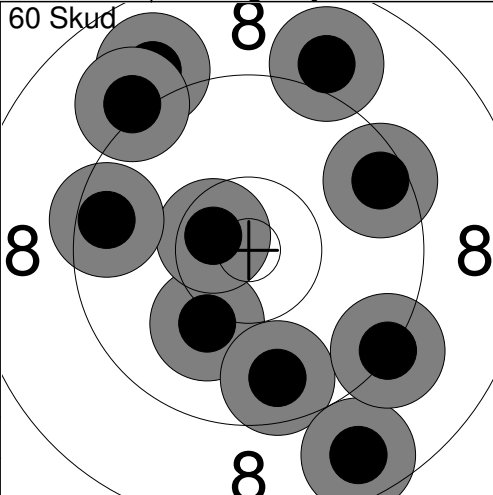
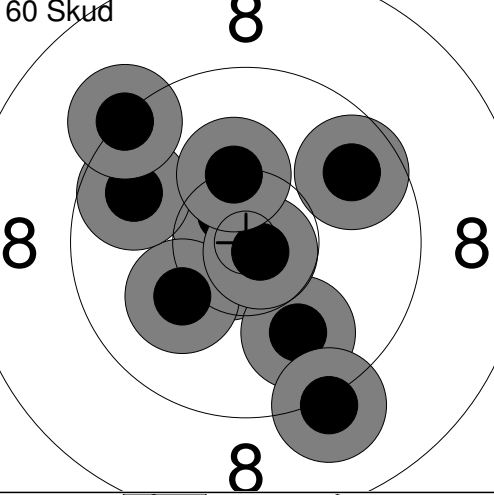
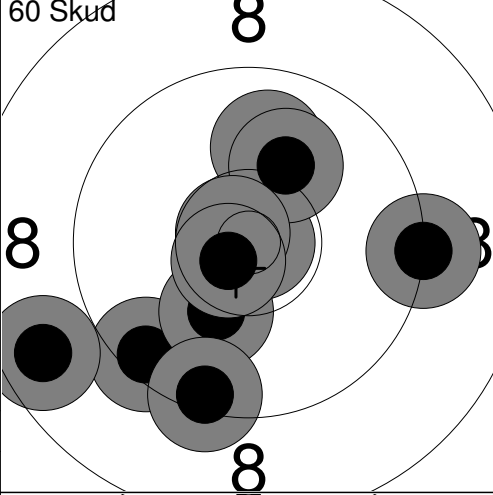
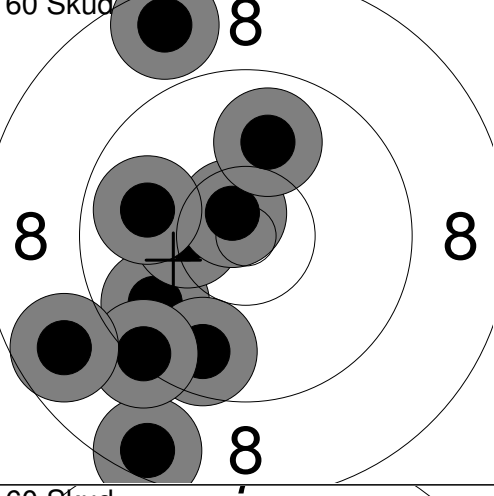
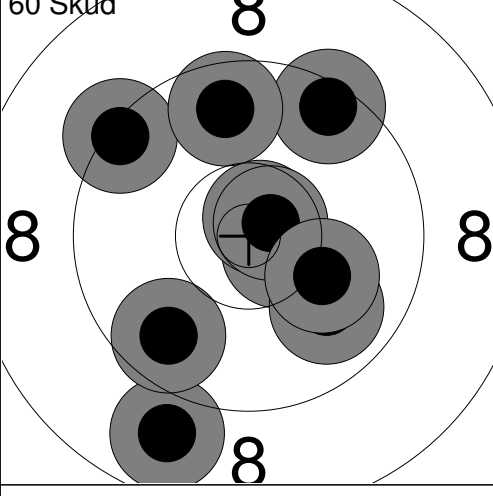
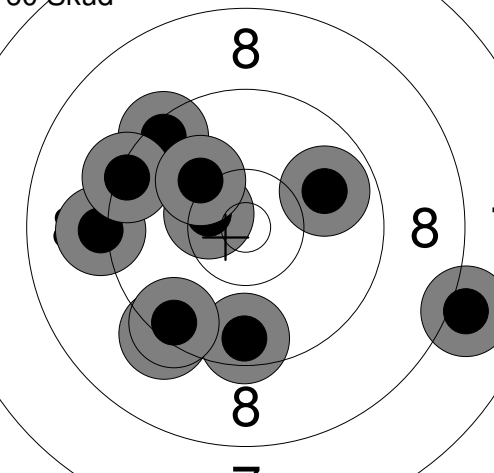

	10 meter stævne	Aalborg Skyttekreds
Prøve 	1: 9.6 ↑ 2: 10.0 → 3: 9.8 ↗ 4: 10.3 ↑ 5: 10.7x ↑ 6: 8.2 ↙ 7: 9.8 → Serie 65.0 Total 0.0	60 Skud  1: 8.9 ↖ 2: 9.5 ↗ 3: 10.1 ↘ 4: 10.6x ↖ 5: 9.7 ↘ 6: 8.7 ↘ 7: 9.3 ↘ 8: 9.0 ↑ 9: 9.5 ← 10: 9.1 ↗ Serie 90.0 Total 90.0
60 Skud 	11: 9.7 ↗ 12: 10.7x ↘ 13: 10.6x ↗ 14: 9.9 ↘ 15: 10.1 ↘ 16: 9.7 ↖ 17: 10.8x ↘ 18: 9.2 ↘ 19: 9.3 ↗ 20: 10.3 ↑ Serie 95.0 Total 185.0	60 Skud  21: 10.9x → 22: 9.2 → 23: 9.5 ↘ 24: 10.0 ↑ 25: 10.1 ↗ 26: 10.8x ↖ 27: 10.2 ↘ 28: 10.7x ↘ 29: 9.4 ↘ 30: 8.7 ↖ Serie 95.0 Total 280.0
60 Skud 	31: 9.8 ↙ 32: 8.5 ↘ 33: 8.6 ↗ 34: 10.3 ← 35: 10.7x ↗ 36: 9.7 ↘ 37: 9.3 ↘ 38: 9.9 ← 39: 8.7 ↙ 40: 10.0 ↑ Serie 90.0 Total 370.0	60 Skud  41: 10.6x → 42: 10.7x ↗ 43: 8.9 ↘ 44: 9.7 ↘ 45: 9.4 ↖ 46: 9.9 ↘ 47: 10.7x ↗ 48: 9.5 ↗ 49: 10.1 → 50: 9.7 ↑ Serie 93.0 Total 463.0
60 Skud 	51: 9.4 ↗ 52: 8.0 → 53: 9.9 ↗ 54: 9.6 ↘ 55: 10.5x ↖ 56: 9.2 ← 57: 9.4 ↖ 58: 10.1 ↗ 59: 9.3 ↘ 60: 9.5 ↘ Serie 91.0 Total 554.0	

10 meter stævne		Aalborg Skyttekreds	
Prøve 	1: 9.7 ↗ 2: 10.4x → 3: 10.4x → 4: 10.7x ↘ 5: 10.1 ↗ 6: 9.8 ↘ 7: 10.0 ↘ 8: 10.0 ↗ 9: 9.8 ← 10: 10.6x ↙ Serie 101.5 Total 0.0	Prøve 	11: 9.9 ↙ 12: 10.6x → 13: 9.9 → 14: 10.7x ↘ 15: 10.3x ↙ 16: 10.4x ↗ 17: 10.2x ↘ 18: 8.8 ↖ 19: 10.1 ↑ Serie 90.9 Total 0.0
60 Skud 	1: 9.0 ← 2: 10.7x ↑ 3: 10.7x ↘ 4: 9.9 ← 5: 9.6 ↗ 6: 10.5x ← 7: 10.6x ↘ 8: 9.8 ↘ 9: 10.1 ↘ 10: 10.7x ↘ Serie 101.6 Total 101.6	60 Skud 	11: 8.9 ↗ 12: 9.8 ↘ 13: 9.9 ↘ 14: 10.8x ↘ 15: 10.4x ↑ 16: 8.5 → 17: 10.2x ↑ 18: 10.2x → 19: 10.7x ↘ 20: 8.8 ↙ Serie 98.2 Total 199.8
60 Skud 	21: 10.6x ↑ 22: 10.6x ↖ 23: 10.9x ↘ 24: 10.3x ↑ 25: 9.7 ↗ 26: 9.7 ↗ 27: 10.6x → 28: 9.7 ↖ 29: 9.9 ← 30: 9.7 ↑ Serie 101.7 Total 301.5	60 Skud 	31: 10.2x ↘ 32: 10.2x ↗ 33: 9.3 → 34: 10.4x ↘ 35: 9.4 → 36: 9.6 ↙ 37: 10.4x ↑ 38: 10.6x → 39: 10.5x ← 40: 10.3x → Serie 100.9 Total 402.4
60 Skud 	41: 10.2x ↑ 42: 10.0 ↙ 43: 10.5x ↗ 44: 10.0 → 45: 10.5x ↗ 46: 10.6x ↑ 47: 9.7 ↘ 48: 10.7x ↗ 49: 10.7x ↘ 50: 10.0 → Serie 102.9 Total 505.3	60 Skud 	51: 10.3x ↘ 52: 10.0 → 53: 10.3x ↘ 54: 9.3 → 55: 10.2x ↗ 56: 10.5x ← 57: 10.4x → 58: 10.2x ← 59: 10.3x ↘ 60: 9.1 ↗ Serie 100.6 Total 605.9

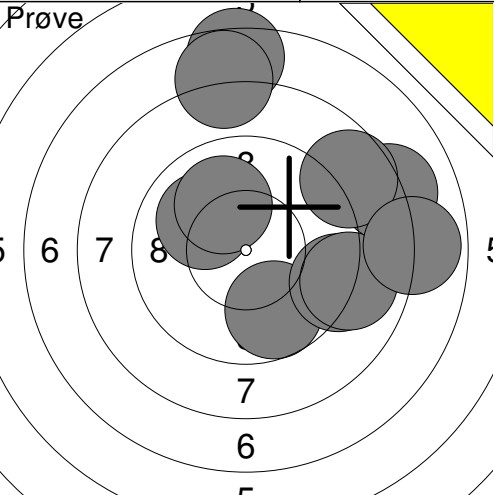
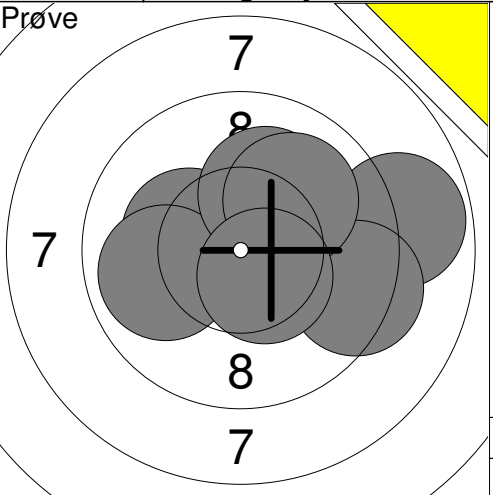
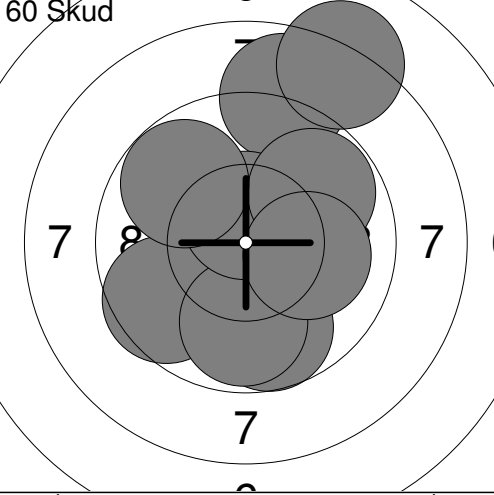
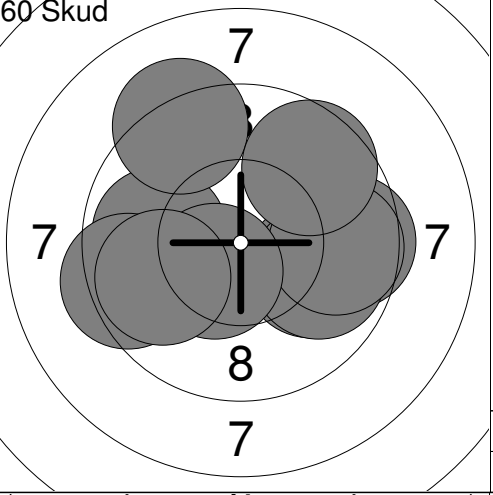
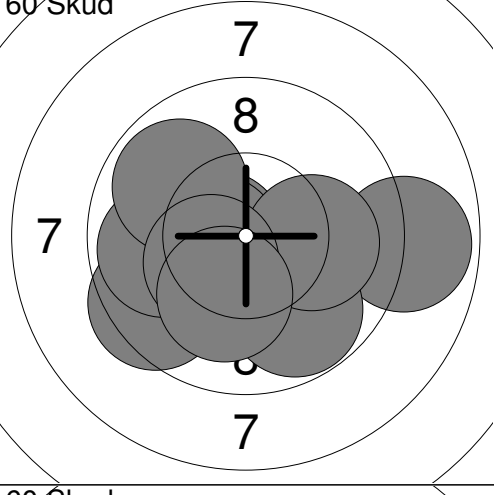
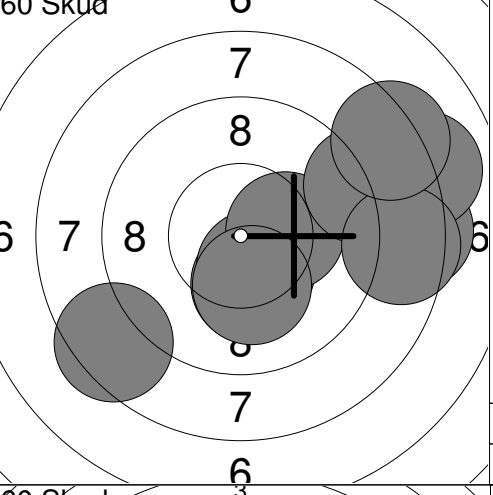
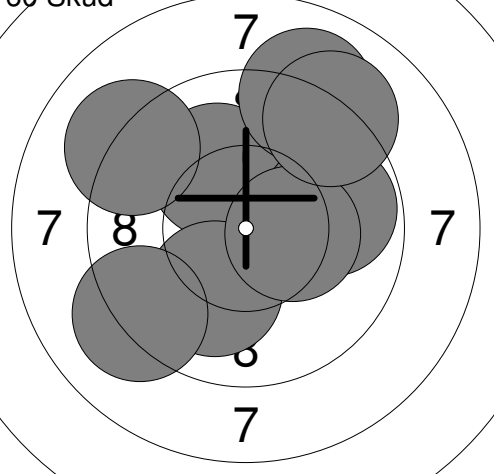
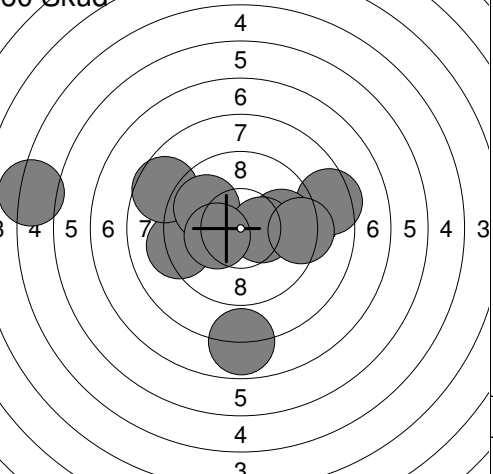
Hold	Skive	Nicki Fabricius	
2	10		
10m	Aalborg Skyttekreds	H	R
	10 meter stævne	Aalborg Skyttekreds	
Prøve		1: 7.4 ↑ 2: 7.8 ↑ 3: 10.0 ↗ 4: 9.7 ↓ 5: 9.1 → 6: 9.0 → 7: 8.1 → 8: 8.7 ↗ 9: 10.0 ↑ 10: 7.9 → Serie 87.7 Total 0.0	Prøve  11: 8.8 → 12: 10.2x ← 13: 9.4 → 14: 9.9 ← 15: 10.1 ↑ 16: 10.0 ↗ 17: 10.5x ↓ Serie 68.9 Total 0.0
60 Skud		1: 9.6 ← 2: 9.7 ↓ 3: 8.9 ↑ 4: 9.8 ↓ 5: 10.2x ↗ 6: 8.1 ↑ 7: 10.6x ↑ 8: 9.8 ↗ 9: 9.8 ↗ 10: 10.1 → Serie 96.6 Total 96.6	60 Skud  11: 10.0 → 12: 9.5 → 13: 9.9 ← 14: 9.9 → 15: 9.7 → 16: 9.2 ↑ 17: 10.4x ↓ 18: 9.6 ↗ 19: 9.4 ← 20: 9.8 ← Serie 97.4 Total 194.0
60 Skud		21: 10.6x ← 22: 9.5 ← 23: 10.5x ← 24: 8.9 → 25: 9.8 ↓ 26: 9.9 ← 27: 9.9 ↗ 28: 10.1 → 29: 10.4x ← 30: 10.1 ↓ Serie 99.7 Total 293.7	60 Skud  31: 10.2x ↓ 32: 10.4x ↓ 33: 10.3x → 34: 8.3 → 35: 8.9 → 36: 8.4 ← 37: 8.0 → 38: 10.2x ↓ 39: 8.5 → 40: 8.3 ↗ Serie 91.5 Total 385.2
60 Skud		41: 10.3x ↗ 42: 10.1 ↑ 43: 10.1 ↓ 44: 9.7 ↗ 45: 9.2 ← 46: 9.1 ↗ 47: 9.8 → 48: 9.0 ↑ 49: 10.3x → 50: 9.1 ↗ Serie 96.7 Total 481.9	60 Skud  51: 7.9 ↓ 52: 5.2 ← 53: 9.2 ← 54: 8.6 ← 55: 8.4 → 56: 9.8 → 57: 9.9 ← 58: 10.4x → 59: 10.3x ← 60: 9.3 → Serie 89.0 Total 570.9

Prøve 	1: 10.7x ↗ 2: 9.7 ← 3: 9.0 ↓ 4: 10.5x ← 5: 9.8 ← 6: 9.5 ← 7: 10.4x ↓ 8: 9.8 ↓ 9: 10.2x ← 10: 9.9 ← Serie 99.5 Total 0.0	Prøve 	11: 10.6x ↗ 12: 10.1 ↓ 13: 10.2x ← 14: 9.8 ↗ 15: 10.3x ↓ Serie 51.0 Total 0.0
-----------	----------------------------------------------------------------------------------------------------------------------------------------------------------	-----------	-------------------------------------------------------------------------------------------------

60 Skud 	1: 10.6x ← 2: 10.7x ↗ 3: 10.0 ↓ 4: 10.9x ↗ 5: 9.2 ← 6: 10.1 → 7: 10.3x ↑ 8: 10.3x ↓ 9: 10.5x ↙ 10: 10.6x ← Serie 103.2 Total 103.2	60 Skud 	11: 10.2x ← 12: 10.5x ↗ 13: 9.7 ← 14: 10.5x ↓ 15: 9.6 ↙ 16: 10.3x ↙ 17: 10.8x ↓ 18: 9.9 ← 19: 10.8x ↑ 20: 10.7x ↓ Serie 103.0 Total 206.2
-------------	---------------------------------------------------------------------------------------------------------------------------------------------------------------------	-------------	----------------------------------------------------------------------------------------------------------------------------------------------------------------------------

60 Skud 	21: 10.7x ↗ 22: 10.6x ↙ 23: 10.3x ↗ 24: 10.7x ↗ 25: 10.1 ↙ 26: 9.7 ↗ 27: 10.5x ← 28: 10.2x ↗ 29: 10.5x → 30: 10.7x ↗ Serie 104.0 Total 310.2	60 Skud 	31: 10.3x ↓ 32: 9.9 ↓ 33: 10.7x ↓ 34: 10.3x ↑ 35: 10.1 → 36: 10.2x ↗ 37: 10.7x → 38: 10.6x ↙ 39: 10.2x ↑ 40: 10.3x ↑ Serie 103.3 Total 413.5
-------------	-------------------------------------------------------------------------------------------------------------------------------------------------------------------------------	-------------	-------------------------------------------------------------------------------------------------------------------------------------------------------------------------------

60 Skud 	41: 9.9 ← 42: 10.5x ↓ 43: 10.6x ↗ 44: 10.5x ↑ 45: 10.5x ← 46: 10.3x ↓ 47: 10.0 ← 48: 10.0 → 49: 9.7 ← 50: 9.3 ← Serie 101.3 Total 514.8	60 Skud 	51: 10.5x ↓ 52: 10.2x → 53: 10.7x ↙ 54: 10.3x ↙ 55: 10.6x → 56: 9.5 ↑ 57: 10.2x ↗ 58: 10.7x ↗ 59: 9.9 → 60: 10.6x ↓ Serie 103.2 Total 618.0
-------------	--------------------------------------------------------------------------------------------------------------------------------------------------------------------------	-------------	------------------------------------------------------------------------------------------------------------------------------------------------------------------------------

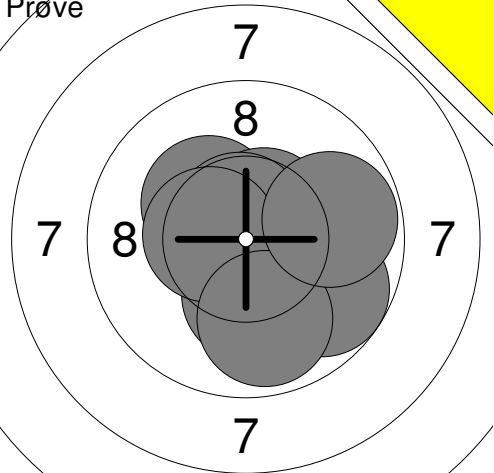
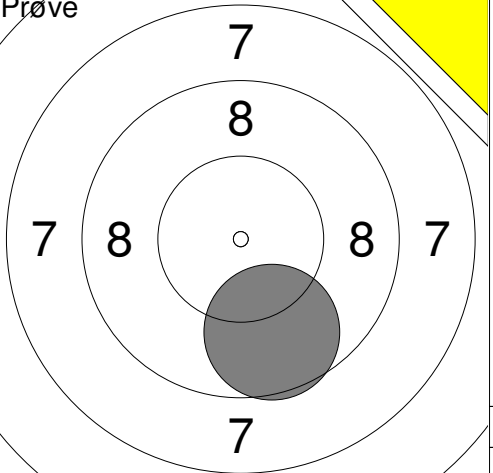
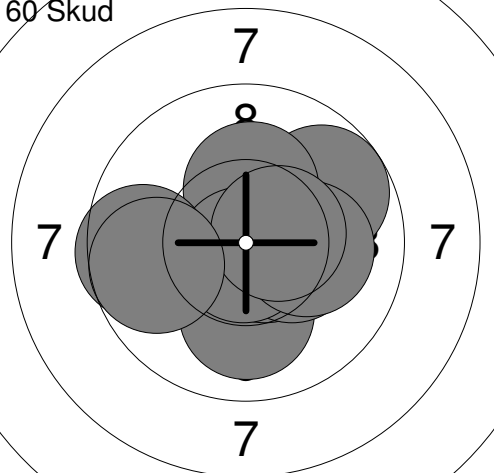
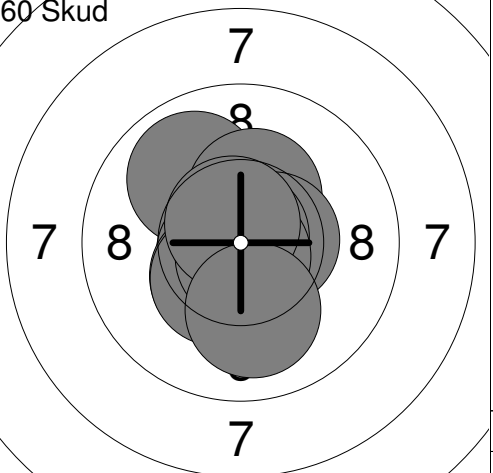
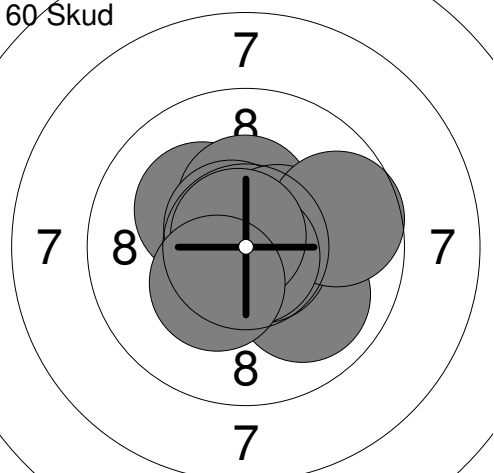
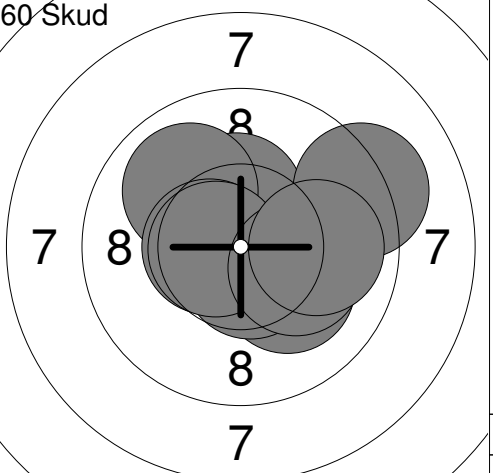
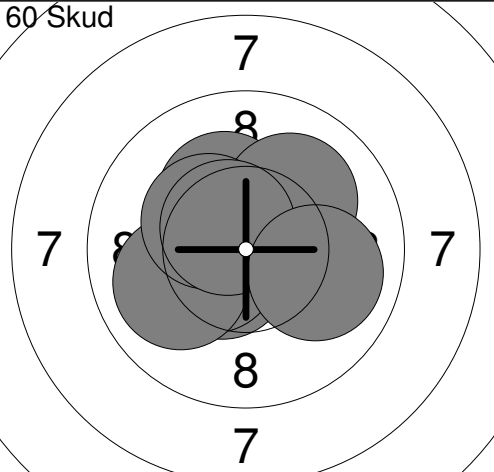
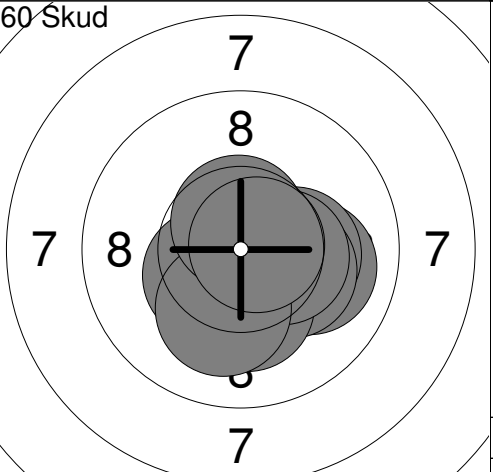
10 meter stævne		Aalborg Skyttekreds	
Prøve 	1: 10.3x ↗ 2: 10.6x ↗ 3: 10.6x ↘ 4: 10.0 ↘ 5: 10.7x ↗ 6: 10.2x ↘ 7: 9.8 ↘ 8: 10.5x ← 9: 9.9 ↘ 10: 9.8 → <hr/> Serie 102.4 Total 0.0	Prøve 	11: 9.7 ↓ <hr/> Serie 9.7 Total 0.0
60 Skud 	1: 10.0 ↓ 2: 10.7x ↘ 3: 9.8 ↗ 4: 10.3x → 5: 10.3x ↑ 6: 10.8x ↓ 7: 10.1 → 8: 9.6 ← 9: 10.5x → 10: 9.7 ← <hr/> Serie 101.8 Total 101.8	60 Skud 	11: 9.9 ↖ 12: 10.7x ↙ 13: 10.3x ↑ 14: 10.4x ↘ 15: 10.5x → 16: 10.4x ↘ 17: 10.9x ↑ 18: 10.8x ↓ 19: 10.7x ↖ 20: 10.0 ↓ <hr/> Serie 104.6 Total 206.4
60 Skud 	21: 10.2x ↗ 22: 10.4x ↑ 23: 10.0 ↘ 24: 10.6x ↗ 25: 10.5x → 26: 10.7x ↘ 27: 9.7 → 28: 10.8x ↘ 29: 10.8x ↗ 30: 10.3x ↘ <hr/> Serie 104.0 Total 310.4	60 Skud 	31: 10.5x ↑ 32: 10.1 ↘ 33: 10.3x ↑ 34: 9.2 → 35: 10.6x ↘ 36: 10.0 ↗ 37: 10.5x ← 38: 10.6x ← 39: 10.2x → 40: 10.0 → <hr/> Serie 102.0 Total 412.4
60 Skud 	41: 10.8x ↘ 42: 10.6x ↑ 43: 10.5x ↙ 44: 10.2x ↗ 45: 10.5x ← 46: 10.0 ← 47: 10.1 ↗ 48: 10.3x ↗ 49: 10.6x ↗ 50: 10.0 → <hr/> Serie 103.6 Total 516.0	60 Skud 	51: 10.0 → 52: 10.2x → 53: 10.3x → 54: 10.8x ↑ 55: 10.2x ↓ 56: 10.4x → 57: 10.4x ↙ 58: 10.1 ↓ 59: 10.6x ↑ 60: 10.7x → <hr/> Serie 103.7 Total 619.7

Hold	Skive	Alexander Helleskov			
3	3				
10m	Trehøje Skytteforening	H	R		
	10 meter stævne	Aalborg Skyttekreds			
Prøve		1: 9.4 ↙ 2: 10.5x ← 3: 10.3x → 4: 9.3 → 5: 10.8x ↗ 6: 10.0 → 7: 9.7 → 8: 9.5 ↘ 9: 10.0 → 10: 10.4x → Serie 99.9 Total 0.0	Prøve		11: 10.3x ← 12: 10.5x ↗ 13: 10.1 → 14: 10.3x ↑ 15: 9.9 ↑ 16: 9.7 ← 17: 10.6x ↘ 18: 10.6x ↗ 19: 10.3x ← 20: 10.1 → Serie 102.4 Total 0.0
60 Skud		1: 10.6x ↗ 2: 9.8 ← 3: 9.9 ↘ 4: 10.5x ← 5: 9.9 → 6: 10.1 ← 7: 10.8x ↗ 8: 10.1 → 9: 10.6x ↘ 10: 10.3x ← Serie 102.6 Total 102.6	60 Skud		11: 10.3x ↓ 12: 10.2x ↓ 13: 10.7x ← 14: 10.4x ↑ 15: 10.4x ↑ 16: 10.1 ↑ 17: 10.6x ↘ 18: 10.5x ↑ 19: 9.4 ↗ 20: 10.7x ↑ Serie 103.3 Total 205.9
60 Skud		21: 9.9 ← 22: 9.9 ← 23: 10.6x ↗ 24: 10.3x ↗ 25: 10.6x ↘ 26: 10.0 → 27: 10.7x ↗ 28: 10.6x ↘ 29: 10.4x ↗ 30: 9.9 → Serie 102.9 Total 308.8	60 Skud		31: 10.4x ↑ 32: 10.4x ↑ 33: 10.5x ↓ 34: 10.4x ↓ 35: 10.0 ← 36: 10.7x ↑ 37: 10.0 ↑ 38: 10.7x ↑ 39: 10.8x ↘ 40: 9.9 ↗ Serie 103.8 Total 412.6
60 Skud		41: 10.7x ↗ 42: 10.7x ← 43: 10.4x ← 44: 10.3x ← 45: 10.1 ↑ 46: 10.8x ↗ 47: 10.8x ↑ 48: 10.5x ↗ 49: 9.9 → 50: 10.2x → Serie 104.4 Total 517.0	60 Skud		51: 10.4x ↗ 52: 10.6x ↑ 53: 10.2x ↗ 54: 10.4x → 55: 10.5x ↑ 56: 10.6x ← 57: 9.8 ↑ 58: 10.8x ↗ 59: 10.0 ↗ 60: 9.6 ← Serie 102.9 Total 619.9

10 meter stævne		Aalborg Skyttekreds	
Prøve 	1: 9.8 ↓ 2: 10.7x ↙ 3: 9.4 ↘ 4: 8.7 ← 5: 9.2 ← 6: 10.1 ← 7: 10.0 ← 8: 10.6x ↗ 9: 10.2x → 10: 10.1 ← Serie 98.8 Total 0.0	Prøve 	11: 10.3x ↙ 12: 10.2x ↗ 13: 10.9x ↓ 14: 9.8 ↑ 15: 10.6x ↙ Serie 51.8 Total 0.0
60 Skud 	1: 9.3 ↙ 2: 10.0 ↑ 3: 10.6x ← 4: 10.3x ↘ 5: 10.0 → 6: 10.2x ↗ 7: 10.6x ↓ 8: 10.1 ↗ 9: 9.6 ↘ 10: 10.2x ↘ Serie 100.9 Total 100.9	60 Skud 	11: 10.3x ↙ 12: 10.7x ↘ 13: 9.9 → 14: 9.2 ↙ 15: 10.1 ↗ 16: 10.7x ↗ 17: 10.0 ↑ 18: 10.1 ↑ 19: 10.5x ↑ 20: 10.5x ↗ Serie 102.0 Total 202.9
60 Skud 	21: 9.7 ↘ 22: 10.2x ↘ 23: 9.8 ↓ 24: 10.3x ↙ 25: 10.8x ↘ 26: 10.7x → 27: 10.7x ← 28: 10.6x ↗ 29: 9.7 ↙ 30: 9.7 ← Serie 102.2 Total 305.1	60 Skud 	31: 10.5x ↗ 32: 10.5x ↗ 33: 9.8 → 34: 10.2x ↑ 35: 10.7x ↑ 36: 10.0 ↑ 37: 10.2x ↓ 38: 9.2 ↘ 39: 10.3x ↑ 40: 10.3x ↗ Serie 101.7 Total 406.8
60 Skud 	41: 9.3 ↑ 42: 9.3 ↑ 43: 10.3x ↑ 44: 10.6x ↑ 45: 10.0 ↑ 46: 10.2x → 47: 10.5x ↓ 48: 10.2x ↘ 49: 10.6x ↗ 50: 10.7x ↗ Serie 101.7 Total 508.5	60 Skud 	51: 10.5x ↗ 52: 10.2x ↙ 53: 10.7x ↗ 54: 10.7x ↗ 55: 10.4x ↘ 56: 10.6x ← 57: 10.8x ↓ 58: 10.1 ↙ 59: 10.7x → 60: 10.2x ↘ Serie 104.9 Total 613.4

Prøve 	1: 8.6 ↗ 2: 9.5 ↑ 3: 10.2x ↗ 4: 10.6x ↑ 5: 10.6x → 6: 10.5x ↓ 7: 10.6x ↗ 8: 10.3x ↑ 9: 10.0 → 10: 10.8x ↓ Serie 101.7 Total 0.0	Prøve 	11: 10.7x → 12: 10.6x ↘ 13: 10.3x ↗ 14: 9.5 → Serie 41.1 Total 0.0
-----------	------------------------------------------------------------------------------------------------------------------------------------------------------------------	-----------	-----------------------------------------------------------------------------------

60 Skud 	1: 10.4x ↖ 2: 9.2 ↑ 3: 10.5x → 4: 9.4 ↓ 5: 8.5 → 6: 9.9 ↓ 7: 10.5x ↑ 8: 9.7 ↘ 9: 10.4x ← 10: 9.8 ↗ Serie 98.3 Total 98.3	60 Skud 	11: 9.4 → 12: 10.2x ↘ 13: 10.1 ↗ 14: 10.3x ↗ 15: 9.8 → 16: 10.3x ← 17: 10.6x → 18: 10.1 ↗ 19: 10.5x ↗ 20: 9.3 ↗ Serie 100.6 Total 198.9
-------------	-----------------------------------------------------------------------------------------------------------------------------------------------------------	-------------	--------------------------------------------------------------------------------------------------------------------------------------------------------------------------

60 Skud 	21: 10.8x ↗ 22: 10.0 ↗ 23: 10.4x ↗ 24: 10.7x ↗ 25: 9.4 → 26: 9.5 ↖ 27: 10.3x ↓ 28: 10.5x ↗ 29: 10.2x → 30: 10.5x ← Serie 102.3 Total 301.2	60 Skud 	31: 10.5x ← 32: 10.1 ↓ 33: 10.2x ↓ 34: 10.4x ↘ 35: 10.5x ↗ 36: 9.2 ↗ 37: 9.7 → 38: 10.1 ↑ 39: 9.8 ↗ 40: 10.5x ← Serie 101.0 Total 402.2
-------------	-----------------------------------------------------------------------------------------------------------------------------------------------------------------------------	-------------	--------------------------------------------------------------------------------------------------------------------------------------------------------------------------

60 Skud 	41: 10.6x ↗ 42: 9.5 ↑ 43: 10.2x ↗ 44: 10.3x ← 45: 10.5x ↖ 46: 10.4x ↖ 47: 10.9x ↓ 48: 10.3x → 49: 9.8 ↑ 50: 10.3x ← Serie 102.8 Total 505.0	60 Skud 	51: 10.3x ↑ 52: 10.2x ← 53: 10.0 ← 54: 10.1 ↗ 55: 10.4x ← 56: 10.2x ↘ 57: 9.5 → 58: 5.7 → 59: 8.9 → 60: 8.6 ↗ Serie 93.9 Total 598.9
-------------	------------------------------------------------------------------------------------------------------------------------------------------------------------------------------	-------------	-----------------------------------------------------------------------------------------------------------------------------------------------------------------------

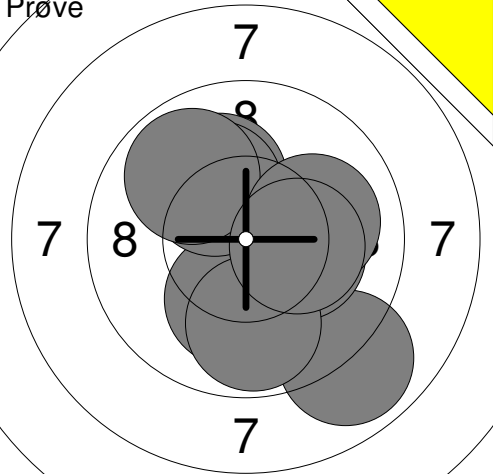
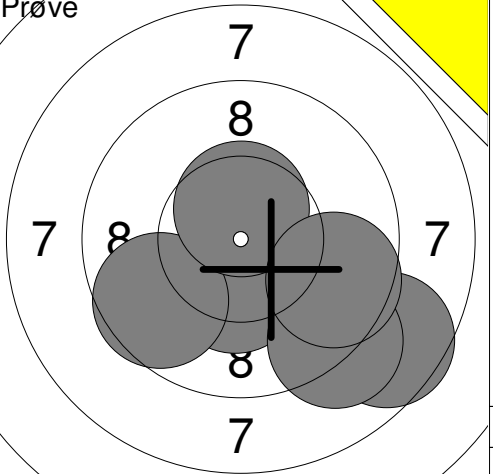

Prøve 	1: 8.9 ↘ 2: 10.3x ↘ 3: 10.1 ↘ 4: 10.1 ↗ 5: 10.2x ↗ 6: 9.9 ↗ 7: 10.2x → 8: 9.8 ↓ 9: 10.0 → 10: 10.3x → Serie 99.8 Total 0.0	Prøve 	11: 10.3x ↓ 12: 9.6 ↙ 13: 10.5x ↑ 14: 8.6 ↘ 15: 9.1 ↘ 16: 9.6 → Serie 57.7 Total 0.0
-------------------------------------------------------------------------------------------	-------------------------------------------------------------------------------------------------------------------------------------------------------------	---------------------------------------------------------------------------------------------	-----------------------------------------------------------------------------------------------------------

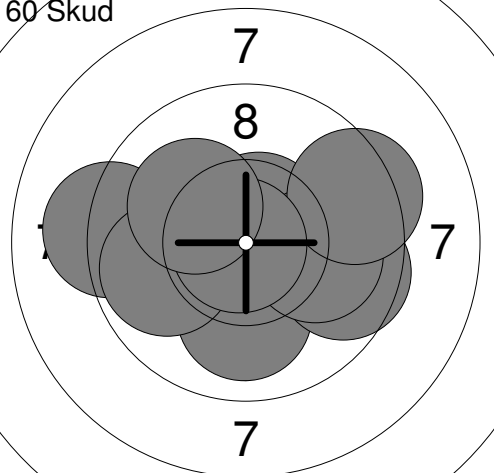
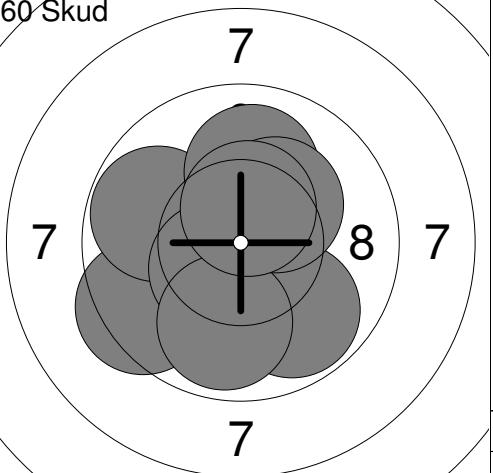
60 Skud 	1: 10.5x ↘ 2: 10.0 ↓ 3: 9.2 ← 4: 10.6x ↗ 5: 9.6 → 6: 10.0 → 7: 9.9 ← 8: 9.4 → 9: 10.9x ← 10: 10.1 ↗ Serie 100.2 Total 100.2	60 Skud 	11: 10.8x ↖ 12: 9.4 ↙ 13: 9.8 ↙ 14: 10.5x ↙ 15: 10.5x ↑ 16: 9.8 ↘ 17: 9.9 ↓ 18: 10.0 ↑ 19: 10.3x ↗ 20: 10.5x ↑ Serie 101.5 Total 201.7
----------------------------------------------------------------------------------------------	--------------------------------------------------------------------------------------------------------------------------------------------------------------	------------------------------------------------------------------------------------------------	-------------------------------------------------------------------------------------------------------------------------------------------------------------------------

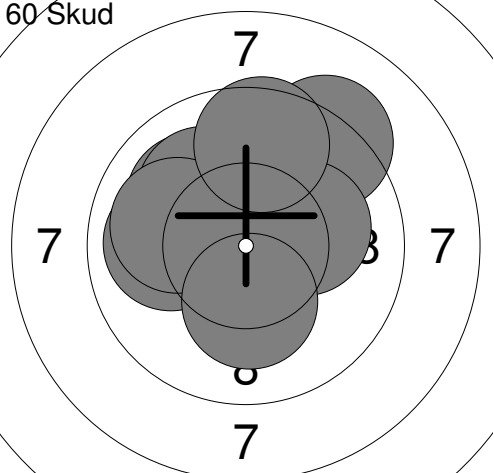
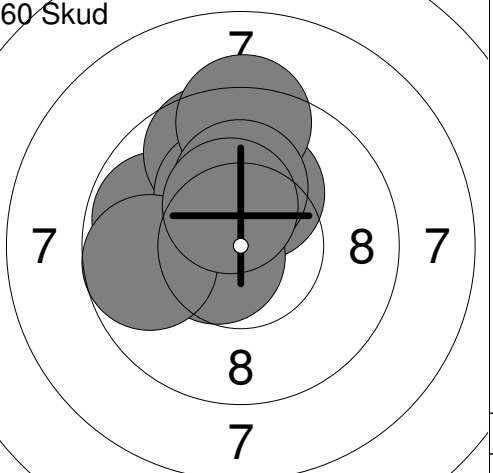
60 Skud 	21: 10.0 ↑ 22: 10.0 ↗ 23: 10.0 ← 24: 9.2 ↗ 25: 10.9x ↘ 26: 10.1 ↗ 27: 10.2x → 28: 10.0 ← 29: 10.2x ↓ 30: 9.6 ↑ Serie 100.2 Total 301.9	60 Skud 	31: 9.8 ← 32: 9.7 ↑ 33: 10.4x ↖ 34: 10.2x ↑ 35: 10.2x ↑ 36: 10.6x ← 37: 9.3 ↑ 38: 10.2x ↑ 39: 9.7 ← 40: 10.4x ↑ Serie 100.5 Total 402.4
-----------------------------------------------------------------------------------------------	-------------------------------------------------------------------------------------------------------------------------------------------------------------------------	-------------------------------------------------------------------------------------------------	--------------------------------------------------------------------------------------------------------------------------------------------------------------------------

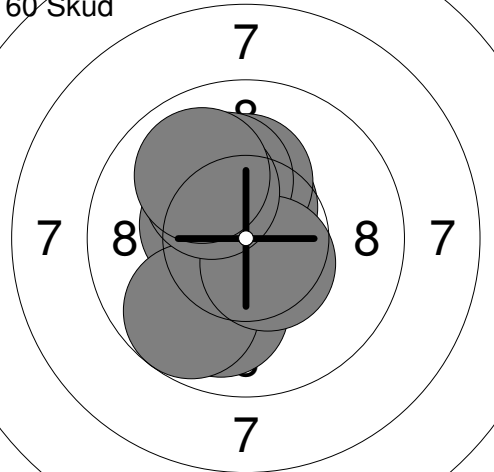
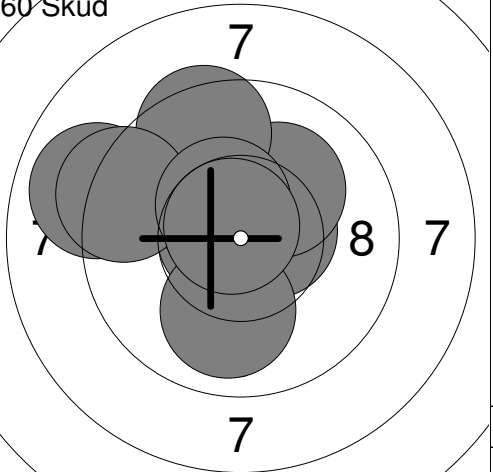
60 Skud 	41: 10.5x ↑ 42: 10.7x ↓ 43: 10.2x ↑ 44: 10.0 ↓ 45: 10.4x ↙ 46: 9.7 ↘ 47: 10.1 ↗ 48: 10.5x ↓ 49: 10.2x ↗ 50: 9.9 ↗ Serie 102.2 Total 504.6	60 Skud 	51: 10.6x → 52: 10.7x ← 53: 10.0 ↓ 54: 10.1 ↗ 55: 8.9 ← 56: 10.3x ↗ 57: 9.5 ↑ 58: 9.3 ← 59: 10.5x ↗ 60: 10.7x ↖ Serie 100.6 Total 605.2
-----------------------------------------------------------------------------------------------	----------------------------------------------------------------------------------------------------------------------------------------------------------------------------	-------------------------------------------------------------------------------------------------	--------------------------------------------------------------------------------------------------------------------------------------------------------------------------

Prøve 	1: 10.3x ↖ 2: 9.6 ↗ 3: 9.5 → 4: 10.0 ↑ 5: 10.4x ↗ 6: 10.0 ← 7: 9.7 → 8: 10.6x ↗ 9: 10.9x ↘ 10: 9.2 ← <hr/> Serie 100.2 Total 0.0	Prøve 	11: 10.0 ← 12: 9.3 ↑ 13: 10.0 ← 14: 10.4x → 15: 10.4x ↘ <hr/> Serie 50.1 Total 0.0
-----------	-------------------------------------------------------------------------------------------------------------------------------------------------------------------	-----------	------------------------------------------------------------------------------------------------------

60 Skud 	1: 10.6x ↗ 2: 10.5x → 3: 9.4 ↗ 4: 10.8x ↗ 5: 10.8x ↑ 6: 10.5x ↘ 7: 10.2x ← 8: 10.3x → 9: 10.1 ← 10: 10.5x ↘ <hr/> Serie 103.7 Total 103.7	60 Skud 	11: 10.0 ← 12: 10.6x ↗ 13: 10.5x ↗ 14: 10.6x ↘ 15: 10.0 ↘ 16: 9.9 ↘ 17: 10.4x ↘ 18: 10.4x ↘ 19: 10.3x ↗ 20: 10.2x ↗ <hr/> Serie 102.9 Total 206.6
-------------	----------------------------------------------------------------------------------------------------------------------------------------------------------------------------	-------------	------------------------------------------------------------------------------------------------------------------------------------------------------------------------------------

60 Skud 	21: 10.1 ← 22: 9.8 ↘ 23: 10.4x ↘ 24: 10.0 ← 25: 10.1 ← 26: 10.4x → 27: 10.1 ↘ 28: 10.9x ↘ 29: 10.2x → 30: 9.7 ↗ <hr/> Serie 101.7 Total 308.3	60 Skud 	31: 9.6 → 32: 10.6x ← 33: 10.9x ↗ 34: 10.4x ↗ 35: 10.5x ← 36: 10.1 → 37: 10.5x ↗ 38: 10.7x → 39: 9.3 ← 40: 10.2x ↑ <hr/> Serie 102.8 Total 411.1
-------------	--------------------------------------------------------------------------------------------------------------------------------------------------------------------------------	-------------	-----------------------------------------------------------------------------------------------------------------------------------------------------------------------------------

60 Skud 	41: 10.5x ↗ 42: 10.0 ↑ 43: 10.0 ↘ 44: 10.7x ↘ 45: 10.2x ↗ 46: 10.3x → 47: 10.5x → 48: 10.4x ← 49: 10.3x ↘ 50: 10.3x ↘ <hr/> Serie 103.2 Total 514.3	60 Skud 	51: 10.2x ↘ 52: 10.5x → 53: 10.8x ← 54: 10.5x ↗ 55: 10.3x ↑ 56: 9.7 → 57: 10.7x → 58: 10.1 ↘ 59: 9.9 ↘ 60: 10.4x ↑ <hr/> Serie 103.1 Total 617.4
-------------	--------------------------------------------------------------------------------------------------------------------------------------------------------------------------------------	-------------	-----------------------------------------------------------------------------------------------------------------------------------------------------------------------------------

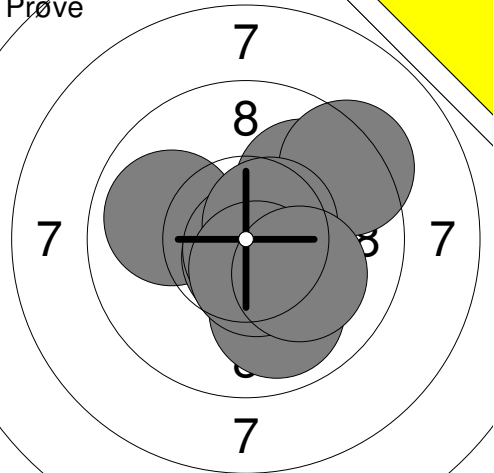
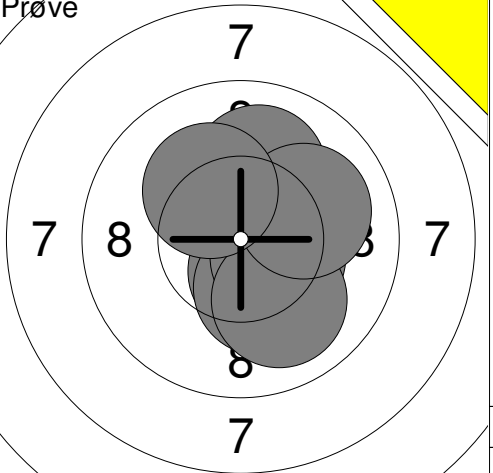
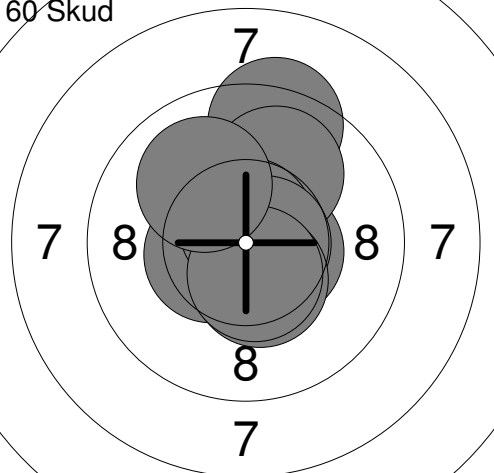
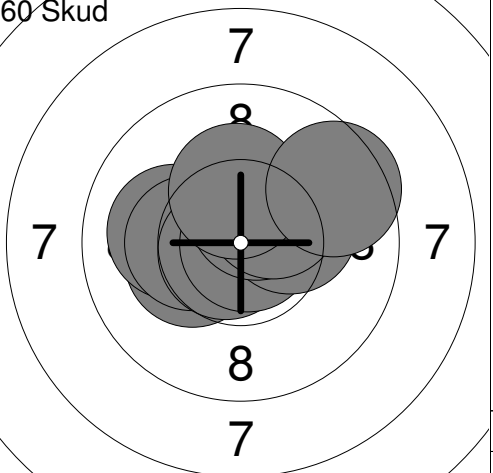
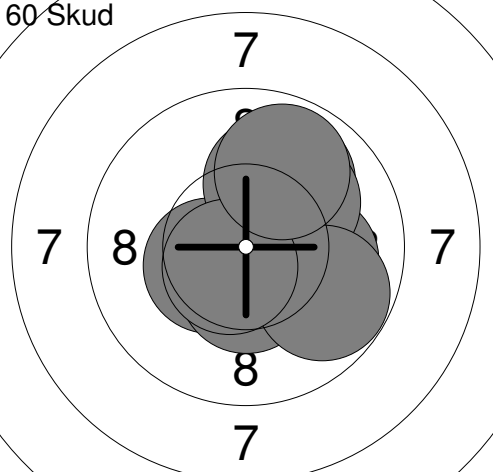
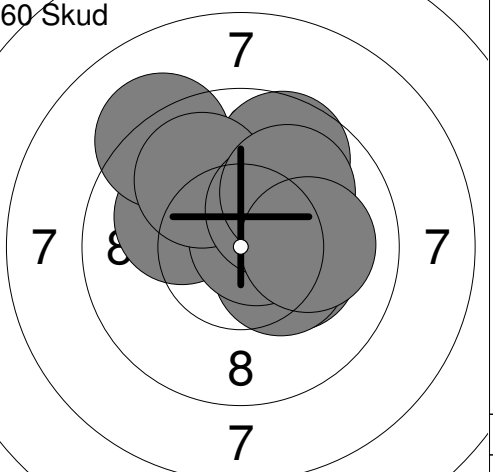
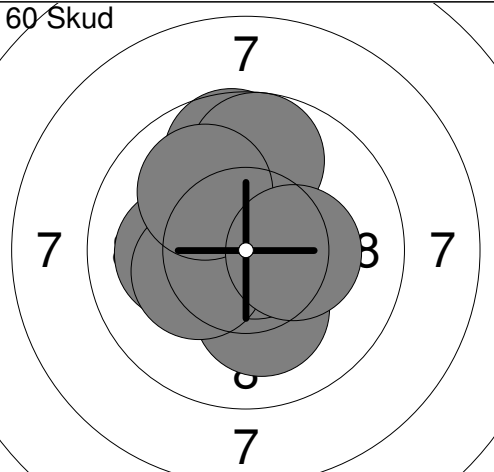
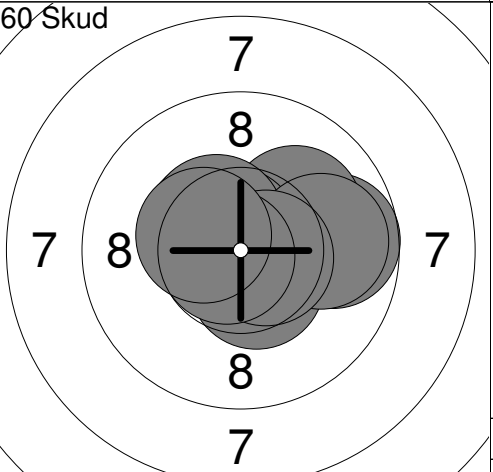
Hold	Skive	Lars Ørum		
3	8			
10m	Aalborg Skyttekreds	H	R	
	10 meter stævne	Aalborg Skyttekreds		
Prøve		1: 9.9 ↙		11: 10.5x ↓
		2: 10.7x ↓		12: 10.3x ↓
		3: 10.2x ↘		13: 10.4x ↘
		4: 9.9 ↗		14: 10.0 ↓
		5: 10.8x ↓		15: 10.0 ↑
		6: 9.9 ↓		16: 10.0 ↗
		7: 9.3 ↗		17: 10.2x ↗
		8: 10.6x ↗		
		9: 10.5x ↓		
		10: 10.1 ↘		
		Serie 101.9		Serie 71.4
		Total 0.0		Total 0.0
60 Skud		1: 10.3x ↑		11: 10.3x ←
		2: 10.5x →		12: 10.1 ←
		3: 9.4 ↑		13: 10.3x ←
		4: 10.5x ←		14: 10.7x ↙
		5: 10.0 ↑		15: 10.9x →
		6: 10.7x ↑		16: 10.3x →
		7: 10.7x →		17: 10.5x ↗
		8: 10.4x ↓		18: 10.3x ↗
		9: 10.5x ↓		19: 10.3x ↑
		10: 10.0 ↗		20: 9.5 ↗
		Serie 103.0		Serie 103.2
		Total 103.0		Total 206.2
60 Skud		21: 9.9 ↗		31: 10.1 ↙
		22: 10.6x →		32: 10.3x →
		23: 10.4x ←		33: 10.3x ↘
		24: 10.1 ↑		34: 9.7 ↑
		25: 10.1 →		35: 9.2 ↗
		26: 10.4x ↓		36: 10.7x ↗
		27: 10.1 ↗		37: 9.9 ↗
		28: 9.8 ↘		38: 10.3x ↗
		29: 10.6x ↙		39: 10.0 ↗
		30: 9.9 ↑		40: 10.1 →
		Serie 101.9		Serie 100.6
		Total 308.1		Total 408.7
60 Skud		41: 10.5x ↖		51: 10.5x ↓
		42: 9.7 ↑		52: 9.7 →
		43: 10.2x ↓		53: 10.5x ↖
		44: 10.1 ←		54: 10.1 ↗
		45: 10.6x ↗		55: 10.7x ↗
		46: 10.8x →		56: 10.5x ↗
		47: 9.8 ↑		57: 9.9 →
		48: 10.3x ←		58: 10.6x →
		49: 10.0 ↗		59: 10.7x ←
		50: 10.3x →		60: 10.4x ←
		Serie 102.3		Serie 103.6
		Total 511.0		Total 614.6

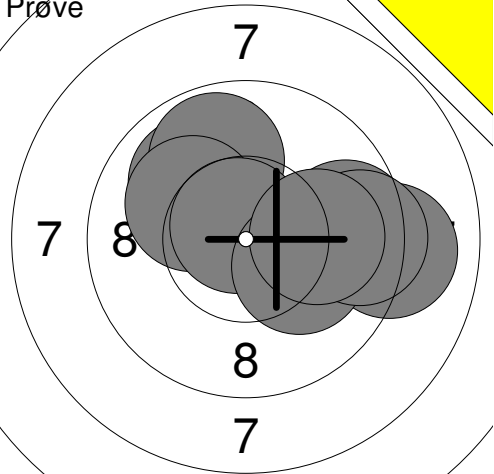
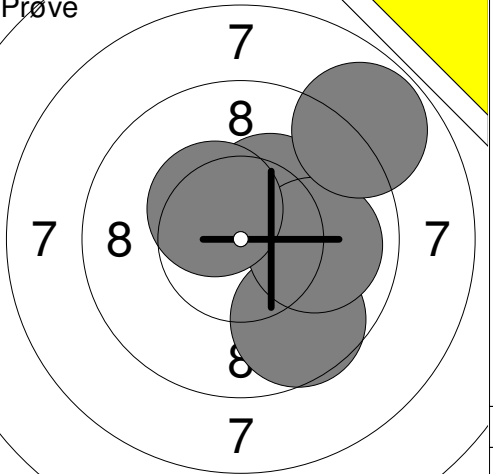
<b>Prøve</b> 	1: 10.0 ↗ 2: 10.4x ↗ 3: 9.8 ↗ 4: 10.1 ↗ 5: 9.6 → 6: 9.0 → 7: 10.7x ↗ 8: 10.2x ↘ 9: 9.4 → 10: 10.0 → <hr/> <b>Serie</b> 99.2 <b>Total</b> 0.0	<b>Prøve</b> 	11: 10.3x ↗ 12: 9.6 ↘ 13: 10.0 → 14: 8.8 ↗ 15: 10.4x ↗ <hr/> <b>Serie</b> 49.1 <b>Total</b> 0.0
--------------------------------------------------------------------------------------------------	-------------------------------------------------------------------------------------------------------------------------------------------------------------------------------	----------------------------------------------------------------------------------------------------	-------------------------------------------------------------------------------------------------------------------

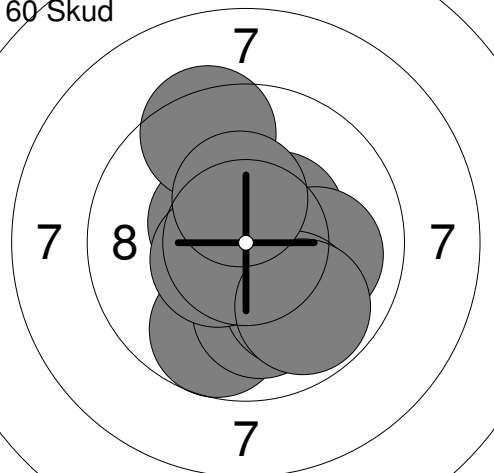
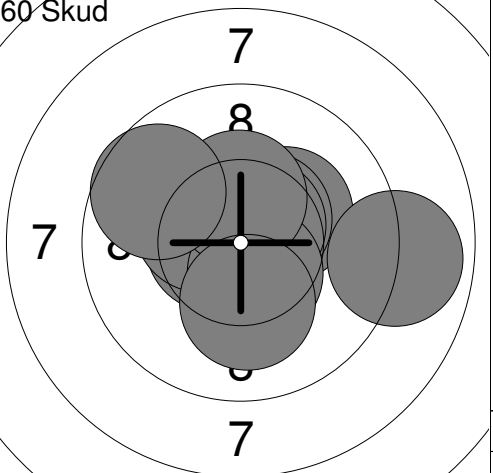
<b>60 Skud</b> 	1: 10.5x ↗ 2: 9.4 ↗ 3: 9.7 ↘ 4: 10.4x ↗ 5: 10.0 ↘ 6: 10.0 → 7: 10.0 ↘ 8: 10.5x ↙ 9: 9.8 ↘ 10: 10.4x ↑ <hr/> <b>Serie</b> 100.7 <b>Total</b> 100.7	<b>60 Skud</b> 	11: 10.6x ← 12: 10.3x ↗ 13: 10.5x ↗ 14: 10.6x ↗ 15: 10.4x ↙ 16: 10.5x ↘ 17: 10.4x ↑ 18: 8.9 → 19: 10.2x ↘ 20: 9.7 ↗ <hr/> <b>Serie</b> 102.1 <b>Total</b> 202.8
-----------------------------------------------------------------------------------------------------	------------------------------------------------------------------------------------------------------------------------------------------------------------------------------------	-------------------------------------------------------------------------------------------------------	--------------------------------------------------------------------------------------------------------------------------------------------------------------------------------------------------

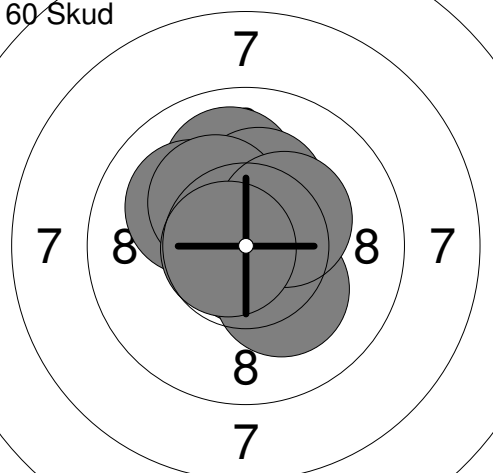
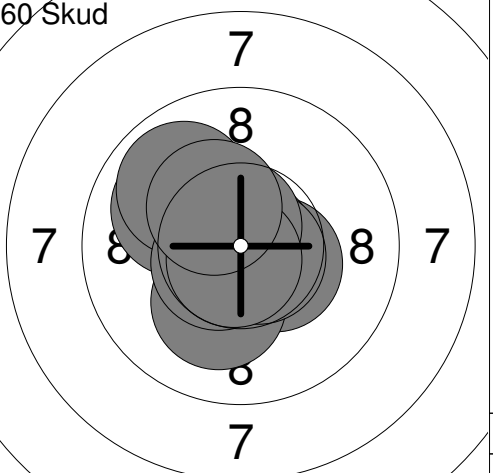
<b>60 Skud</b> 	21: 10.8x ↘ 22: 10.5x ↗ 23: 10.0 ↑ 24: 10.2x ↘ 25: 10.4x ↗ 26: 10.3x ↑ 27: 10.1 ↗ 28: 10.2x ↗ 29: 10.3x ↗ 30: 10.7x ← <hr/> <b>Serie</b> 103.5 <b>Total</b> 306.3	<b>60 Skud</b> 	31: 10.0 ↙ 32: 10.4x → 33: 10.2x ↘ 34: 9.9 ↗ 35: 10.9x → 36: 10.6x ↙ 37: 10.7x → 38: 10.7x ↑ 39: 10.7x ↘ 40: 10.3x ↗ <hr/> <b>Serie</b> 104.4 <b>Total</b> 410.7
------------------------------------------------------------------------------------------------------	----------------------------------------------------------------------------------------------------------------------------------------------------------------------------------------------------	--------------------------------------------------------------------------------------------------------	---------------------------------------------------------------------------------------------------------------------------------------------------------------------------------------------------

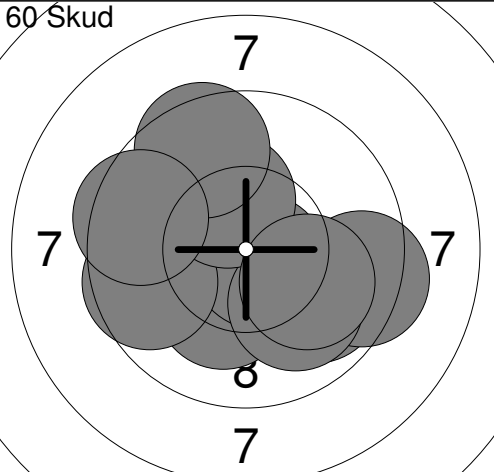
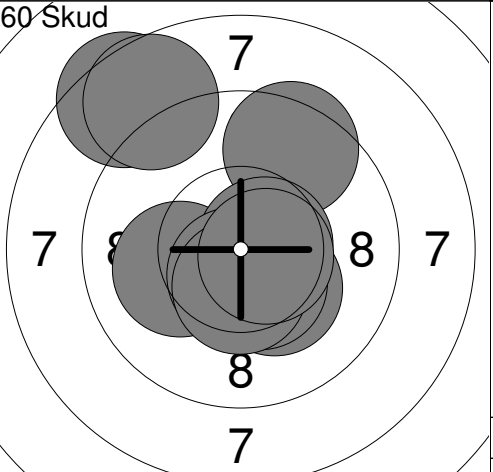
<b>60 Skud</b> 	41: 10.2x ↘ 42: 10.7x ↘ 43: 9.9 ↘ 44: 9.4 → 45: 9.6 ← 46: 10.0 ↘ 47: 10.3x ↗ 48: 9.5 ↗ 49: 10.0 ↘ 50: 9.5 ↗ <hr/> <b>Serie</b> 99.1 <b>Total</b> 509.8	<b>60 Skud</b> 	51: 10.1 ← 52: 10.3x ↘ 53: 8.4 ↗ 54: 9.5 ↗ 55: 10.6x → 56: 10.4x ↘ 57: 10.6x ↘ 58: 10.5x ↘ 59: 10.6x → 60: 8.7 ↗ <hr/> <b>Serie</b> 99.7 <b>Total</b> 609.5
------------------------------------------------------------------------------------------------------	-----------------------------------------------------------------------------------------------------------------------------------------------------------------------------------------	--------------------------------------------------------------------------------------------------------	----------------------------------------------------------------------------------------------------------------------------------------------------------------------------------------------

	<b>10 meter stævne</b>	<b>Aalborg Skyttekreds</b>
--	------------------------	----------------------------

<b>Prøve</b> 	1: 9.8 → 2: 10.5x → 3: 9.3 → 4: 9.3 → 5: 10.5x → 6: 9.4 → 7: 9.3 → 8: 9.9 → 9: 10.6x → 10: 10.3x → <hr/> Serie 98.9 Total 0.0	<b>Prøve</b> 	11: 10.2x ↑ 12: 8.7 → 13: 10.2x ← 14: 10.5x ↗ 15: 8.6 → 16: 10.2x ↗ 17: 9.6 → 18: 9.7 → 19: 10.2x ↓ 20: 10.1 ↓ <hr/> Serie 98.0 Total 0.0
------------------	----------------------------------------------------------------------------------------------------------------------------------------------------------------	------------------	----------------------------------------------------------------------------------------------------------------------------------------------------------------------------

<b>Prøve</b> 	21: 10.0 → 22: 10.0 → 23: 10.3x → 24: 10.2x → 25: 10.2x → 26: 9.9 ↓ 27: 10.5x ↗ <hr/> Serie 71.1 Total 0.0	<b>60 Skud</b> 	1: 10.0 ↑ 2: 10.3x ← 3: 10.0 → 4: 9.5 → 5: 9.4 ↓ 6: 10.6x ↓ 7: 10.2x ↗ 8: 9.7 → 9: 9.6 ↓ 10: 10.8x ↗ <hr/> Serie 100.1 Total 100.1
------------------	------------------------------------------------------------------------------------------------------------------------------------	--------------------	---------------------------------------------------------------------------------------------------------------------------------------------------------------------

<b>60 Skud</b> 	11: 9.6 ↗ 12: 10.9x ↓ 13: 10.3x ↓ 14: 10.8x ↓ 15: 10.1 → 16: 10.5x → 17: 9.4 ↓ 18: 10.1 ↓ 19: 10.4x ↗ 20: 10.2x ↓ <hr/> Serie 102.3 Total 202.4	<b>60 Skud</b> 	21: 10.5x ↓ 22: 10.2x ↓ 23: 10.5x ↓ 24: 10.5x ↑ 25: 10.4x ↓ 26: 10.1 ↓ 27: 10.2x ↓ 28: 10.0 ↗ 29: 9.4 ← 30: 10.5x ↗ <hr/> Serie 102.3 Total 304.7
--------------------	----------------------------------------------------------------------------------------------------------------------------------------------------------------------------------	--------------------	------------------------------------------------------------------------------------------------------------------------------------------------------------------------------------

<b>60 Skud</b> 	31: 10.0 ↑ 32: 10.2x ↑ 33: 10.7x ↗ 34: 10.2x → 35: 10.4x ← 36: 9.6 ↗ 37: 10.3x ↓ 38: 10.4x ↓ 39: 9.4 → 40: 10.4x → <hr/> Serie 101.6 Total 406.3	<b>60 Skud</b> 	41: 9.9 ↓ 42: 10.2x ↓ 43: 10.0 ← 44: 10.3x ↗ 45: 10.5x ↑ 46: 10.4x ↗ 47: 10.6x → 48: 10.6x ↓ 49: 9.4 → 50: 10.2x ↗ <hr/> Serie 102.1 Total 508.4
--------------------	-----------------------------------------------------------------------------------------------------------------------------------------------------------------------------------	--------------------	-----------------------------------------------------------------------------------------------------------------------------------------------------------------------------------

<b>60 Skud</b> 	51: 10.4x → 52: 9.8 → 53: 10.4x → 54: 10.3x ↓ 55: 10.1 ↓ 56: 10.2x ↗ 57: 9.8 → 58: 10.6x ← 59: 9.9 ↓ 60: 10.1 ↓ <hr/> Serie 101.6 Total 610.0		
--------------------	--------------------------------------------------------------------------------------------------------------------------------------------------------------------------------	--	--

	10 meter stævne	Aalborg Skyttekreds
--	-----------------	---------------------

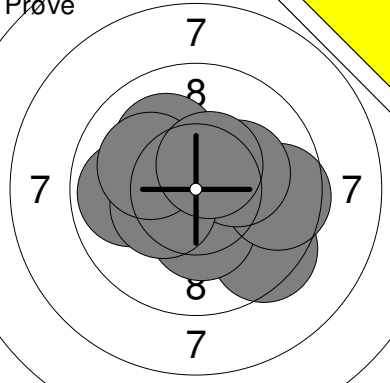
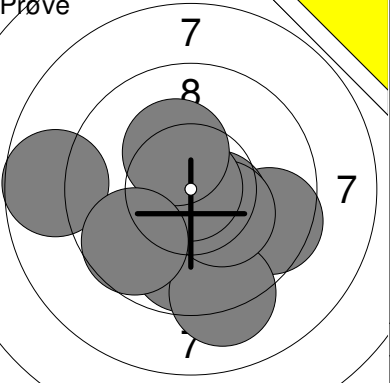
Prøve	10 meter stævne	Prøve	Aalborg Skyttekreds
	1: 10.1 ↗ 2: 10.4x → 3: 9.5 ↘ 4: 10.3x ↘ 5: 9.6 → 6: 9.9 ← 7: 10.2x → 8: 10.4x ← 9: 10.1 ↗ 10: 10.5x ↗		11: 10.0 ↘ 12: 9.5 → 13: 8.7 ← 14: 10.5x ↘ 15: 9.8 ↘ 16: 9.1 ↘ 17: 10.3x ↘ 18: 10.9x ↗ 19: 10.3x ↗ 20: 9.7 ↘
	Serie 101.0		Serie 98.8
	Total 0.0		Total 0.0

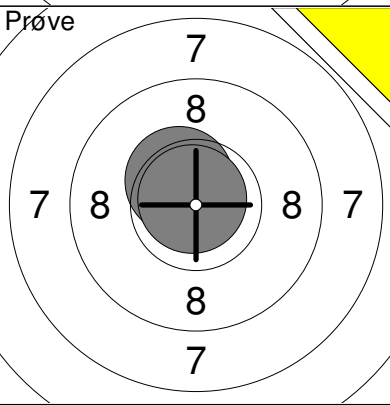
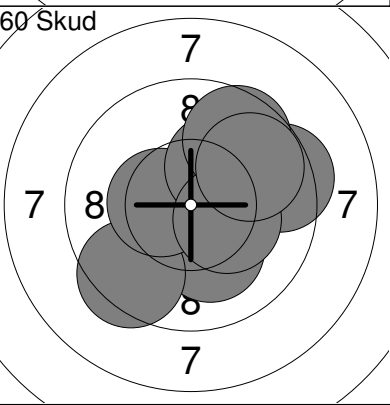
Prøve	10 meter stævne	60 Skud	Aalborg Skyttekreds
	21: 10.5x ↗ 22: 10.8x ↗		1: 10.3x ↘ 2: 10.8x ↘ 3: 10.2x ↘ 4: 9.4 ↘ 5: 10.5x ← 6: 9.4 → 7: 10.2x ↗ 8: 10.3x → 9: 9.6 ↗ 10: 9.8 ↗
	Serie 21.3		Serie 100.5
	Total 0.0		Total 100.5

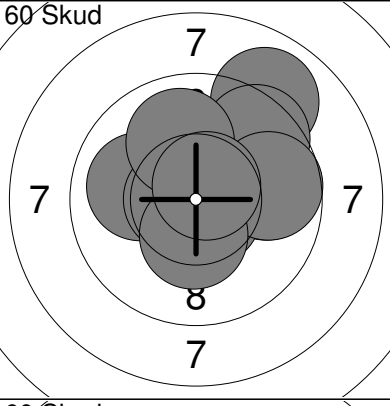
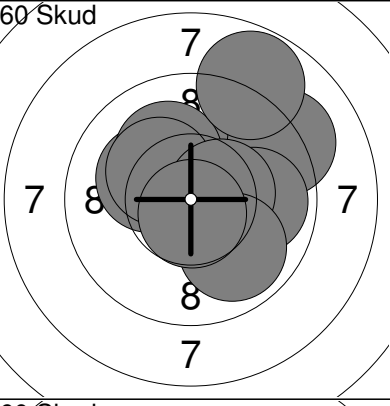
60 Skud	10 meter stævne	60 Skud	Aalborg Skyttekreds
	11: 9.8 → 12: 10.0 ← 13: 10.7x ← 14: 9.0 ↗ 15: 10.7x ↘ 16: 9.5 ↗ 17: 9.7 → 18: 10.4x ↘ 19: 10.0 ↗ 20: 10.7x ↗		21: 10.3x ↗ 22: 9.2 ↗ 23: 10.2x ↗ 24: 10.1 ↗ 25: 10.3x ↗ 26: 9.9 → 27: 10.4x → 28: 9.9 ↘ 29: 8.8 ↗ 30: 10.7x ↘
	Serie 100.5		Serie 99.8
	Total 201.0		Total 300.8

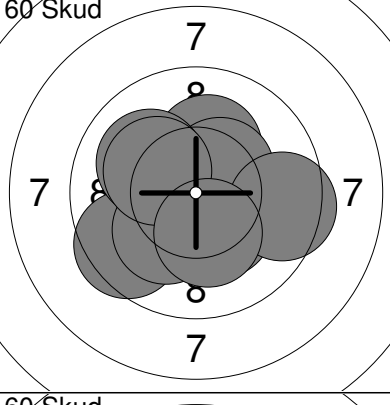
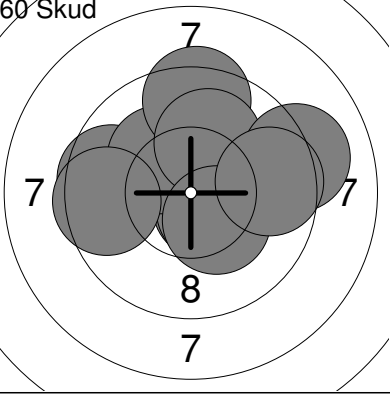
60 Skud	10 meter stævne	60 Skud	Aalborg Skyttekreds
	31: 10.2x ↗ 32: 10.5x ↘ 33: 9.5 ↘ 34: 10.3x ↘ 35: 10.2x ↘ 36: 10.4x ↗ 37: 10.1 ↗ 38: 10.2x ↗ 39: 9.5 → 40: 10.3x ↘		41: 10.6x ↘ 42: 10.5x ↘ 43: 9.6 ← 44: 10.2x ↗ 45: 9.4 ↗ 46: 10.1 ↗ 47: 9.1 → 48: 9.5 ← 49: 10.3x ↘ 50: 9.6 →
	Serie 101.2		Serie 98.9
	Total 402.0		Total 500.9

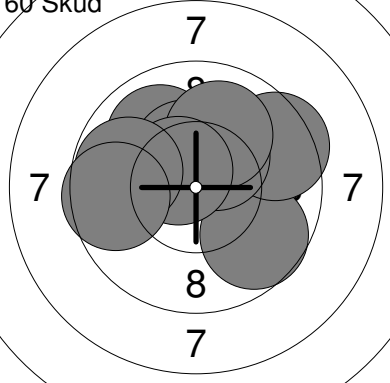
60 Skud	10 meter stævne		
	51: 10.0 → 52: 9.7 ↘ 53: 10.0 ↗ 54: 9.5 → 55: 10.4x ↗ 56: 10.3x ↗ 57: 10.0 ↗ 58: 10.6x ↗ 59: 9.8 ← 60: 9.6 ←		
	Serie 99.9		
	Total 600.8		

Hold	Skive	Henrik Frankfurth			
3	12				
10m	Aalborg Skyttekreds	H	R		
	10 meter stævne	Aalborg Skyttekreds			
Prøve		1: 9.8 ↓ 2: 8.6 ↓ 3: 10.2x ↓ 4: 9.6 ↓ 5: 9.9 ↓ 6: 10.0 ↓ 7: 10.1 → 8: 10.4x ↓ 9: 10.0 ↗ 10: 9.8 ↙ Serie 98.4 Total 0.0	Prøve		11: 10.1 ↓ 12: 9.3 → 13: 10.1 ↓ 14: 10.7x ← 15: 10.0 ↓ 16: 10.3x → 17: 9.8 ↓ 18: 10.3x ↓ 19: 9.6 ← 20: 10.6x ↙ Serie 100.8 Total 0.0
60 Skud		1: 10.4x ↗ 2: 9.9 ↑ 3: 9.3 ↗ 4: 10.7x → 5: 10.3x ← 6: 10.4x ↗ 7: 10.7x → 8: 9.3 ← 9: 9.8 → 10: 9.9 ↑ Serie 100.7 Total 100.7	60 Skud		11: 10.5x ↖ 12: 10.1 ↓ 13: 9.7 → 14: 9.9 ↓ 15: 10.1 → 16: 10.7x ↗ 17: 9.5 ↖ 18: 9.4 ↓ 19: 10.4x ↑ 20: 10.5x ↑ Serie 100.8 Total 201.5
60 Skud		21: 10.2x ↗ 22: 10.1 ↓ 23: 9.1 → 24: 9.4 ↓ 25: 10.0 → 26: 9.8 ← 27: 9.8 ↓ 28: 10.1 → 29: 10.4x ← 30: 9.7 ↓ Serie 98.6 Total 300.1	60 Skud		31: 9.1 ↗ 32: 10.2x ↓ 33: 9.4 ↗ 34: 10.2x ← 35: 10.4x ↓ 36: 10.1 ↓ 37: 10.6x ← 38: 10.9x ↙ 39: 10.2x ↑ 40: 10.3x ← Serie 101.4 Total 401.5
60 Skud		41: 9.8 ← 42: 10.4x ↓ 43: 10.7x ← 44: 10.3x ↓ 45: 9.6 ↓ 46: 9.7 ↑ 47: 8.6 ← 48: 10.7x → 49: 10.5x ↗ 50: 10.5x ↗ Serie 100.8 Total 502.3	60 Skud		51: 10.7x ↓ 52: 9.2 ↓ 53: 10.0 ↑ 54: 8.8 ← 55: 10.3x ↗ 56: 10.0 → 57: 10.2x ↗ 58: 10.3x ↓ 59: 10.5x ↓ 60: 10.5x ↗ Serie 100.5 Total 602.8

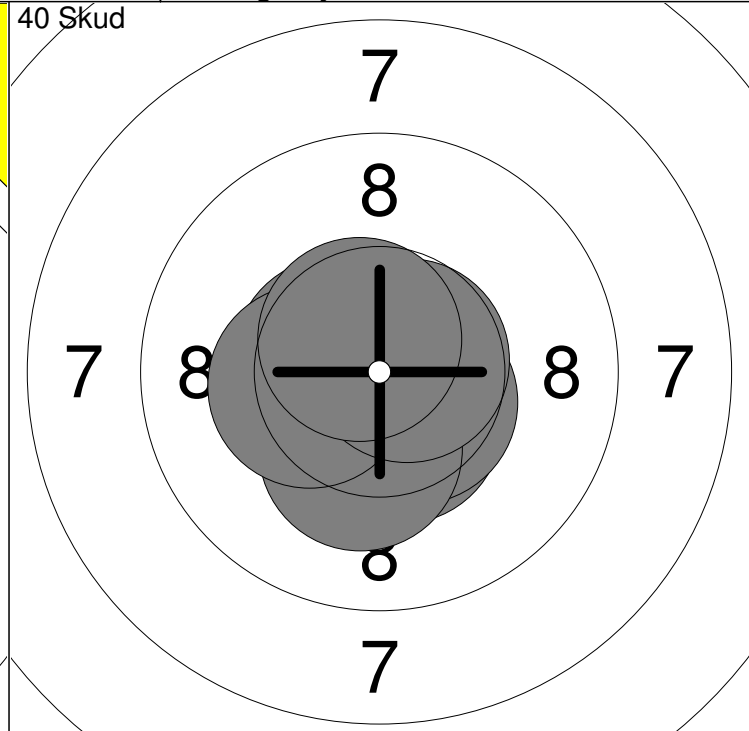
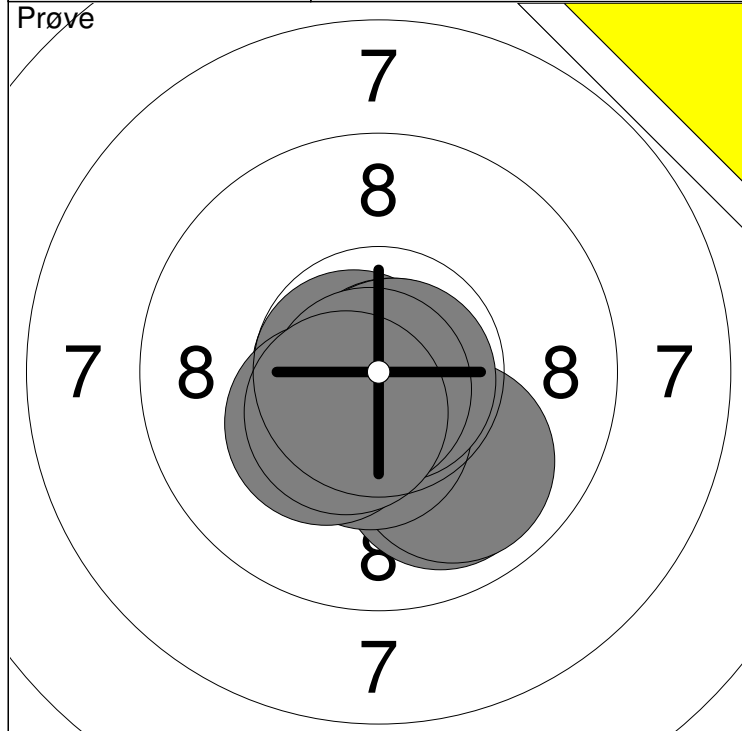

1: 9.9 ↘	6: 10.3x ↙	Serie	104.7
2: 9.9 ↘	7: 10.8x ↘		
3: 10.4x ↘	8: 10.8x →	Total	0.0
4: 10.6x ↙	9: 10.8x ↘		
5: 10.7x ←	10: 10.5x ↘		

1: 10.4x ↘	6: 10.6x ↙	Serie	105.1
2: 10.7x ↘	7: 10.3x ↘		
3: 10.5x ↙	8: 10.3x ↙	Total	105.1
4: 10.5x ↘	9: 10.7x →		
5: 10.5x ↘	10: 10.6x ↖		

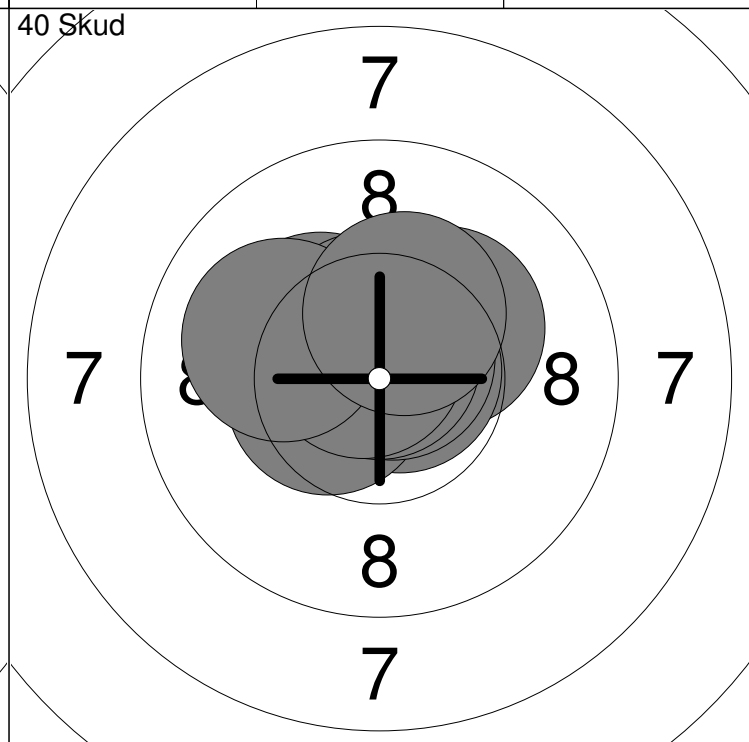
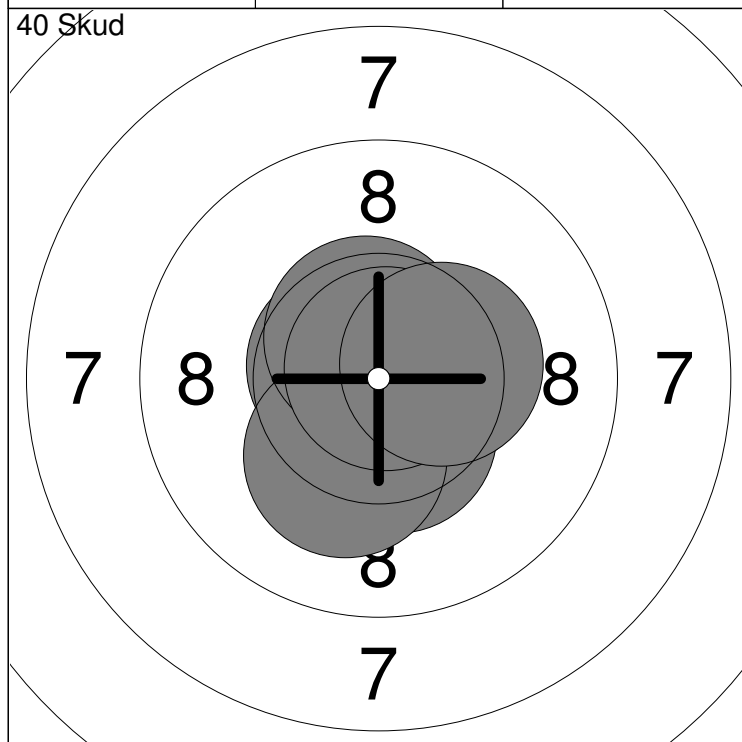

11: 10.7x ↖	16: 10.5x ↘	Serie	105.9
12: 10.5x →	17: 10.2x ↘		
13: 10.8x ↑	18: 10.6x ↗	Total	211.0
14: 10.6x ↘	19: 10.8x ↗		
15: 10.8x →	20: 10.4x →		

21: 10.3x ↖	26: 10.7x ↗	Serie	104.8
22: 10.2x ↗	27: 10.8x ↑		
23: 10.8x →	28: 10.7x ↖	Total	315.8
24: 10.5x ←	29: 10.0 ↙		
25: 10.5x ↑	30: 10.3x ↗		



<p>Prøve</p> <p style="text-align: center;">8 8 8 8 8 8 8 8 8 8</p>	<p>Prøve</p> <p style="text-align: center;">8 8 8 8 8 8 8 8 8 8</p>
<p>1: 10.2 →</p> <p>2: 9.4 ↓</p> <p>3: 10.4x ←</p> <p>4: 9.8 ↑</p> <p>5: 10.1 ↓</p> <p>6: 9.7 →</p> <p>7: 10.7x →</p> <p>8: 10.0 ↓</p> <p>9: 9.8 ↑</p> <p>10: 10.3 →</p>	<p>11: 10.2 →</p> <p>12: 8.8 ←</p> <p>13: 8.5 ←</p> <p>14: 9.8 →</p>
Serie 96.0	Serie 35.0
Total 0.0	Total 0.0

<p>60 Skud</p> <p style="text-align: center;">7 6 7 8 8 8 8 7 7 7 6</p>	<p>60 Skud</p> <p style="text-align: center;">7 8 8 8 8 8 8 8 8 8 7</p>
<p>1: 10.5x ↑</p> <p>2: 9.3 →</p> <p>3: 10.2 →</p> <p>4: 8.8 ↓</p> <p>5: 8.7 ↑</p> <p>6: 10.5x ←</p> <p>7: 6.4 ↑</p> <p>8: 9.6 ↑</p> <p>9: 9.2 ↑</p> <p>10: 9.4 →</p>	<p>11: 9.8 →</p> <p>12: 9.6 ↑</p> <p>13: 10.7x ←</p> <p>14: 9.0 ↑</p> <p>15: 9.3 →</p> <p>16: 9.2 →</p> <p>17: 8.6 ←</p> <p>18: 8.3 ↓</p> <p>19: 10.5x →</p> <p>20: 9.6 ↓</p>
Serie 88.0	Serie 90.0
Total 88.0	Total 178.0

<p>60 Skud</p> <p style="text-align: center;">8 8 8 8 8 8 8 8 8 8 7</p>	<p>60 Skud</p> <p style="text-align: center;">8 8 8 8 8 8 8 8 8 8 8</p>
<p>21: 9.7 →</p> <p>22: 8.5 ←</p> <p>23: 9.9 →</p> <p>24: 10.4x ↗</p> <p>25: 9.7 →</p> <p>26: 10.0 ↑</p> <p>27: 9.2 ↑</p> <p>28: 10.2 ↗</p> <p>29: 9.4 →</p> <p>30: 10.2 ↓</p>	<p>31: 9.3 ↓</p> <p>32: 8.9 ↓</p> <p>33: 10.5x ↑</p> <p>34: 10.1 ↗</p> <p>35: 9.5 →</p> <p>36: 9.5 →</p> <p>37: 10.3 ↘</p> <p>38: 9.8 ↘</p> <p>39: 10.0 ↘</p> <p>40: 9.8 ↑</p>
Serie 93.0	Serie 93.0
Total 271.0	Total 364.0

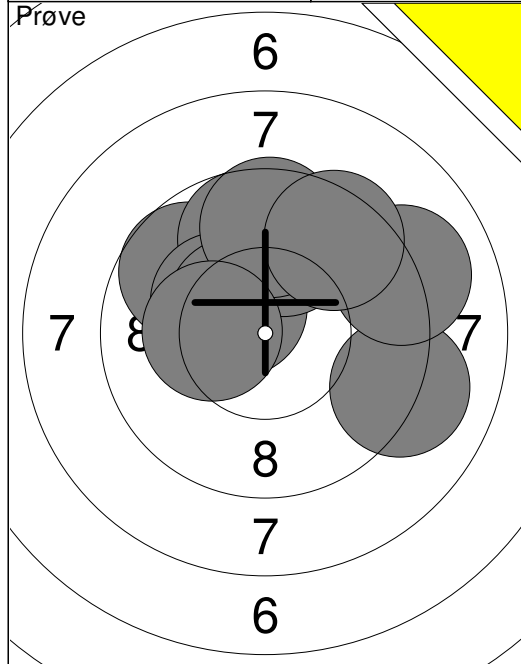

1:	9.1	→
2:	9.7	↖
3:	9.7	↑
4:	9.1	→
5:	10.3x	↖
6:	10.5x	↖
7:	9.8	↑
8:	9.6	↑
9:	10.3x	←
10:	9.5	↗
Serie		97.6
Total		0.0

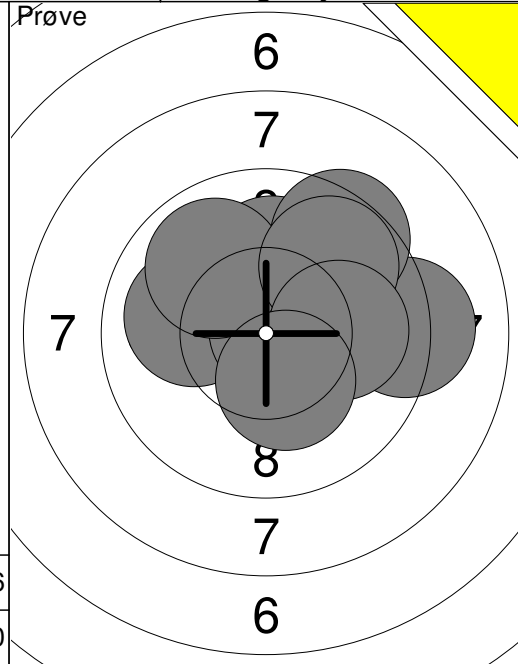

11:	10.0	←
12:	10.1	↑
13:	9.2	→
14:	10.8x	→
15:	9.4	↗
16:	9.9	↖
17:	9.8	↗
18:	10.0	→
19:	10.3x	↓
Serie		89.5
Total		0.0

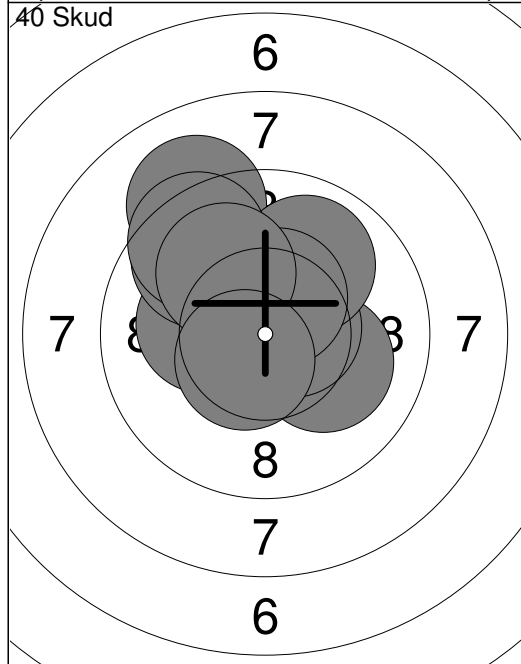

1:	10.1	→
2:	10.6x	→
3:	9.1	↖
4:	9.9	↗
5:	10.2x	←
6:	9.7	↖
7:	10.5x	↗
8:	9.5	↖
9:	10.0	↖
10:	10.5x	↘
Serie		100.1
Total		100.1

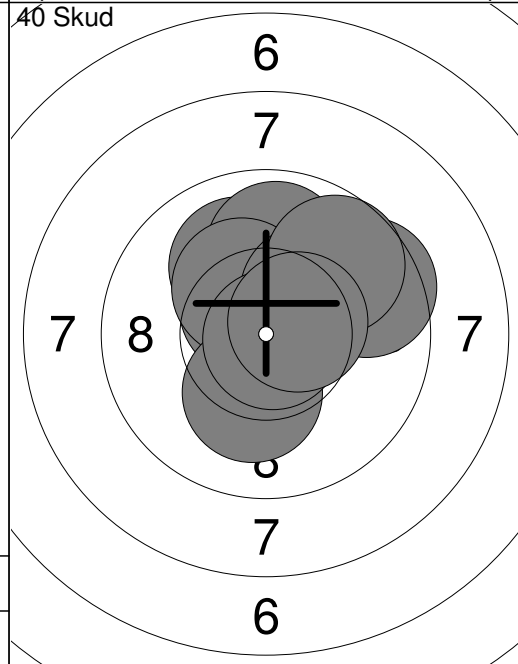

11:	10.0	↖
12:	10.6x	↖
13:	9.9	↑
14:	10.3x	↖
15:	10.2x	↗
16:	9.5	→
17:	10.2x	↓
18:	10.8x	↘
19:	9.7	↗
20:	10.5x	→
Serie		101.7
Total		201.8

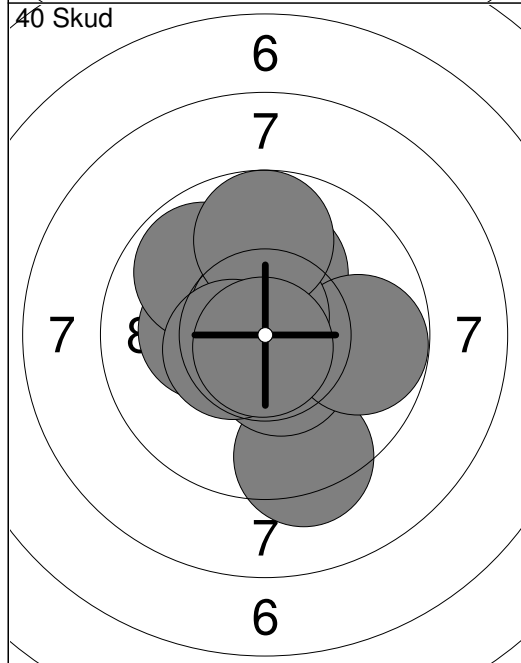

21:	10.2x	←
22:	9.3	↓
23:	10.1	↑
24:	9.8	↖
25:	10.5x	↓
26:	9.8	→
27:	10.7x	↖
28:	9.7	↑
29:	10.5x	←
30:	10.8x	↓
Serie		101.4
Total		303.2

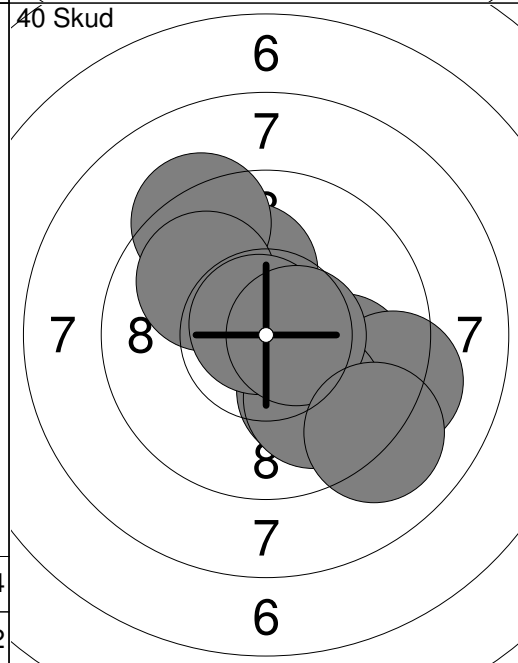

31:	9.9	→
32:	9.2	→
33:	10.1	↓
34:	9.9	↓
35:	10.1	↑
36:	9.3	↖
37:	9.9	↖
38:	10.8x	↖
39:	10.6x	→
40:	9.1	↘
Serie		98.9
Total		402.1

Hold	Skive	Jens Nissen	
5	4		
10m	BPI	HJ	R
	10 meter stævne	Aalborg Skyttekreds	
Prøve		1: 10.4x ↓ 2: 10.2x ↗ 3: 10.7x ↓ 4: 9.9 ↑ 5: 10.3x ↗ 6: 9.2 → 7: 10.8x ↗ 8: 10.2x ↓ 9: 10.6x → 10: 10.7x ↓ Serie 103.0 Total 0.0	Prøve  11: 10.0 → 12: 10.3x ↗ Serie 20.3 Total 0.0
60 Skud		1: 10.3x ↘ 2: 10.7x ↘ 3: 10.2x ↗ 4: 9.4 ↗ 5: 10.4x ↑ 6: 10.1 → 7: 10.6x ↗ 8: 9.3 ↗ 9: 9.7 → 10: 9.5 ↗ Serie 100.2 Total 100.2	60 Skud  11: 9.6 ↗ 12: 10.4x ↓ 13: 9.9 → 14: 8.9 ← 15: 9.6 ↗ 16: 9.7 ↗ 17: 10.5x ↗ 18: 10.0 ↓ 19: 10.2x ↗ 20: 9.6 ← Serie 98.4 Total 198.6
60 Skud		21: 10.5x ↓ 22: 10.5x ← 23: 10.5x ← 24: 9.8 ↓ 25: 9.7 ↗ 26: 10.8x ← 27: 10.2x → 28: 10.3x ↗ 29: 10.2x ← 30: 9.7 ↗ Serie 102.2 Total 300.8	60 Skud  31: 9.3 → 32: 10.2x ↓ 33: 8.6 ↖ 34: 10.1 ↗ 35: 9.7 ← 36: 10.3x → 37: 9.9 ← 38: 10.5x ↑ 39: 10.4x ← 40: 10.4x ↓ Serie 99.4 Total 400.2
60 Skud		41: 8.8 ← 42: 9.4 ↗ 43: 10.1 ↓ 44: 10.9x ↓ 45: 10.7x → 46: 9.7 ↗ 47: 9.9 → 48: 10.5x ↓ 49: 10.9x ← 50: 10.1 ← Serie 101.0 Total 501.2	60 Skud  51: 10.4x ↗ 52: 10.0 ← 53: 9.5 ↓ 54: 9.8 ↑ 55: 9.9 ↖ 56: 9.2 ↓ 57: 9.6 ← 58: 10.4x ← 59: 10.5x ↓ 60: 9.7 ← Serie 99.0 Total 600.2

Prøve 	1: 7.9 ↓ 2: 8.5 ↓ 3: 9.2 ↓ 4: 9.8 → 5: 9.2 ↗ 6: 7.5 ↑ 7: 8.1 ← 8: 10.6x ← 9: 9.6 ↗ 10: 10.1 ↓ <hr/> Serie 90.5 Total 0.0	Prøve 	11: 9.8 ↗ 12: 9.0 ↑ 13: 8.2 ↓ 14: 9.5 ↗ 15: 9.5 ↗ 16: 9.7 ↓ 17: 9.6 ↓ 18: 9.8 → 19: 10.6x ↗ 20: 10.7x ↗ <hr/> Serie 96.4 Total 0.0
-----------	-----------------------------------------------------------------------------------------------------------------------------------------------------------	-----------	---------------------------------------------------------------------------------------------------------------------------------------------------------------------

Prøve 	21: 10.7x ↙ <hr/> Serie 10.7 Total 0.0	40 Skud 	1: 9.6 ↖ 2: 9.7 ← 3: 9.1 ↗ 4: 9.1 ↗ 5: 9.4 ↑ 6: 10.5x ↓ 7: 9.9 ↑ 8: 8.7 ↗ 9: 9.8 ↙ 10: 10.6x ↓ <hr/> Serie 96.4 Total 96.4
-----------	----------------------------------------------	-------------	-------------------------------------------------------------------------------------------------------------------------------------------------------------

40 Skud 	11: 8.8 → 12: 9.8 ↓ 13: 9.3 ↑ 14: 10.5x ↗ 15: 10.5x ↑ 16: 10.1 ↑ 17: 9.1 ↗ 18: 9.9 ↓ 19: 10.0 ← 20: 9.5 ↗ <hr/> Serie 97.5 Total 193.9	40 Skud 	21: 10.4x ↓ 22: 10.6x ↗ 23: 8.7 → 24: 8.9 → 25: 8.7 ↗ 26: 9.4 ↓ 27: 10.7x → 28: 10.3x → 29: 10.1 ↑ 30: 9.8 ↑ <hr/> Serie 97.6 Total 291.5
-------------	-------------------------------------------------------------------------------------------------------------------------------------------------------------------------	-------------	----------------------------------------------------------------------------------------------------------------------------------------------------------------------------

40 Skud 	31: 9.2 ↓ 32: 10.3x ↗ 33: 10.4x ↖ 34: 10.6x ↓ 35: 9.9 ↓ 36: 9.9 → 37: 10.3x ↑ 38: 10.4x ← 39: 10.7x ← 40: 10.3x ↓ <hr/> Serie 102.0 Total 393.5		
-------------	----------------------------------------------------------------------------------------------------------------------------------------------------------------------------------	--	--

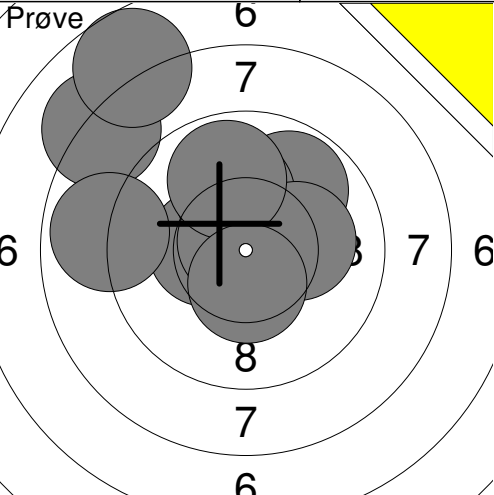
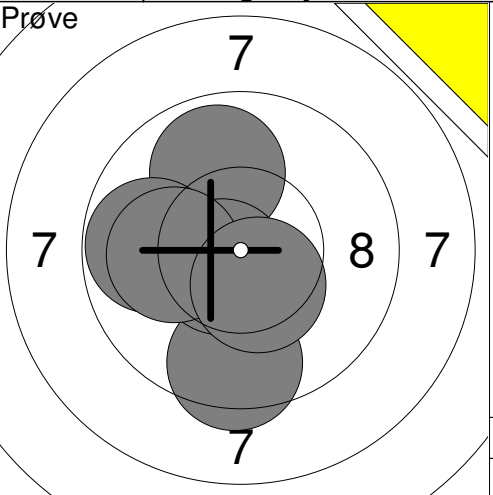
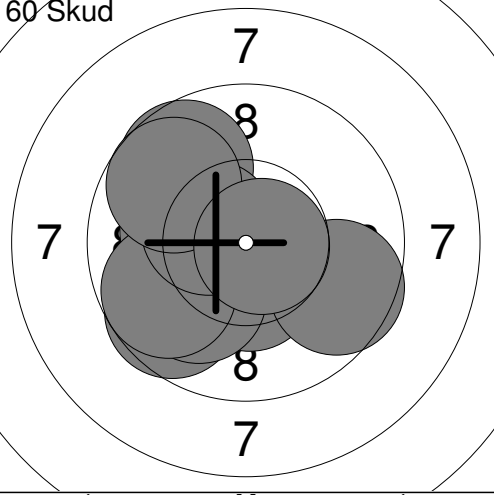
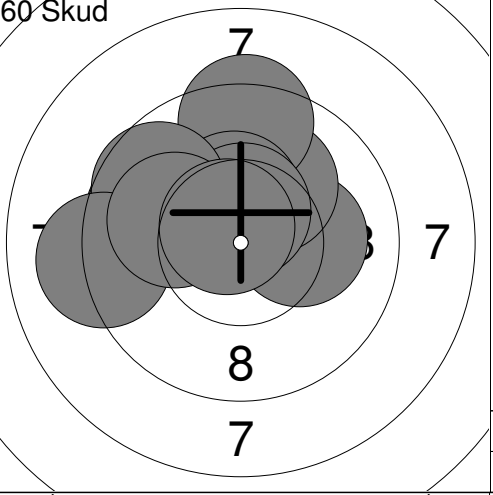
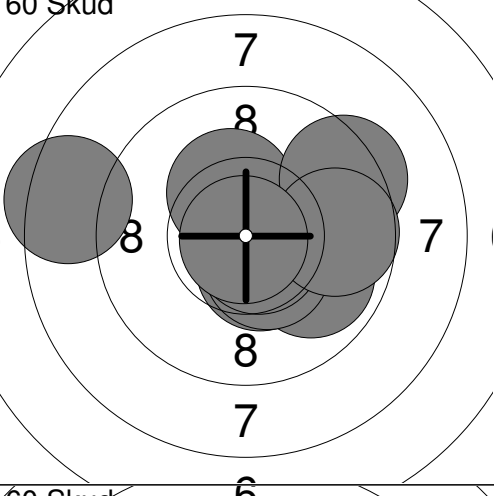
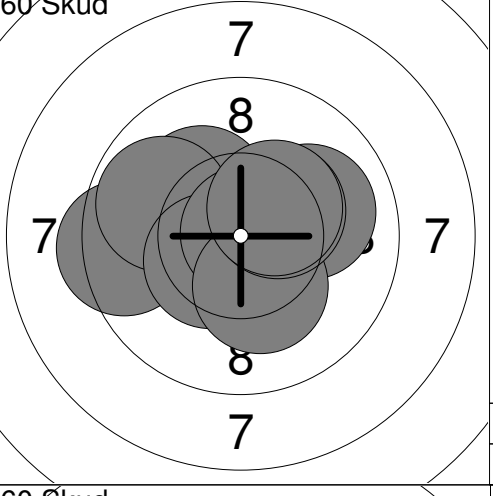
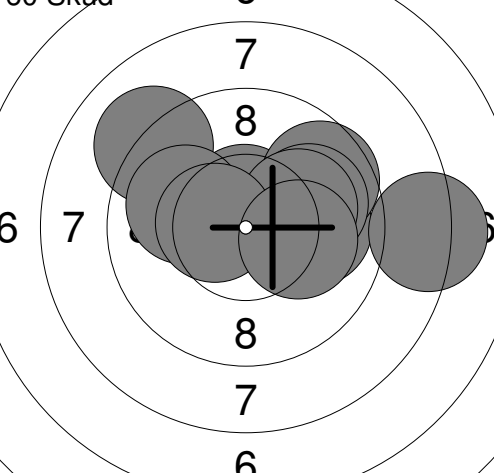
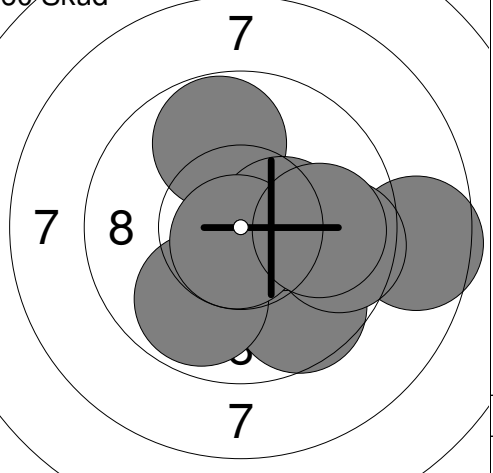
10 meter stævne		Aalborg Skyttekreds	
Prøve 	1: 8.1 ↗ 2: 9.8 ↗ 3: 7.7 ↗ 4: 10.4x ← 5: 10.1 ↑ 6: 10.8x ↗ 7: 8.9 ← 8: 10.2x → 9: 9.9 ↑ 10: 10.4x ↓ Serie 96.3 Total 0.0	Prøve 	11: 9.9 ↑ 12: 9.5 ↓ 13: 10.6x ↙ 14: 9.8 ← 15: 10.1 ← 16: 10.4x ↓ Serie 60.3 Total 0.0
60 Skud 	1: 9.6 ↙ 2: 9.7 ↗ 3: 10.4x ↓ 4: 10.2x ← 5: 10.0 ↙ 6: 9.8 ← 7: 10.4x ↙ 8: 9.6 ↘ 9: 9.7 ↗ 10: 10.7x → Serie 100.1 Total 100.1	60 Skud 	11: 10.2x → 12: 10.1 ↑ 13: 9.4 ↑ 14: 9.7 ← 15: 10.4x ↑ 16: 10.5x ↑ 17: 9.7 ↗ 18: 9.1 ← 19: 10.0 ← 20: 10.7x ↗ Serie 99.8 Total 199.9
60 Skud 	21: 10.7x ↓ 22: 9.9 ↘ 23: 10.5x ↓ 24: 10.4x ↓ 25: 8.4 ← 26: 10.3x ↑ 27: 9.4 ↗ 28: 10.7x ↓ 29: 9.7 → 30: 10.9x ↓ Serie 100.9 Total 300.8	60 Skud 	31: 10.2x ↗ 32: 10.5x ← 33: 9.4 ← 34: 9.9 ← 35: 10.4x ↙ 36: 10.0 → 37: 10.8x → 38: 10.2x ↓ 39: 10.4x ↗ 40: 10.4x ↗ Serie 102.2 Total 403.0
60 Skud 	41: 10.0 → 42: 10.6x ↑ 43: 9.1 ↗ 44: 8.2 → 45: 10.0 ← 46: 9.6 ↗ 47: 9.9 → 48: 10.1 → 49: 10.5x ← 50: 10.1 → Serie 98.1 Total 501.1	60 Skud 	51: 9.9 → 52: 8.6 → 53: 10.2x → 54: 9.8 ↑ 55: 9.6 ↓ 56: 9.6 → 57: 10.4x → 58: 9.9 ↓ 59: 10.8x ↓ 60: 9.9 → Serie 98.7 Total 599.8

Prøve 	1: 10.3x ↑ 2: 10.3x ↓ 3: 10.7x ↓ 4: 10.2x → 5: 10.0 ↓ 6: 9.2 ← 7: 9.7 ← 8: 10.3x ↓ 9: 10.5x ↓ 10: 10.0 ↑ <hr/> Serie 101.2 Total 0.0	Prøve 	11: 9.9 ← 12: 10.2x ↓ 13: 9.3 ← 14: 10.6x → 15: 10.7x ← 16: 9.7 ← 17: 10.3x → 18: 10.5x ↑ 19: 10.7x ↓ <hr/> Serie 91.9 Total 0.0
-----------	-----------------------------------------------------------------------------------------------------------------------------------------------------------------------	-----------	----------------------------------------------------------------------------------------------------------------------------------------------------------------

60 Skud 	1: 10.0 ↗ 2: 9.3 ↗ 3: 10.6x ↑ 4: 10.2x ← 5: 10.6x ← 6: 10.7x ↓ 7: 10.2x ↓ 8: 10.9x ↗ 9: 9.4 → 10: 10.4x → <hr/> Serie 102.3 Total 102.3	60 Skud 	11: 10.7x → 12: 10.4x → 13: 10.2x ↗ 14: 10.5x ↗ 15: 10.4x ↖ 16: 10.4x ↑ 17: 10.5x ↓ 18: 10.3x ↓ 19: 10.6x ← 20: 10.7x ↑ <hr/> Serie 104.7 Total 207.0
-------------	--------------------------------------------------------------------------------------------------------------------------------------------------------------------------	-------------	----------------------------------------------------------------------------------------------------------------------------------------------------------------------------------------

60 Skud 	21: 10.7x ↓ 22: 10.7x ↑ 23: 10.1 ← 24: 10.4x ↗ 25: 9.7 ↗ 26: 10.7x ← 27: 10.8x ↑ 28: 10.0 ↓ 29: 10.4x ↗ 30: 10.6x ↑ <hr/> Serie 104.1 Total 311.1	60 Skud 	31: 10.5x ↓ 32: 10.6x ↖ 33: 9.1 → 34: 10.7x ↖ 35: 10.2x ↓ 36: 9.8 → 37: 9.9 ↘ 38: 10.5x ↓ 39: 10.4x ← 40: 10.4x ↓ <hr/> Serie 102.1 Total 413.2
-------------	------------------------------------------------------------------------------------------------------------------------------------------------------------------------------------	-------------	----------------------------------------------------------------------------------------------------------------------------------------------------------------------------------

60 Skud 	41: 10.0 ↓ 42: 10.3x ↗ 43: 9.7 ← 44: 10.3x ← 45: 10.4x ↑ 46: 10.1 ↑ 47: 10.2x ↖ 48: 10.4x → 49: 10.0 ↗ 50: 10.6x ↗ <hr/> Serie 102.0 Total 515.2	60 Skud 	51: 10.2x ← 52: 9.4 ← 53: 9.9 ← 54: 9.8 ↗ 55: 10.3x → 56: 10.2x ↑ 57: 10.9x ↑ 58: 8.1 ↗ 59: 10.8x ↖ 60: 10.1 ← <hr/> Serie 99.7 Total 614.9
-------------	-----------------------------------------------------------------------------------------------------------------------------------------------------------------------------------	-------------	------------------------------------------------------------------------------------------------------------------------------------------------------------------------------

Prøve 6 	1: 9.3 ↘ 2: 8.9 ← 3: 9.6 ↗ 4: 8.5 → 5: 9.6 → 6: 9.7 → 7: 10.1 ↙ 8: 10.8x ↓ 9: 10.2x ← 10: 7.8 ↖ Serie 94.5 Total 0.0	Prøve 6 	11: 9.4 ↙ 12: 10.9x ↙ 13: 7.9 → 14: 9.4 → Serie 37.6 Total 0.0
-------------	-------------------------------------------------------------------------------------------------------------------------------------------------------	-------------	-------------------------------------------------------------------------------

60 Skud 	1: 9.3 ↘ 2: 10.6x ↓ 3: 9.9 ↑ 4: 9.5 ↑ 5: 10.6x ↓ 6: 9.4 ← 7: 8.3 ↗ 8: 9.9 ↓ 9: 9.7 ↓ 10: 10.4x ↗ Serie 97.6 Total 97.6	60 Skud 	11: 10.5x ← 12: 9.4 ↑ 13: 9.0 ← 14: 10.0 ↓ 15: 9.9 → 16: 10.2x ↓ 17: 8.7 ← 18: 9.4 ← 19: 10.2x ↗ 20: 9.5 ↗ Serie 96.8 Total 194.4
-------------	---------------------------------------------------------------------------------------------------------------------------------------------------------	-------------	--------------------------------------------------------------------------------------------------------------------------------------------------------------------

60 Skud 	21: 9.8 → 22: 9.8 ← 23: 10.1 → 24: 10.3x ↓ 25: 10.4x ↗ 26: 8.4 ↖ 27: 9.9 ← 28: 9.2 ↘ 29: 9.8 ↗ 30: 8.3 ↓ Serie 96.0 Total 290.4	60 Skud 	31: 10.1 ↓ 32: 7.4 ↘ 33: 10.1 ↙ 34: 9.8 → 35: 9.7 ↗ 36: 9.1 → 37: 9.2 ← 38: 10.2x ↓ 39: 9.1 ↙ 40: 9.8 → Serie 94.5 Total 384.9
-------------	------------------------------------------------------------------------------------------------------------------------------------------------------------------	-------------	-----------------------------------------------------------------------------------------------------------------------------------------------------------------

60 Skud 	41: 10.3x ← 42: 8.4 ↗ 43: 9.2 → 44: 10.8x → 45: 10.1 ↓ 46: 10.1 ↓ 47: 9.9 ↑ 48: 10.0 ← 49: 9.6 ↓ 50: 10.3x → Serie 98.7 Total 483.6	60 Skud 	51: 9.0 ↖ 52: 9.9 ↗ 53: 8.9 ← 54: 10.4x ↗ 55: 10.5x → 56: 9.1 ↙ 57: 9.7 ↓ 58: 10.6x ↓ 59: 8.4 ← 60: 10.2x ↗ Serie 96.7 Total 580.3
-------------	----------------------------------------------------------------------------------------------------------------------------------------------------------------------	-------------	---------------------------------------------------------------------------------------------------------------------------------------------------------------------

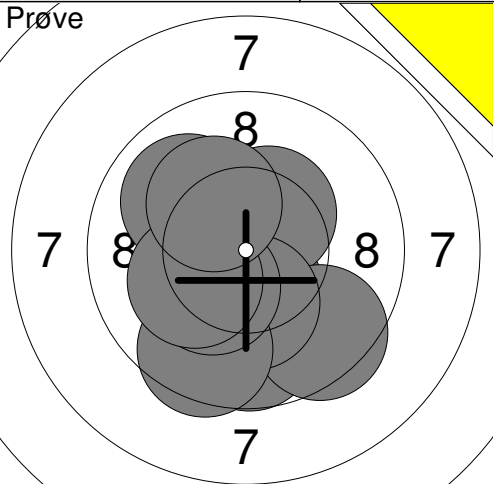
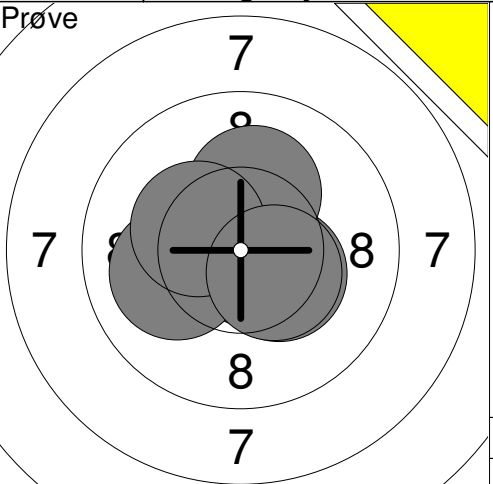
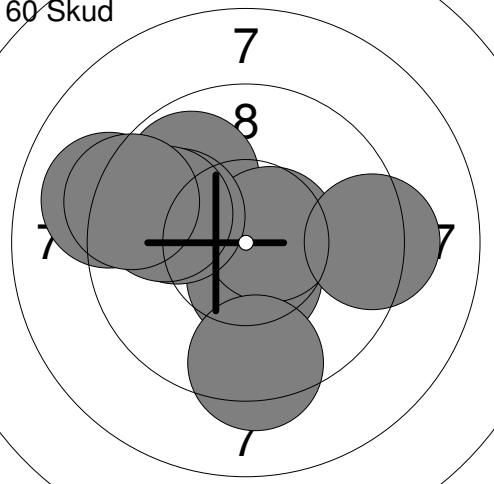
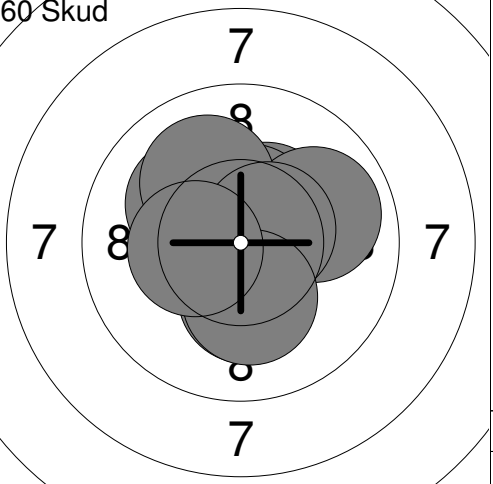
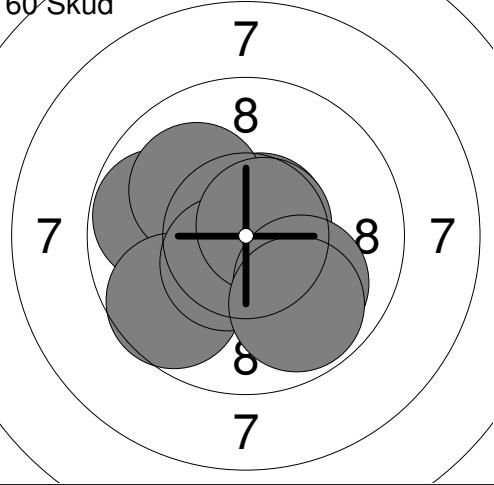
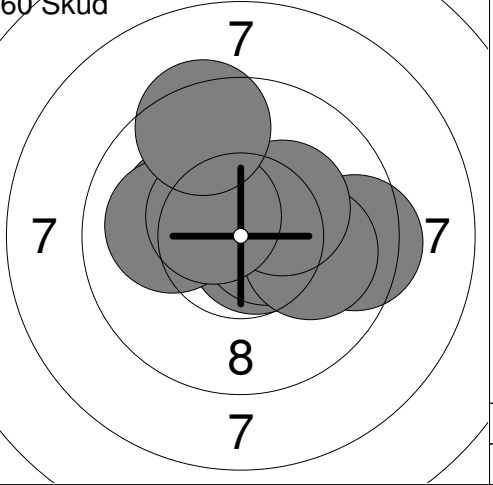
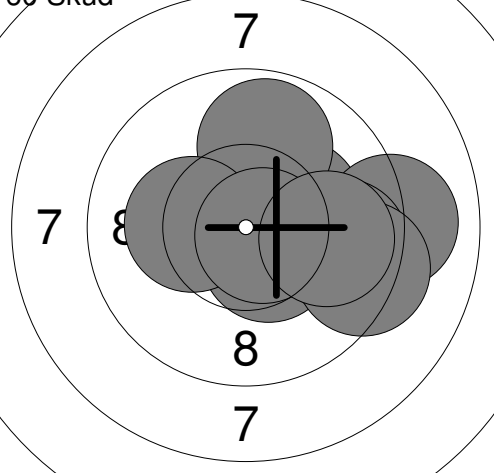
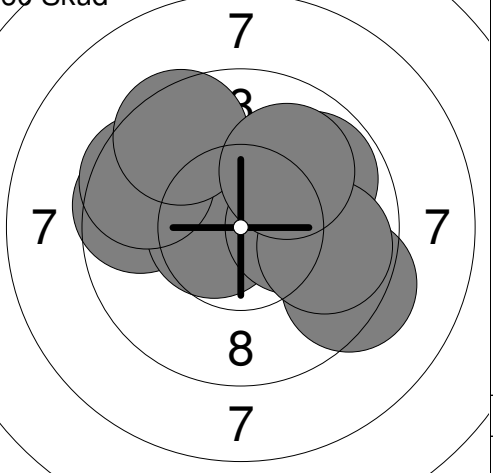
	10 meter stævne	Aalborg Skyttekreds	
Prøve 	1: 9.7 ↓ 2: 10.4x ↓ 3: 10.4x ↗ 4: 9.5 ↓ 5: 10.3x ↓ 6: 9.5 ↓ 7: 10.3x ↘ 8: 10.0 ↗ 9: 10.2x ↙ 10: 10.2x ↗ Serie 100.5 Total 0.0	Prøve 	11: 10.3x ← 12: 10.7x ↘ 13: 10.4x ↘ 14: 10.1 ← 15: 10.2x ↑ 16: 10.3x ↙ 17: 10.4x ↘ Serie 72.4 Total 0.0
60 Skud 	1: 9.9 ↗ 2: 10.5x ↓ 3: 9.1 ← 4: 9.8 ↗ 5: 10.6x → 6: 9.3 → 7: 9.4 ↓ 8: 10.0 ← 9: 9.8 ← 10: 9.4 ← Serie 97.8 Total 97.8	60 Skud 	11: 10.4x ↗ 12: 10.5x ↑ 13: 10.1 ↘ 14: 9.9 → 15: 10.5x ↗ 16: 10.0 ↗ 17: 10.2x ↓ 18: 10.6x → 19: 10.2x ↓ 20: 10.3x ← Serie 102.7 Total 200.5
60 Skud 	21: 10.7x ↗ 22: 10.5x ← 23: 10.6x ↓ 24: 9.8 ← 25: 10.1 ↗ 26: 9.7 ↓ 27: 10.5x ↘ 28: 10.7x → 29: 10.0 ↓ 30: 9.8 ↓ Serie 102.4 Total 302.9	60 Skud 	31: 10.2x ← 32: 10.6x → 33: 10.7x ↘ 34: 10.6x → 35: 9.4 → 36: 10.0 → 37: 10.3x ↗ 38: 10.0 ← 39: 10.5x ↙ 40: 9.4 ↑ Serie 101.7 Total 404.6
60 Skud 	41: 10.5x ↓ 42: 10.3x → 43: 10.3x → 44: 9.8 ↑ 45: 9.0 → 46: 9.7 → 47: 10.2x ← 48: 9.3 → 49: 10.7x ↘ 50: 9.9 → Serie 99.7 Total 504.3	60 Skud 	51: 9.6 ← 52: 10.2x → 53: 9.8 ↗ 54: 10.6x ← 55: 10.3x → 56: 9.3 ↘ 57: 9.8 → 58: 9.6 ↙ 59: 9.5 ↗ 60: 10.0 ↗ Serie 98.7 Total 603.0



Prøve		
	1: 9.9 ↘ 2: 10.6x → 3: 10.0 ↘ 4: 10.0 → 5: 10.8x ↗ 6: 10.7x ↓ 7: 10.3x ↓ 8: 10.7x ↗ 9: 10.5x ↗ 10: 10.5x ↗ <hr/> Serie 104.0 Total 0.0	Prøve
	11: 10.0 ↘ 12: 10.8x ↗ 13: 10.1 ↘ 14: 10.2x ↓ 15: 10.9x ↗ 16: 10.6x ↓ 17: 9.9 ← 18: 10.7x ↗ <hr/> Serie 83.2 Total 0.0	

60 Skud		
	1: 10.8x ↓ 2: 9.9 ← 3: 10.1 ↓ 4: 10.4x → 5: 10.6x ← 6: 10.2x ↗ 7: 10.1 → 8: 9.4 ↘ 9: 10.7x ↘ 10: 10.7x ↓ <hr/> Serie 102.9 Total 102.9	60 Skud
	11: 10.8x ↙ 12: 10.3x ↗ 13: 10.2x ↖ 14: 9.8 ↘ 15: 10.4x ↓ 16: 10.2x ↖ 17: 10.0 ↓ 18: 10.3x ↓ 19: 10.7x ↙ 20: 10.4x ↙ <hr/> Serie 103.1 Total 206.0	

60 Skud		
	21: 10.2x ↗ 22: 9.8 ↗ 23: 10.9x ↗ 24: 10.7x ↗ 25: 10.6x ↓ 26: 10.5x ↗ 27: 10.4x → 28: 9.8 ↗ 29: 10.6x → 30: 10.4x ← <hr/> Serie 103.9 Total 309.9	60 Skud
	31: 10.8x ↗ 32: 10.4x ↗ 33: 10.5x ↙ 34: 10.5x ↗ 35: 10.0 ← 36: 10.3x → 37: 9.8 ← 38: 9.2 ↓ 39: 10.1 → 40: 10.5x ↓ <hr/> Serie 102.1 Total 412.0	

60 Skud		
	41: 10.5x ↓ 42: 10.5x → 43: 9.6 ↘ 44: 10.2x ↓ 45: 10.4x ↓ 46: 10.4x ← 47: 10.4x ↖ 48: 10.2x ↗ 49: 9.9 ↘ 50: 10.7x ↗ <hr/> Serie 102.8 Total 514.8	60 Skud
	51: 10.4x ↘ 52: 10.4x ↓ 53: 10.5x ↗ 54: 9.2 ↘ 55: 10.1 ↗ 56: 9.4 ↓ 57: 10.3x ↗ 58: 10.2x ← 59: 10.2x ↓ 60: 9.8 ↘ <hr/> Serie 100.5 Total 615.3	

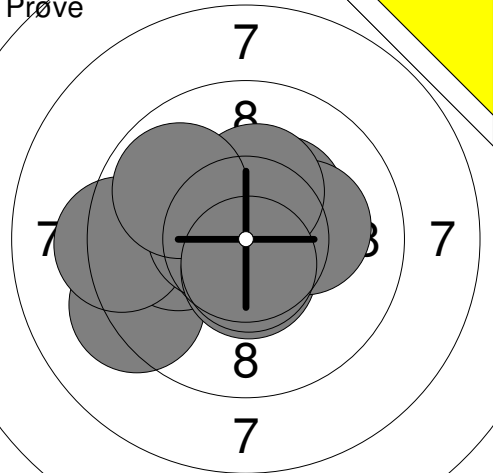
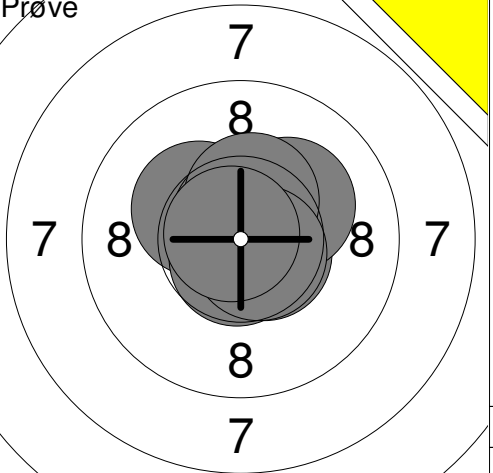
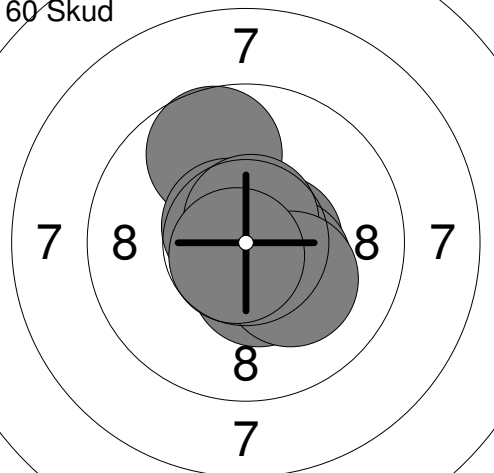
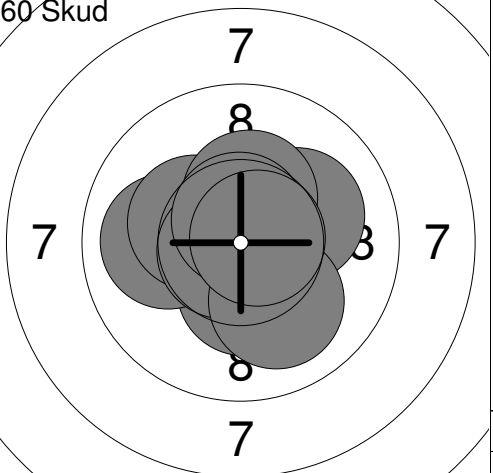
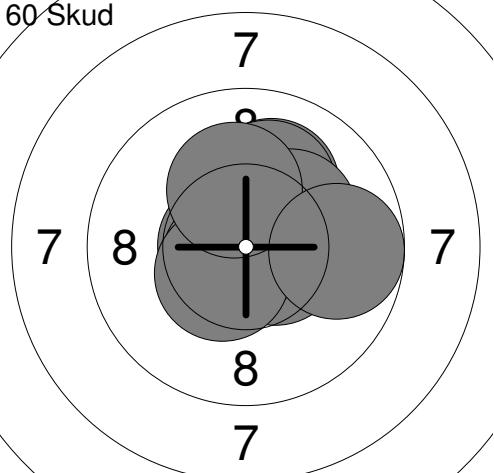
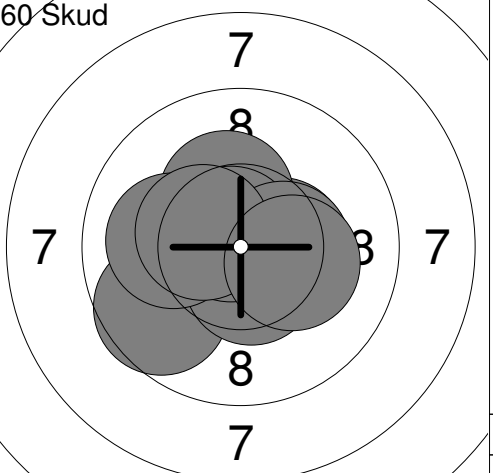
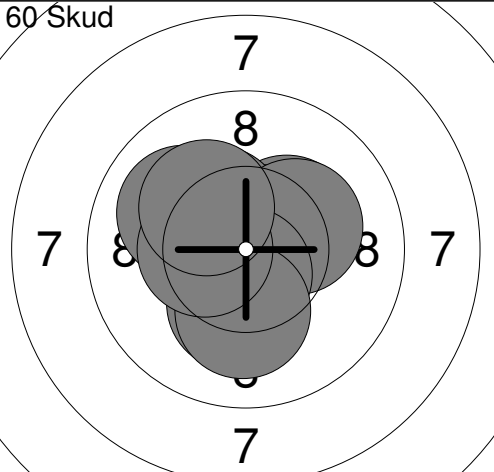
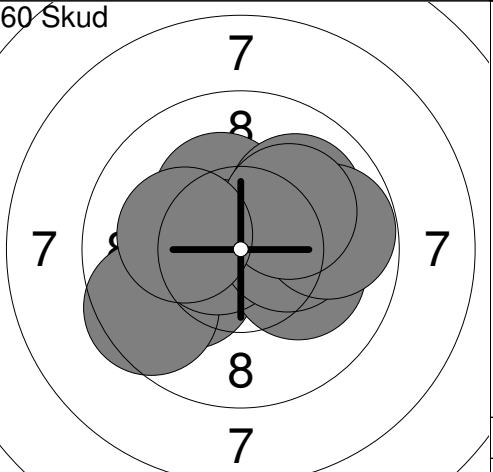
	10 meter stævne	Aalborg Skyttekreds	
Prøve 	1: 9.3 ↙ 2: 10.1 ← 3: 9.3 ← 4: 10.5x ← 5: 10.3x ↗ 6: 10.5x ↓ 7: 10.2x → 8: 10.3x ↑ 9: 9.9 ↖ 10: 10.6x ↓ <hr/> Serie 101.0 Total 0.0	Prøve 	11: 10.3x ↖ 12: 10.6x → 13: 10.7x ↑ 14: 10.7x ↓ 15: 10.2x ↗ 16: 10.4x ↑ 17: 10.6x → 18: 10.8x ↖ <hr/> Serie 84.3 Total 0.0
60 Skud 	1: 10.4x ↓ 2: 9.7 ↑ 3: 10.7x ↓ 4: 10.6x → 5: 10.6x → 6: 10.6x ↗ 7: 10.4x → 8: 10.7x ↑ 9: 10.2x ↓ 10: 10.7x ↓ <hr/> Serie 104.6 Total 104.6	60 Skud 	11: 10.7x ↖ 12: 10.4x ↓ 13: 10.0 ← 14: 10.3x ↖ 15: 10.1 → 16: 10.7x ↖ 17: 10.3x ↑ 18: 10.6x ↑ 19: 10.1 ↓ 20: 10.7x → <hr/> Serie 103.9 Total 208.5
60 Skud 	21: 10.1 ↑ 22: 10.7x ← 23: 10.5x → 24: 10.4x ↗ 25: 10.1 ↑ 26: 10.2x ↗ 27: 10.7x ↖ 28: 10.5x ↖ 29: 10.2x ↑ 30: 9.7 → <hr/> Serie 103.1 Total 311.6	60 Skud 	31: 10.6x → 32: 9.6 ↖ 33: 10.5x ↓ 34: 10.4x → 35: 10.3x ↑ 36: 10.1 ← 37: 10.7x ↗ 38: 10.4x → 39: 10.4x ↖ 40: 10.2x → <hr/> Serie 103.2 Total 414.8
60 Skud 	41: 10.2x ↓ 42: 10.3x ↗ 43: 10.0 ↖ 44: 10.6x ↗ 45: 10.3x ↖ 46: 10.2x ↗ 47: 10.6x ↓ 48: 10.1 ↓ 49: 10.4x ← 50: 10.2x ↖ <hr/> Serie 102.9 Total 517.7	60 Skud 	51: 10.2x ↖ 52: 10.1 ↖ 53: 9.5 ↖ 54: 10.0 ↗ 55: 10.1 → 56: 10.6x ← 57: 10.3x → 58: 9.8 → 59: 10.1 ↗ 60: 10.2x ← <hr/> Serie 100.9 Total 618.6

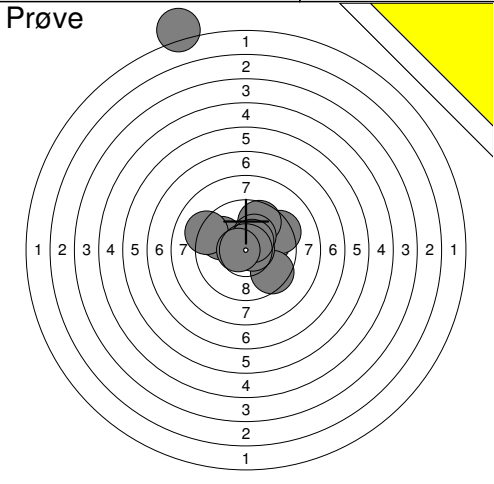
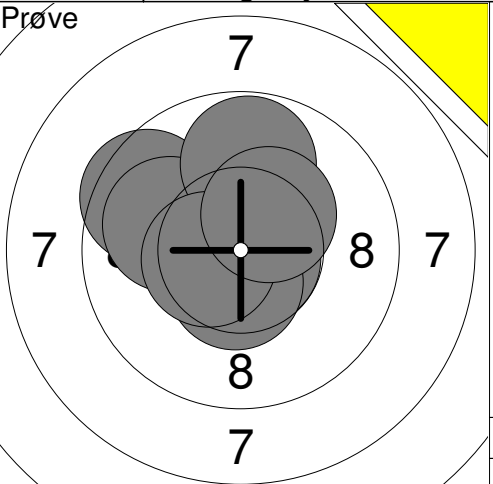
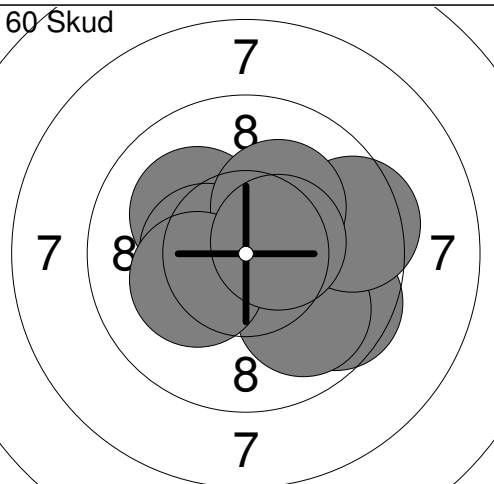
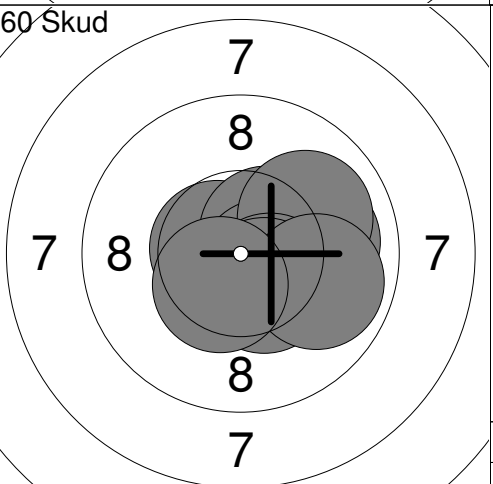
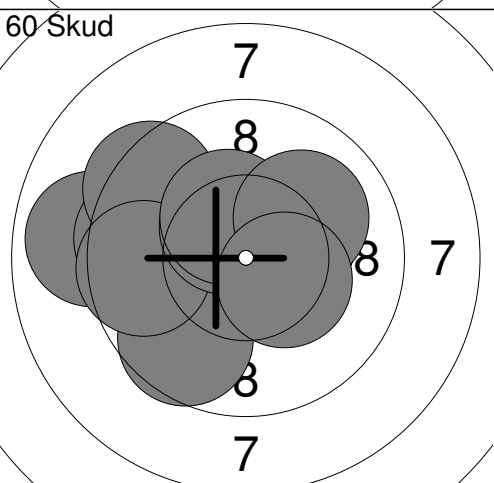
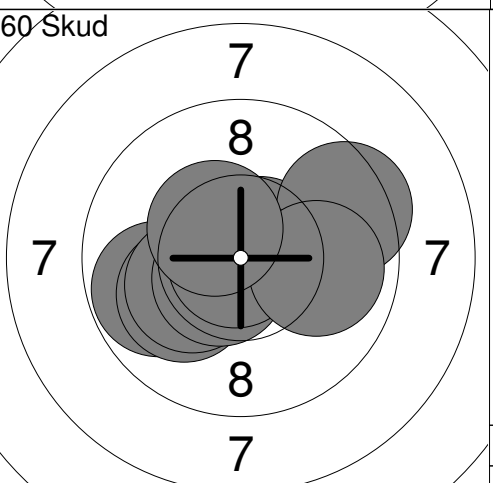
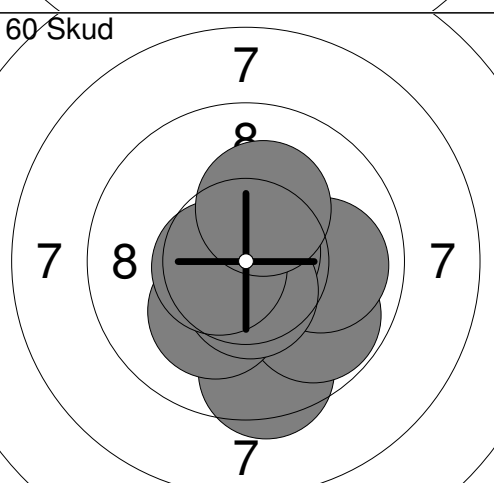
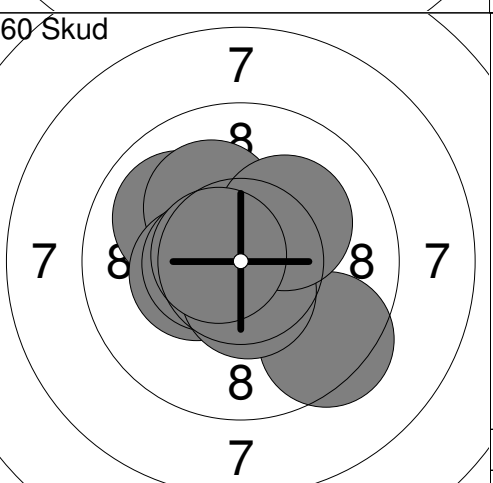
Hold	Skive	Nanna Bissø	
6	3		
10m	ÅRK	D	R
10 meter stævne		Aalborg Skyttekreds	
Prøve		1: 9.4 ↗ 2: 9.5 ↘ 3: 9.7 ↗ 4: 9.8 ↖ 5: 10.3x ↗ 6: 10.7x → 7: 9.2 ↖ 8: 10.5x ↗ 9: 1.4 ↑ 10: 10.6x ← Serie 91.1 Total 0.0	Prøve  11: 10.8x ↖ 12: 10.8x → 13: 9.5 ↖ 14: 10.5x ↓ 15: 10.0 ← 16: 9.8 ↑ 17: 10.5x ← 18: 10.4x ↗ Serie 82.3 Total 0.0
60 Skud		1: 10.7x ← 2: 10.1 ↗ 3: 9.9 ↘ 4: 9.6 ↘ 5: 9.9 ↘ 6: 10.4x ← 7: 9.5 → 8: 10.2x ↗ 9: 10.2x ← 10: 10.5x → Serie 101.0 Total 101.0	60 Skud  11: 10.1 → 12: 10.6x ← 13: 10.5x ↗ 14: 10.6x → 15: 10.0 → 16: 10.0 ↗ 17: 10.4x ↘ 18: 10.4x ↘ 19: 9.9 → 20: 10.5x ↘ Serie 103.0 Total 204.0
60 Skud		21: 8.9 ← 22: 10.3x → 23: 9.5 ← 24: 9.4 ↗ 25: 9.6 ↘ 26: 9.6 ← 27: 10.5x ↗ 28: 10.4x ↗ 29: 10.1 ↗ 30: 10.4x → Serie 98.7 Total 302.7	60 Skud  31: 9.8 ← 32: 10.6x ↗ 33: 10.1 ← 34: 10.9x ↘ 35: 10.2x ← 36: 10.6x ↘ 37: 9.4 → 38: 10.9x ← 39: 9.9 → 40: 10.4x ↖ Serie 102.8 Total 405.5
60 Skud		41: 10.0 → 42: 9.5 ↓ 43: 10.9x ↗ 44: 9.8 ↘ 45: 10.0 → 46: 10.8x ↗ 47: 10.2x ↘ 48: 10.6x ↓ 49: 10.6x ← 50: 10.2x ↗ Serie 102.6 Total 508.1	60 Skud  51: 10.0 ↖ 52: 10.6x ↗ 53: 10.1 ↗ 54: 10.4x ← 55: 10.5x ← 56: 10.7x → 57: 9.4 ↘ 58: 10.5x ↓ 59: 10.2x ↗ 60: 10.6x ← Serie 103.0 Total 611.1

Hold	Skive	Niels H. Overgaard			
6	4				
10m	BPI	H	R		
	10 meter stævne	Aalborg Skyttekreds			
Prøve		1: 9.2 ↓	Prøve		11: 10.0 ←
		2: 10.2x ↓			12: 9.8 ←
		3: 10.2x ↓			13: 10.0 ←
		4: 9.3 ↓		14: 10.2x →	
		5: 9.9 ←		15: 10.5x ↓	
		6: 10.4x →		16: 10.9x ↗	
		7: 9.2 ←			
		8: 10.8x ←			
		9: 10.5x ↓			
		10: 9.9 ↓			
		Serie 99.6		Serie 61.4	
		Total 0.0		Total 0.0	
60 Skud		1: 9.9 ↑	60 Skud		11: 10.4x ↓
		2: 10.6x →			12: 10.3x ←
		3: 10.4x →			13: 10.2x →
		4: 10.4x ↑		14: 10.6x ↗	
		5: 10.2x ↓		15: 10.5x ←	
		6: 10.0 ↗		16: 10.0 ↗	
		7: 10.2x ↑		17: 10.3x ←	
		8: 10.8x ↓		18: 10.2x ↓	
		9: 10.2x →		19: 10.6x ↑	
		10: 9.7 →		20: 10.6x ↓	
		Serie 102.4		Serie 103.7	
		Total 102.4		Total 206.1	
60 Skud		21: 10.5x ↗	60 Skud		31: 10.0 ←
		22: 10.3x ↑			32: 10.7x →
		23: 10.4x ↓			33: 10.6x ↓
		24: 10.3x ↗		34: 10.7x ↓	
		25: 10.0 ↗		35: 10.3x →	
		26: 10.5x ↗		36: 10.1 ↗	
		27: 10.6x ↓		37: 10.3x ←	
		28: 10.3x →		38: 10.3x ←	
		29: 9.8 ↑		39: 9.7 →	
		30: 9.7 ↗		40: 10.4x →	
		Serie 102.4		Serie 103.1	
		Total 308.5		Total 411.6	
60 Skud		41: 10.3x ←	60 Skud		51: 10.8x →
		42: 10.9x ↓			52: 10.0 ↑
		43: 10.5x ↓			53: 10.4x ↓
		44: 10.2x →		54: 10.3x ↗	
		45: 10.3x ↑		55: 10.2x ←	
		46: 10.3x ↑		56: 10.0 ←	
		47: 10.3x →		57: 9.5 ←	
		48: 9.9 ↓		58: 10.2x →	
		49: 9.8 ↓		59: 10.6x ↑	
		50: 10.1 ↓		60: 10.3x ↗	
		Serie 102.6		Serie 102.3	
		Total 514.2		Total 616.5	

	10 meter stævne	Aalborg Skyttekreds
--	-----------------	---------------------

Prøve		Prøve																																																																									
	<table border="1" style="width:100%; border-collapse: collapse;"> <tr><td>1:</td><td>10.1</td><td>→</td></tr> <tr><td>2:</td><td>10.1</td><td>↘</td></tr> <tr><td>3:</td><td>10.3x</td><td>↘</td></tr> <tr><td>4:</td><td>9.3</td><td>↘</td></tr> <tr><td>5:</td><td>9.3</td><td>←</td></tr> <tr><td>6:</td><td>0.0</td><td>↑</td></tr> <tr><td>7:</td><td>8.8</td><td>←</td></tr> <tr><td>8:</td><td>10.3x</td><td>←</td></tr> <tr><td>9:</td><td>10.6x</td><td>←</td></tr> <tr><td>10:</td><td>10.6x</td><td>↓</td></tr> <tr><td colspan="2">Serie</td><td>89.4</td></tr> <tr><td colspan="2">Total</td><td>0.0</td></tr> </table>	1:	10.1	→	2:	10.1	↘	3:	10.3x	↘	4:	9.3	↘	5:	9.3	←	6:	0.0	↑	7:	8.8	←	8:	10.3x	←	9:	10.6x	←	10:	10.6x	↓	Serie		89.4	Total		0.0		<table border="1" style="width:100%; border-collapse: collapse;"> <tr><td>11:</td><td>10.2x</td><td>→</td></tr> <tr><td>12:</td><td>9.6</td><td>↘</td></tr> <tr><td>13:</td><td>10.2x</td><td>↘</td></tr> <tr><td>14:</td><td>10.1</td><td>←</td></tr> <tr><td>15:</td><td>10.2x</td><td>↘</td></tr> <tr><td>16:</td><td>9.7</td><td>→</td></tr> <tr><td>17:</td><td>10.3x</td><td>→</td></tr> <tr><td>18:</td><td>9.5</td><td>→</td></tr> <tr><td>19:</td><td>10.3x</td><td>↗</td></tr> <tr><td>20:</td><td>10.4x</td><td>↗</td></tr> <tr><td colspan="2">Serie</td><td>100.5</td></tr> <tr><td colspan="2">Total</td><td>0.0</td></tr> </table>	11:	10.2x	→	12:	9.6	↘	13:	10.2x	↘	14:	10.1	←	15:	10.2x	↘	16:	9.7	→	17:	10.3x	→	18:	9.5	→	19:	10.3x	↗	20:	10.4x	↗	Serie		100.5	Total		0.0
1:	10.1	→																																																																									
2:	10.1	↘																																																																									
3:	10.3x	↘																																																																									
4:	9.3	↘																																																																									
5:	9.3	←																																																																									
6:	0.0	↑																																																																									
7:	8.8	←																																																																									
8:	10.3x	←																																																																									
9:	10.6x	←																																																																									
10:	10.6x	↓																																																																									
Serie		89.4																																																																									
Total		0.0																																																																									
11:	10.2x	→																																																																									
12:	9.6	↘																																																																									
13:	10.2x	↘																																																																									
14:	10.1	←																																																																									
15:	10.2x	↘																																																																									
16:	9.7	→																																																																									
17:	10.3x	→																																																																									
18:	9.5	→																																																																									
19:	10.3x	↗																																																																									
20:	10.4x	↗																																																																									
Serie		100.5																																																																									
Total		0.0																																																																									

Prøve		60 Skud																																														
	<table border="1" style="width:100%; border-collapse: collapse;"> <tr><td>21:</td><td>10.2x</td><td>←</td></tr> <tr><td colspan="2">Serie</td><td>10.2</td></tr> <tr><td colspan="2">Total</td><td>0.0</td></tr> </table>	21:	10.2x	←	Serie		10.2	Total		0.0		<table border="1" style="width:100%; border-collapse: collapse;"> <tr><td>1:</td><td>9.5</td><td>↗</td></tr> <tr><td>2:</td><td>9.9</td><td>←</td></tr> <tr><td>3:</td><td>10.0</td><td>↗</td></tr> <tr><td>4:</td><td>10.2x</td><td>↗</td></tr> <tr><td>5:</td><td>10.3x</td><td>↘</td></tr> <tr><td>6:</td><td>10.3x</td><td>↘</td></tr> <tr><td>7:</td><td>10.2x</td><td>↗</td></tr> <tr><td>8:</td><td>10.5x</td><td>↗</td></tr> <tr><td>9:</td><td>10.1</td><td>↗</td></tr> <tr><td>10:</td><td>10.4x</td><td>→</td></tr> <tr><td colspan="2">Serie</td><td>101.4</td></tr> <tr><td colspan="2">Total</td><td>101.4</td></tr> </table>	1:	9.5	↗	2:	9.9	←	3:	10.0	↗	4:	10.2x	↗	5:	10.3x	↘	6:	10.3x	↘	7:	10.2x	↗	8:	10.5x	↗	9:	10.1	↗	10:	10.4x	→	Serie		101.4	Total		101.4
21:	10.2x	←																																														
Serie		10.2																																														
Total		0.0																																														
1:	9.5	↗																																														
2:	9.9	←																																														
3:	10.0	↗																																														
4:	10.2x	↗																																														
5:	10.3x	↘																																														
6:	10.3x	↘																																														
7:	10.2x	↗																																														
8:	10.5x	↗																																														
9:	10.1	↗																																														
10:	10.4x	→																																														
Serie		101.4																																														
Total		101.4																																														

60 Skud		60 Skud																																																																									
	<table border="1" style="width:100%; border-collapse: collapse;"> <tr><td>11:</td><td>9.4</td><td>↘</td></tr> <tr><td>12:</td><td>9.9</td><td>↗</td></tr> <tr><td>13:</td><td>10.1</td><td>↗</td></tr> <tr><td>14:</td><td>9.6</td><td>→</td></tr> <tr><td>15:</td><td>10.0</td><td>→</td></tr> <tr><td>16:</td><td>10.1</td><td>←</td></tr> <tr><td>17:</td><td>10.3x</td><td>←</td></tr> <tr><td>18:</td><td>10.0</td><td>↗</td></tr> <tr><td>19:</td><td>9.7</td><td>→</td></tr> <tr><td>20:</td><td>10.3x</td><td>↗</td></tr> <tr><td colspan="2">Serie</td><td>99.4</td></tr> <tr><td colspan="2">Total</td><td>200.8</td></tr> </table>	11:	9.4	↘	12:	9.9	↗	13:	10.1	↗	14:	9.6	→	15:	10.0	→	16:	10.1	←	17:	10.3x	←	18:	10.0	↗	19:	9.7	→	20:	10.3x	↗	Serie		99.4	Total		200.8		<table border="1" style="width:100%; border-collapse: collapse;"> <tr><td>21:</td><td>10.6x</td><td>↑</td></tr> <tr><td>22:</td><td>10.1</td><td>↘</td></tr> <tr><td>23:</td><td>10.3x</td><td>↗</td></tr> <tr><td>24:</td><td>10.3x</td><td>→</td></tr> <tr><td>25:</td><td>10.0</td><td>↘</td></tr> <tr><td>26:</td><td>10.6x</td><td>↘</td></tr> <tr><td>27:</td><td>10.4x</td><td>↘</td></tr> <tr><td>28:</td><td>10.4x</td><td>↗</td></tr> <tr><td>29:</td><td>10.6x</td><td>→</td></tr> <tr><td>30:</td><td>10.5x</td><td>→</td></tr> <tr><td colspan="2">Serie</td><td>103.8</td></tr> <tr><td colspan="2">Total</td><td>304.6</td></tr> </table>	21:	10.6x	↑	22:	10.1	↘	23:	10.3x	↗	24:	10.3x	→	25:	10.0	↘	26:	10.6x	↘	27:	10.4x	↘	28:	10.4x	↗	29:	10.6x	→	30:	10.5x	→	Serie		103.8	Total		304.6
11:	9.4	↘																																																																									
12:	9.9	↗																																																																									
13:	10.1	↗																																																																									
14:	9.6	→																																																																									
15:	10.0	→																																																																									
16:	10.1	←																																																																									
17:	10.3x	←																																																																									
18:	10.0	↗																																																																									
19:	9.7	→																																																																									
20:	10.3x	↗																																																																									
Serie		99.4																																																																									
Total		200.8																																																																									
21:	10.6x	↑																																																																									
22:	10.1	↘																																																																									
23:	10.3x	↗																																																																									
24:	10.3x	→																																																																									
25:	10.0	↘																																																																									
26:	10.6x	↘																																																																									
27:	10.4x	↘																																																																									
28:	10.4x	↗																																																																									
29:	10.6x	→																																																																									
30:	10.5x	→																																																																									
Serie		103.8																																																																									
Total		304.6																																																																									

60 Skud		60 Skud																																																																									
	<table border="1" style="width:100%; border-collapse: collapse;"> <tr><td>31:</td><td>10.9x</td><td>↗</td></tr> <tr><td>32:</td><td>10.4x</td><td>↗</td></tr> <tr><td>33:</td><td>10.2x</td><td>→</td></tr> <tr><td>34:</td><td>9.9</td><td>←</td></tr> <tr><td>35:</td><td>10.3x</td><td>↗</td></tr> <tr><td>36:</td><td>10.7x</td><td>↗</td></tr> <tr><td>37:</td><td>9.7</td><td>←</td></tr> <tr><td>38:</td><td>9.8</td><td>→</td></tr> <tr><td>39:</td><td>10.6x</td><td>↘</td></tr> <tr><td>40:</td><td>10.3x</td><td>↑</td></tr> <tr><td colspan="2">Serie</td><td>102.8</td></tr> <tr><td colspan="2">Total</td><td>407.4</td></tr> </table>	31:	10.9x	↗	32:	10.4x	↗	33:	10.2x	→	34:	9.9	←	35:	10.3x	↗	36:	10.7x	↗	37:	9.7	←	38:	9.8	→	39:	10.6x	↘	40:	10.3x	↑	Serie		102.8	Total		407.4		<table border="1" style="width:100%; border-collapse: collapse;"> <tr><td>41:</td><td>9.7</td><td>↖</td></tr> <tr><td>42:</td><td>9.9</td><td>↑</td></tr> <tr><td>43:</td><td>10.5x</td><td>↑</td></tr> <tr><td>44:</td><td>10.7x</td><td>→</td></tr> <tr><td>45:</td><td>10.3x</td><td>↑</td></tr> <tr><td>46:</td><td>10.8x</td><td>←</td></tr> <tr><td>47:</td><td>10.5x</td><td>↗</td></tr> <tr><td>48:</td><td>9.8</td><td>↗</td></tr> <tr><td>49:</td><td>10.5x</td><td>↗</td></tr> <tr><td>50:</td><td>10.8x</td><td>↓</td></tr> <tr><td colspan="2">Serie</td><td>103.5</td></tr> <tr><td colspan="2">Total</td><td>510.9</td></tr> </table>	41:	9.7	↖	42:	9.9	↑	43:	10.5x	↑	44:	10.7x	→	45:	10.3x	↑	46:	10.8x	←	47:	10.5x	↗	48:	9.8	↗	49:	10.5x	↗	50:	10.8x	↓	Serie		103.5	Total		510.9
31:	10.9x	↗																																																																									
32:	10.4x	↗																																																																									
33:	10.2x	→																																																																									
34:	9.9	←																																																																									
35:	10.3x	↗																																																																									
36:	10.7x	↗																																																																									
37:	9.7	←																																																																									
38:	9.8	→																																																																									
39:	10.6x	↘																																																																									
40:	10.3x	↑																																																																									
Serie		102.8																																																																									
Total		407.4																																																																									
41:	9.7	↖																																																																									
42:	9.9	↑																																																																									
43:	10.5x	↑																																																																									
44:	10.7x	→																																																																									
45:	10.3x	↑																																																																									
46:	10.8x	←																																																																									
47:	10.5x	↗																																																																									
48:	9.8	↗																																																																									
49:	10.5x	↗																																																																									
50:	10.8x	↓																																																																									
Serie		103.5																																																																									
Total		510.9																																																																									

60 Skud																																							
	<table border="1" style="width:100%; border-collapse: collapse;"> <tr><td>51:</td><td>10.5x</td><td>↘</td></tr> <tr><td>52:</td><td>10.7x</td><td>←</td></tr> <tr><td>53:</td><td>10.3x</td><td>←</td></tr> <tr><td>54:</td><td>9.0</td><td>→</td></tr> <tr><td>55:</td><td>9.5</td><td>↖</td></tr> <tr><td>56:</td><td>10.0</td><td>↘</td></tr> <tr><td>57:</td><td>9.7</td><td>←</td></tr> <tr><td>58:</td><td>10.7x</td><td>↗</td></tr> <tr><td>59:</td><td>8.9</td><td>←</td></tr> <tr><td>60:</td><td>10.4x</td><td>↓</td></tr> <tr><td colspan="2">Serie</td><td>99.7</td></tr> <tr><td colspan="2">Total</td><td>610.6</td></tr> </table>	51:	10.5x	↘	52:	10.7x	←	53:	10.3x	←	54:	9.0	→	55:	9.5	↖	56:	10.0	↘	57:	9.7	←	58:	10.7x	↗	59:	8.9	←	60:	10.4x	↓	Serie		99.7	Total		610.6		
51:	10.5x	↘																																					
52:	10.7x	←																																					
53:	10.3x	←																																					
54:	9.0	→																																					
55:	9.5	↖																																					
56:	10.0	↘																																					
57:	9.7	←																																					
58:	10.7x	↗																																					
59:	8.9	←																																					
60:	10.4x	↓																																					
Serie		99.7																																					
Total		610.6																																					

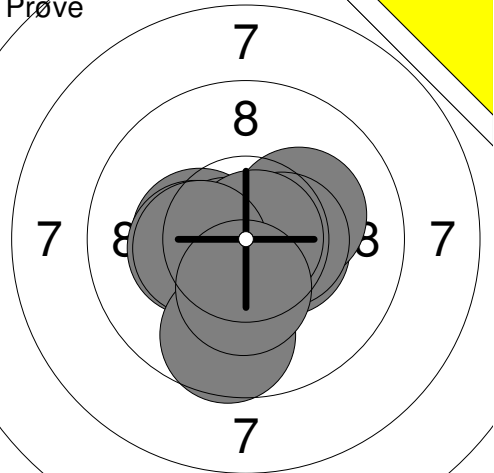
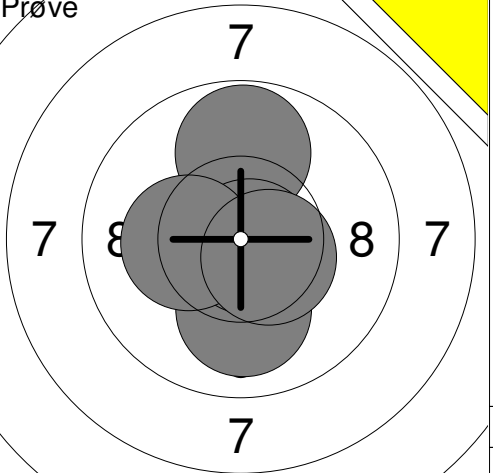
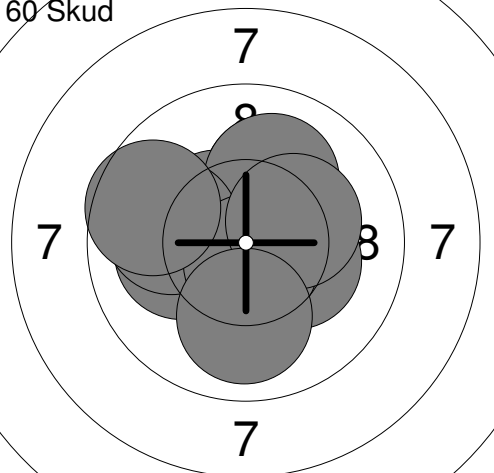
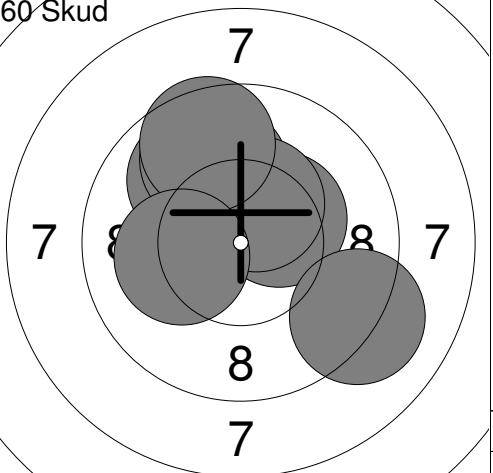
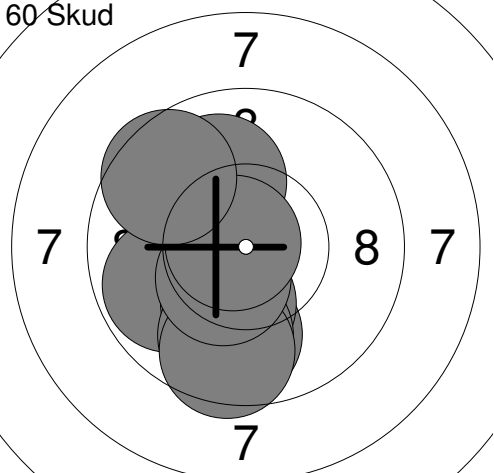
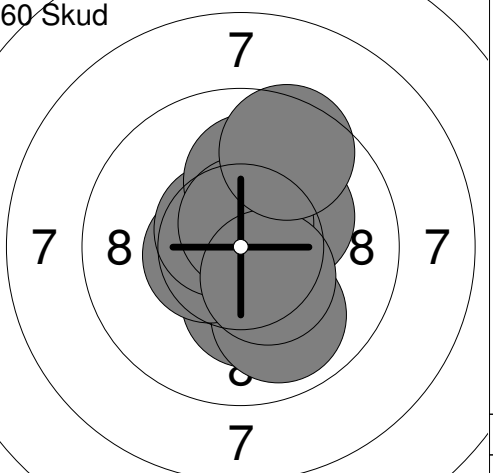
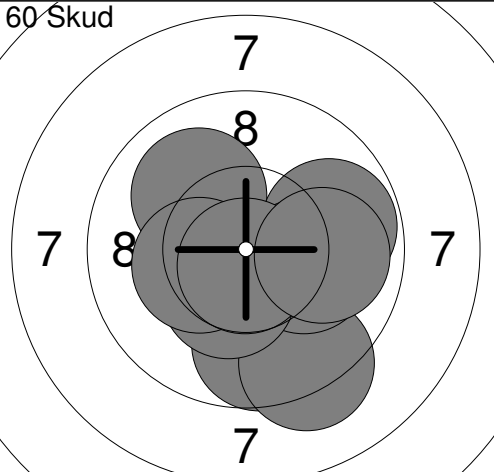
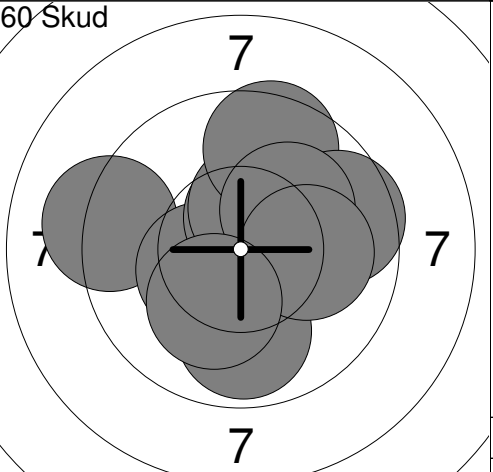
	10 meter stævne	Aalborg Skyttekreds
Prøve 	1: 10.5x → 2: 10.3x ← 3: 10.2x → 4: 10.5x → 5: 10.3x ← 6: 10.7x ← 7: 10.8x → 8: 10.3x ← 9: 9.7 ↓ 10: 10.3x ↓ <hr/> Serie 103.6 Total 0.0	Prøve 
		11: 10.0 ↓ 12: 9.8 ↑ 13: 10.8x ↘ 14: 10.3x ← 15: 10.5x ↘ <hr/> Serie 51.4 Total 0.0
60 Skud 	1: 10.3x → 2: 10.1 ← 3: 10.1 ↑ 4: 10.5x ↗ 5: 10.1 ↑ 6: 9.9 ← 7: 10.7x ↓ 8: 10.3x → 9: 9.6 ← 10: 10.0 ↓ <hr/> Serie 101.6 Total 101.6	60 Skud 
		11: 10.0 ↑ 12: 10.4x ↗ 13: 9.9 ↖ 14: 9.8 ↑ 15: 10.5x ↑ 16: 10.4x ↗ 17: 9.1 ↘ 18: 10.4x ↑ 19: 9.6 ↑ 20: 10.1 ← <hr/> Serie 100.2 Total 201.8
60 Skud 	21: 9.8 ↓ 22: 10.1 ↗ 23: 9.8 ← 24: 10.2x ↓ 25: 9.8 ↓ 26: 10.0 ↑ 27: 9.6 ↓ 28: 10.4x ↘ 29: 10.8x ← 30: 9.6 ↗ <hr/> Serie 100.1 Total 301.9	60 Skud 
		31: 10.2x ↓ 32: 10.8x ↓ 33: 9.9 ↓ 34: 10.5x ← 35: 10.2x ↗ 36: 10.6x ↖ 37: 10.1 ↑ 38: 10.6x ↑ 39: 10.4x ↘ 40: 9.6 ↑ <hr/> Serie 102.9 Total 404.8
60 Skud 	41: 9.7 ↓ 42: 10.3x ↘ 43: 9.3 ↓ 44: 10.0 ↗ 45: 9.8 → 46: 10.1 → 47: 10.4x ↓ 48: 10.3x ← 49: 10.7x ↓ 50: 9.9 → <hr/> Serie 100.5 Total 505.3	60 Skud 
		51: 9.2 ← 52: 10.4x ← 53: 10.5x ↑ 54: 10.4x ↑ 55: 9.9 ↓ 56: 9.6 ↑ 57: 9.6 → 58: 10.1 ↗ 59: 10.1 → 60: 10.2x ↓ <hr/> Serie 100.0 Total 605.3

Prøve		Prøve
	1: 10.5x ↗ 2: 10.1 ← 3: 10.3x ← 4: 10.7x → 5: 9.5 ↖ 6: 10.4x ← 7: 10.5x → 8: 10.1 ← 9: 10.1 ↓ 10: 10.2x ↗	
	Serie 102.4 Total 0.0	11: 10.2x ↖ 12: 10.5x → 13: 10.9x → 14: 10.5x ↘ 15: 10.0 ↑ 16: 10.5x → 17: 10.0 ↗
	Serie 102.4 Total 0.0	Serie 72.6 Total 0.0

60 Skud		60 Skud
	1: 10.0 ← 2: 9.7 → 3: 10.3x → 4: 10.1 → 5: 10.0 ↓ 6: 10.8x ↓ 7: 10.1 ↗ 8: 10.3x → 9: 10.5x ↗ 10: 10.5x ←	
	Serie 102.3 Total 102.3	11: 10.7x → 12: 10.4x ↓ 13: 10.3x → 14: 10.3x → 15: 10.7x ↑ 16: 10.7x ↗ 17: 10.2x ← 18: 9.8 ← 19: 10.6x ← 20: 9.5 →
	Serie 102.3 Total 102.3	Serie 103.2 Total 205.5

60 Skud		60 Skud
	21: 10.4x ↗ 22: 10.5x ↗ 23: 10.0 → 24: 10.4x → 25: 10.7x ← 26: 9.5 ↖ 27: 10.5x → 28: 10.3x ← 29: 10.3x ← 30: 10.9x ↖	
	Serie 103.5 Total 309.0	31: 9.3 ← 32: 10.8x → 33: 10.6x ↘ 34: 10.9x → 35: 10.5x ← 36: 10.8x ↓ 37: 10.4x → 38: 9.8 ↗ 39: 9.7 ← 40: 10.6x ↗
	Serie 103.5 Total 309.0	Serie 103.4 Total 412.4

60 Skud		60 Skud
	41: 10.3x ↗ 42: 10.4x ↗ 43: 10.0 ↖ 44: 10.1 ↓ 45: 10.2x → 46: 9.0 → 47: 10.6x → 48: 10.7x ↗ 49: 10.8x ↗ 50: 10.5x ↓	
	Serie 102.6 Total 515.0	51: 10.6x ↓ 52: 10.0 ↗ 53: 10.6x ↗ 54: 10.3x ↗ 55: 10.1 ↗ 56: 9.9 → 57: 10.4x ↗ 58: 10.5x ↗ 59: 10.8x ← 60: 9.8 ↘
	Serie 102.6 Total 515.0	Serie 103.0 Total 618.0

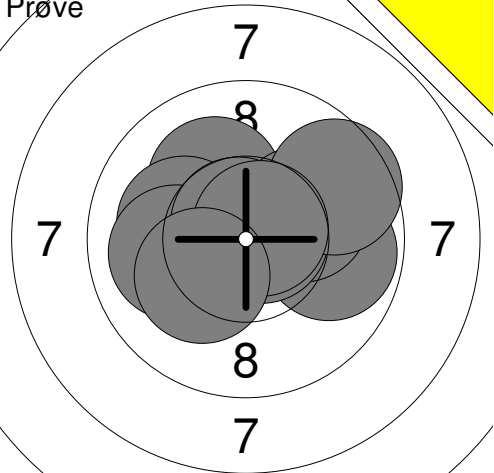
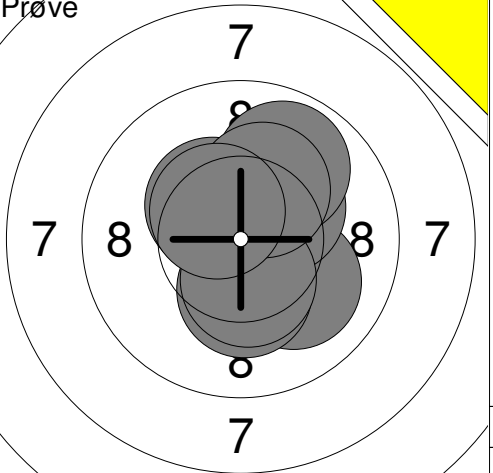
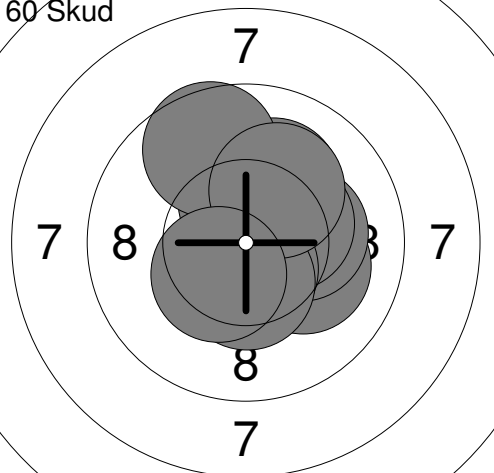
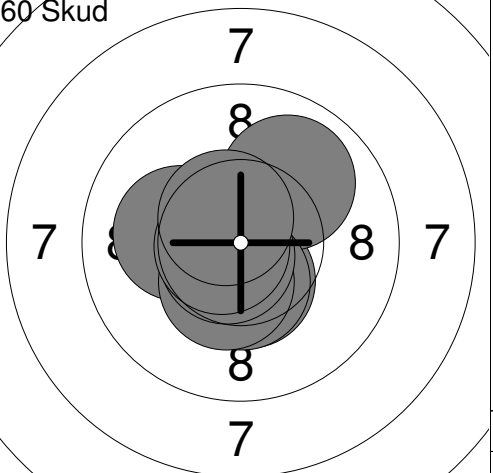
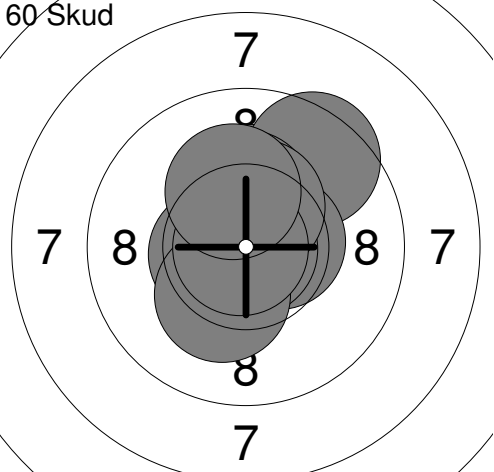
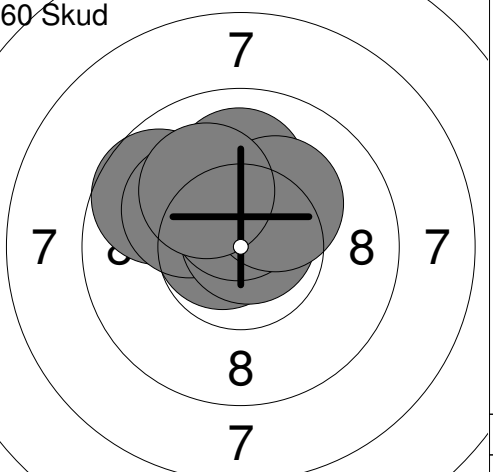
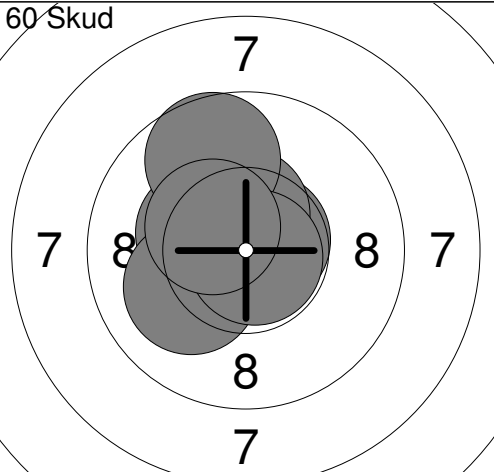
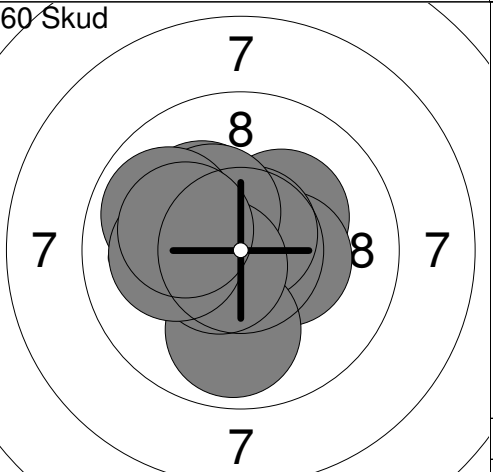
Hold	Skive	Lars Ørum		
6	8			
10m	Aalborg Skyttekreds		H R	
	10 meter stævne	Aalborg Skyttekreds		
Prøve		1: 9.8 →		11: 10.1 ↘
		2: 10.1 ↗		12: 10.3x ↓
		3: 10.1 →		13: 10.4x ↖
		4: 10.1 ←		14: 10.3x ↗
		5: 10.0 ←		15: 10.4x ↓
		6: 10.7x →		16: 9.9 ↗
		7: 9.6 ↗		17: 10.2x ↗
		8: 10.7x ↖		18: 10.5x ↖
		9: 10.7x ↗		
		10: 10.2x ↙		
		Serie 102.0		Serie 82.1
		Total 0.0		Total 0.0
60 Skud		1: 10.1 →		11: 10.6x ↙
		2: 10.4x ↑		12: 10.4x ↓
		3: 10.2x →		13: 10.8x ←
		4: 10.1 ↗		14: 9.9 ↗
		5: 9.6 ↖		15: 10.2x ←
		6: 10.4x →		16: 10.4x ↓
		7: 10.6x ↓		17: 10.4x ↓
		8: 10.4x ↓		18: 10.7x ↙
		9: 10.2x ↗		19: 10.7x ←
		10: 10.4x ↙		20: 10.6x ↖
		Serie 102.4		Serie 104.7
		Total 102.4		Total 207.1
60 Skud		21: 10.2x ↑		31: 10.7x ←
		22: 9.5 ↗		32: 9.7 ↖
		23: 10.5x ←		33: 10.1 ↖
		24: 10.3x ↑		34: 10.5x ↑
		25: 10.5x →		35: 10.0 ↑
		26: 10.9x ↘		36: 10.5x ↑
		27: 10.4x ↑		37: 10.8x ↗
		28: 10.3x ↓		38: 10.5x ↑
		29: 10.9x ←		39: 10.2x ↗
		30: 10.2x ↑		40: 10.1 ↖
		Serie 103.7		Serie 103.1
		Total 310.8		Total 413.9
60 Skud		41: 10.8x ↑		51: 10.3x ↗
		42: 10.7x ↗		52: 10.4x →
		43: 10.2x ↖		53: 10.7x ↗
		44: 10.7x ↖		54: 10.2x ↖
		45: 10.3x ↖		55: 10.3x ↖
		46: 10.5x ↑		56: 9.9 ↓
		47: 9.7 ↗		57: 9.9 ↖
		48: 10.1 ←		58: 10.6x ↙
		49: 10.8x ↘		59: 10.1 ←
		50: 10.4x ↖		60: 10.2x ←
		Serie 104.2		Serie 102.6
		Total 518.1		Total 620.7

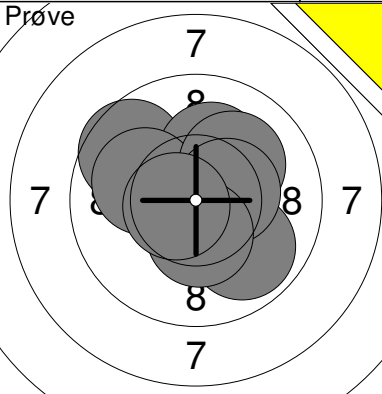
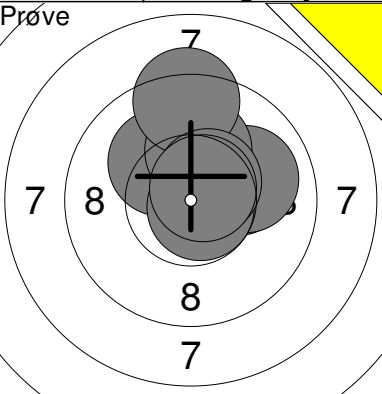
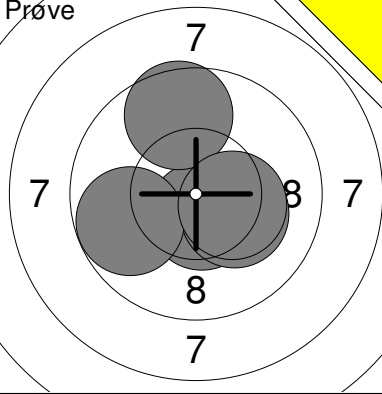
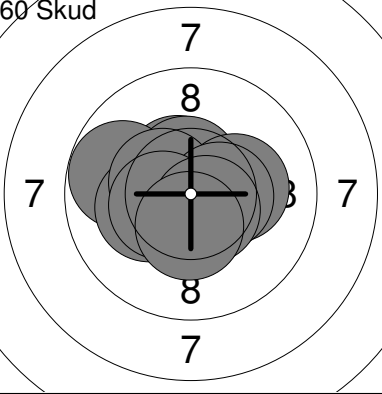
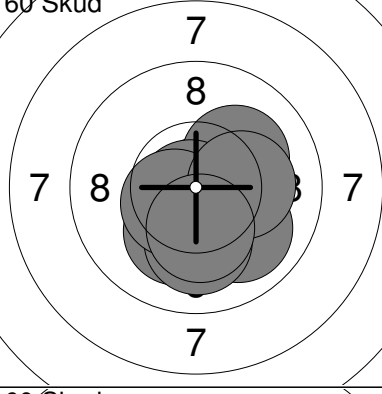
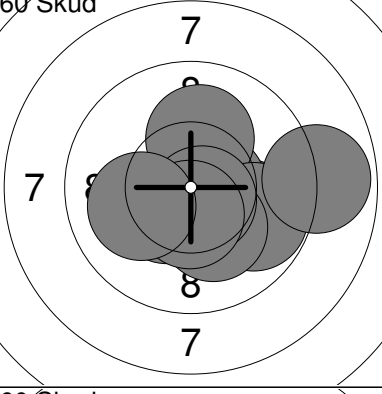
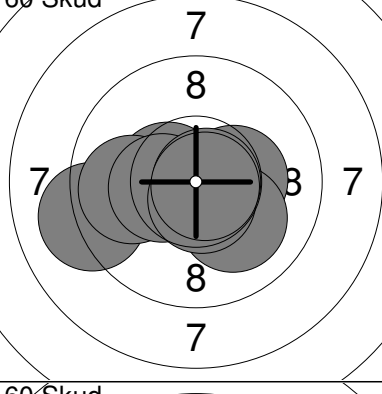
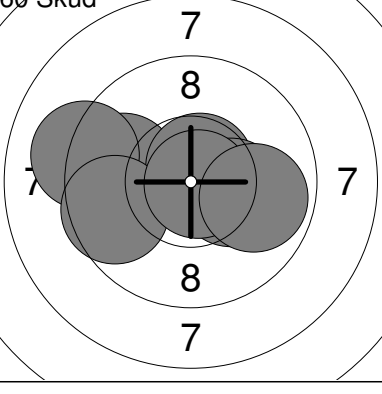
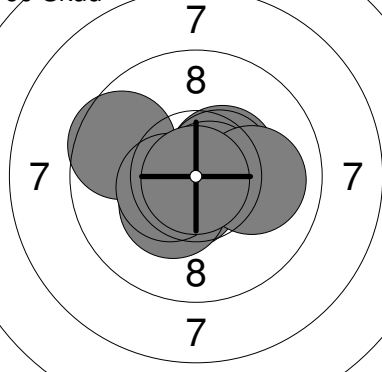

Hold	Skive	Alexander Helleskov					
6	9	Trehøje Skytteforening		H	R		
10m		10 meter stævne		Aalborg Skyttekreds			
Prøve		1: 10.5x	←	Prøve		11: 10.2x	↗
		2: 9.9	↘			12: 10.1	→
		3: 10.4x	↗			13: 10.2x	→
		4: 9.6	↗			14: 10.1	→
		5: 10.2x	↗			15: 10.0	→
		6: 10.0	↖			16: 10.1	↑
		7: 10.1	↗			17: 10.7x	↘
		8: 10.4x	→			18: 9.3	↑
		9: 10.4x	↘			19: 10.5x	↗
		10: 10.6x	←			20: 10.7x	↗
		Serie	102.1			Serie	101.9
		Total	0.0			Total	0.0
Prøve		21: 10.6x	↘	60 Skud		1: 10.5x	↗
		22: 10.2x	→			2: 9.8	←
		23: 9.6	↗			3: 10.5x	↑
		24: 9.8	←			4: 10.2x	→
		25: 10.3x	→			5: 10.2x	←
		Serie	50.5			6: 10.4x	←
		Total	0.0			7: 10.5x	→
						8: 10.5x	←
						9: 10.6x	↘
						10: 10.4x	↓
		Serie	50.5			Serie	103.6
		Total	0.0			Total	103.6
60 Skud		11: 10.8x	→	60 Skud		21: 10.0	→
		12: 10.2x	↘			22: 10.4x	↖
		13: 10.7x	↖			23: 10.6x	→
		14: 10.0	↘			24: 10.1	↑
		15: 10.1	↘			25: 9.8	↘
		16: 10.1	↗			26: 10.2x	↘
		17: 10.8x	↖			27: 10.7x	↘
		18: 10.5x	↖			28: 10.5x	↓
		19: 10.2x	→			29: 8.9	→
		20: 10.3x	↓			30: 10.1	←
		Serie	103.7			Serie	101.3
		Total	207.3			Total	308.6
60 Skud		31: 9.1	←	60 Skud		41: 10.7x	→
		32: 10.5x	←			42: 10.9x	↗
		33: 10.4x	→			43: 9.8	←
		34: 9.9	←			44: 10.7x	→
		35: 10.3x	→			45: 9.1	←
		36: 10.4x	←			46: 10.7x	↗
		37: 10.1	↘			47: 10.3x	→
		38: 10.6x	↘			48: 9.6	←
		39: 10.8x	→			49: 10.8x	→
		40: 10.8x	↘			50: 9.9	→
		Serie	102.9			Serie	102.5
		Total	411.5			Total	514.0
60 Skud		51: 10.4x	↗				
		52: 10.7x	↖				
		53: 10.5x	↗				
		54: 10.7x	→				
		55: 10.6x	↘				
		56: 9.6	↖				
		57: 10.4x	↘				
		58: 10.0	→				
		59: 10.5x	←				
		60: 10.9x	↓				
		Serie	104.3				
		Total	618.3				

	10 meter stævne	Aalborg Skyttekreds
--	-----------------	---------------------

Prøve 	1: 10.0 ↑ 2: 10.3x ↓ 3: 10.3x ← 4: 10.5x ↗ 5: 10.2x ← 6: 10.3x ↑ 7: 10.8x ↓ 8: 10.3x ↓ 9: 10.2x ↘ 10: 10.2x →	Prøve 	11: 10.3x ← 12: 9.5 ↗ 13: 10.7x ↗ 14: 9.0 → 15: 10.1 ↗ 16: 9.9 ↓ 17: 10.3x ↓ 18: 10.0 → 19: 10.4x ↗ 20: 10.0 ↓
Serie 103.1		Serie 100.2	
Total 0.0		Total 0.0	

Prøve 	21: 10.6x ↓ 22: 9.9 ← 23: 10.9x ↑ 24: 10.7x →	60 Skud 	1: 9.6 → 2: 10.7x ↗ 3: 10.7x ↓ 4: 10.6x ← 5: 10.8x → 6: 9.4 ↗ 7: 9.7 ← 8: 9.8 ↗ 9: 9.9 ↑ 10: 10.5x ↗
Serie 42.1		Serie 101.7	
Total 0.0		Total 101.7	

60 Skud 	11: 10.3x ← 12: 9.8 → 13: 10.2x ↗ 14: 10.2x ↗ 15: 9.8 ↑ 16: 10.2x ↑ 17: 9.3 ↗ 18: 10.4x ↗ 19: 9.9 ← 20: 10.3x ↗	60 Skud 	21: 10.5x ↓ 22: 10.7x ↓ 23: 10.8x ← 24: 10.2x → 25: 9.4 ↗ 26: 10.7x ↓ 27: 10.0 ← 28: 10.3x ↓ 29: 9.9 ↓ 30: 10.0 ↗
Serie 100.4		Serie 102.5	
Total 202.1		Total 304.6	

60 Skud 	31: 10.2x ↑ 32: 10.6x ↓ 33: 10.5x → 34: 10.0 ↓ 35: 10.0 ← 36: 10.5x → 37: 10.7x ← 38: 10.5x ↗ 39: 10.7x ↓ 40: 9.9 →	60 Skud 	41: 9.8 ← 42: 10.6x ↓ 43: 9.8 ↓ 44: 10.5x ↓ 45: 10.4x ↓ 46: 10.0 ← 47: 10.6x ↓ 48: 10.1 ↓ 49: 10.0 ↓ 50: 9.1 ←
Serie 103.6		Serie 100.9	
Total 408.2		Total 509.1	

60 Skud 	51: 10.1 ← 52: 10.3x ↓ 53: 10.6x ↗ 54: 10.8x ↓ 55: 10.6x ↗ 56: 10.2x ↓ 57: 10.4x → 58: 10.5x ← 59: 10.0 ← 60: 9.7 ↓		
Serie 103.2			
Total 612.3			

Hold	Skive	Kristian Thomsen		
6	11			
10m	Trehøje Skytteforening	HJ	R	
	10 meter stævne	Aalborg Skyttekreds		
Prøve		1: 8.6 ← 2: 9.7 ↖ 3: 8.6 ← 4: 10.1 ↘ 5: 10.1 ↗ 6: 10.3x ↗ 7: 8.9 ← 8: 9.4 → 9: 10.8x ↑ 10: 10.2x ↘ Serie 96.7 Total 0.0	Prøve 	11: 9.8 ↘ 12: 9.5 ↗ 13: 10.4x ↗ 14: 10.0 ↗ Serie 39.7 Total 0.0
60 Skud		1: 10.6x ↘ 2: 10.6x ↖ 3: 9.1 ↗ 4: 9.6 ← 5: 9.1 ↘ 6: 9.8 → 7: 10.5x ← 8: 9.0 → 9: 10.0 ↑ 10: 9.9 → Serie 98.2 Total 98.2	60 Skud 	11: 10.6x ← 12: 10.0 ↘ 13: 10.6x ← 14: 10.2x ↓ 15: 9.8 ↗ 16: 10.7x ↓ 17: 10.0 ↓ 18: 10.1 ↗ 19: 10.1 ↗ 20: 10.6x → Serie 102.7 Total 200.9
60 Skud		21: 9.6 → 22: 10.6x ↘ 23: 9.6 → 24: 10.0 → 25: 10.6x ↗ 26: 9.7 → 27: 10.0 ↗ 28: 10.5x ↑ 29: 10.5x ↓ 30: 10.7x ↓ Serie 101.8 Total 302.7	60 Skud 	31: 10.6x ↑ 32: 10.7x ↗ 33: 10.2x ↖ 34: 10.3x ↘ 35: 10.5x ↖ 36: 10.7x → 37: 10.0 ↑ 38: 9.5 ← 39: 10.9x ↑ 40: 10.6x ↖ Serie 104.0 Total 406.7
60 Skud		41: 10.4x ↓ 42: 10.2x ↗ 43: 10.0 ↓ 44: 10.2x ↖ 45: 10.4x → 46: 10.3x ↗ 47: 10.0 ↓ 48: 10.1 ← 49: 10.6x ↑ 50: 9.6 ↘ Serie 101.8 Total 508.5	60 Skud 	51: 10.4x ↗ 52: 10.1 ↖ 53: 10.4x → 54: 10.3x ↓ 55: 10.6x ↑ 56: 10.0 → 57: 10.5x ↖ 58: 10.4x ↗ 59: 10.3x ↑ 60: 10.0 ↖ Serie 103.0 Total 611.5

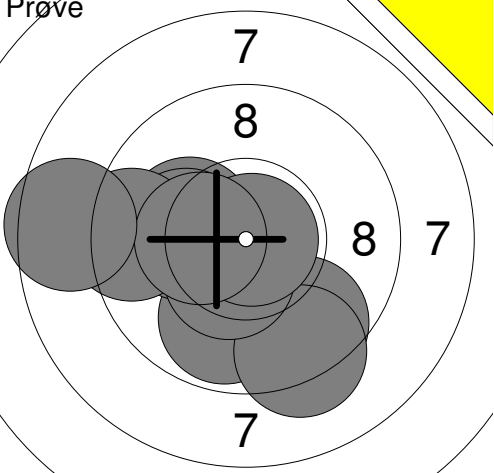
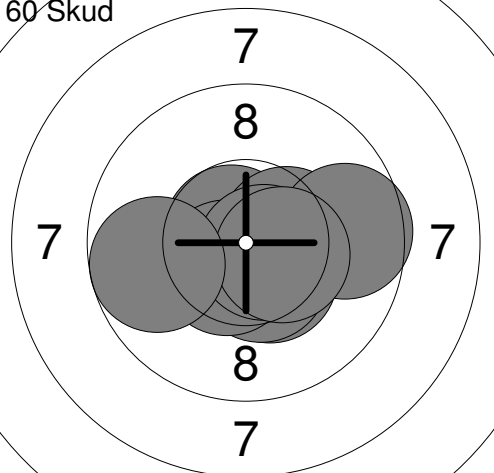
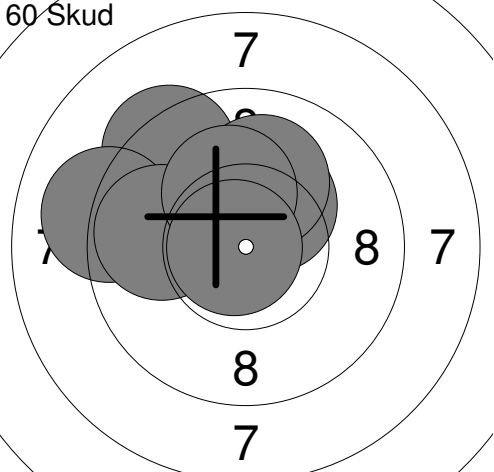
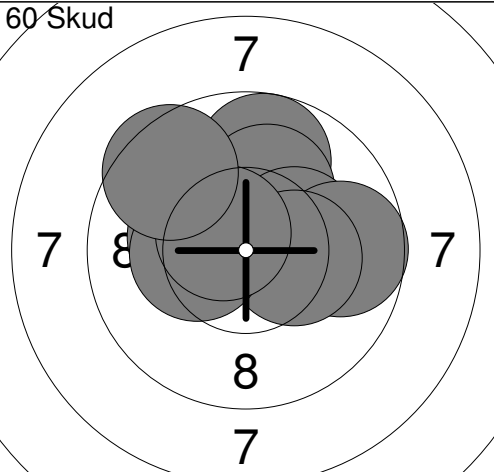
Hold	Skive	Henrik Frankfurth	
6	12		
10m	Aalborg Skyttekreds	H	R
	10 meter stævne	Aalborg Skyttekreds	
Prøve		1: 9.8 ↓	11: 8.3 ←
		2: 10.2x ←	12: 10.7x ↓
		3: 9.6 ↓	13: 9.5 ↘
		4: 10.1 ←	14: 10.1 ↑
		5: 9.3 ↓	15: 10.0 ↗
		6: 9.4 ←	16: 9.8 ↓
		7: 10.4x ↓	17: 10.4x ↓
		8: 10.9x →	18: 10.2x ↖
		9: 10.3x ←	19: 10.1 ↑
		10: 8.6 ←	20: 10.3x ↓
	Serie 98.6	Serie 99.4	
	Total 0.0	Total 0.0	
60 Skud		1: 10.4x ↓	11: 9.5 ←
		2: 10.7x ↖	12: 9.4 ↓
		3: 10.4x →	13: 10.3x ←
		4: 10.6x ↓	14: 10.2x ←
		5: 10.5x ↓	15: 10.1 ↓
		6: 9.6 →	16: 9.5 ←
		7: 10.5x ↓	17: 9.8 ←
		8: 10.7x ↓	18: 9.5 →
		9: 10.4x →	19: 10.2x ↓
		10: 9.7 ←	20: 9.8 ↗
	Serie 103.5	Serie 98.3	
	Total 103.5	Total 201.8	
60 Skud		21: 10.3x ↗	31: 9.9 →
		22: 9.9 ↖	32: 10.8x ↓
		23: 9.6 ↗	33: 10.1 ↓
		24: 10.6x ↗	34: 10.4x →
		25: 9.4 ↗	35: 10.2x →
		26: 9.1 ←	36: 10.4x ↑
		27: 9.8 ←	37: 10.0 →
		28: 10.1 ↑	38: 9.9 ↗
		29: 10.2x ↑	39: 10.3x ↑
		30: 10.8x ←	40: 9.9 ↗
	Serie 99.8	Serie 101.9	
	Total 301.6	Total 403.5	
60 Skud		41: 10.5x ↖	51: 10.6x ↖
		42: 9.8 ↑	52: 9.9 →
		43: 10.1 ↑	53: 10.4x ←
		44: 10.3x →	54: 10.2x ↓
		45: 9.7 →	55: 9.9 ←
		46: 10.3x ←	56: 10.6x →
		47: 10.3x →	57: 10.8x ↓
		48: 10.3x ←	58: 10.0 ↓
		49: 10.6x ↗	59: 9.4 →
		50: 9.5 ↗	60: 10.0 ↗
	Serie 101.4	Serie 101.8	
	Total 504.9	Total 606.7	

Hold	Skive	Morten Larsen	
9	2		
10m	Vester Hassing	H	R
	10 meter stævne	Aalborg Skyttekreds	
	1: 4.8 ↗ 2: 10.4x ↖ 3: 10.3x ↖ 4: 7.2 → 5: 6.0 ↗ 6: 8.7 ↗ 7: 8.4 → 8: 8.0 ↗ 9: 9.0 ↗ 10: 10.2x → Serie 83.0 Total 0.0		11: 9.0 ↗ 12: 9.5 ↖ 13: 9.7 ↗ 14: 7.0 → 15: 10.3x ↗ 16: 8.6 ↗ 17: 10.9x ↘ 18: 9.4 ↖ 19: 9.7 ↗ 20: 10.3x ↗ Serie 94.4 Total 0.0
	21: 7.2 → Serie 7.2 Total 0.0		1: 9.6 ↖ 2: 9.2 ↘ 3: 9.8 ↖ 4: 10.5x ↘ 5: 7.7 → 6: 8.3 → 7: 9.4 → 8: 8.0 ↗ 9: 8.9 ↘ 10: 8.5 → Serie 89.9 Total 89.9
	11: 9.8 ↗ 12: 9.1 → 13: 6.2 → 14: 9.9 ↗ 15: 8.4 ↗ 16: 10.3x ↘ 17: 10.2x ↘ 18: 9.3 → 19: 9.3 → 20: 9.6 ↗ Serie 92.1 Total 182.0		21: 9.5 ↗ 22: 9.1 ↗ 23: 9.3 ↖ 24: 9.1 → 25: 8.7 ↗ 26: 7.6 ↗ 27: 10.1 → 28: 10.0 ↖ 29: 8.6 ↗ 30: 9.2 ↗ Serie 91.2 Total 273.2
	31: 7.5 → 32: 9.7 ↗ 33: 8.3 → 34: 9.4 → 35: 7.4 ↗ 36: 8.5 ↗ 37: 9.8 ↗ 38: 7.9 ↗ 39: 9.3 → 40: 9.1 → Serie 86.9 Total 360.1		41: 9.1 → 42: 9.9 → 43: 7.6 ↖ 44: 9.7 ↗ 45: 8.1 ↘ 46: 8.3 ↗ 47: 8.4 ↘ 48: 10.4x ↖ 49: 10.4x ↗ 50: 10.0 ↗ Serie 91.9 Total 452.0
	51: 8.6 ↗ 52: 9.7 ↖ 53: 9.4 ↖ 54: 10.3x ↖ 55: 9.5 ↗ 56: 10.1 ↘ 57: 10.7x ↘ 58: 9.4 ↗ 59: 9.3 ↘ 60: 9.6 ↘ Serie 96.6 Total 548.6		

	10 meter stævne	Aalborg Skyttekreds
--	-----------------	---------------------

<p>Prøve</p>	<p>1: 6.4 → 2: 10.3x ↓ 3: 8.8 ↓ 4: 9.0 ↓ 5: 9.2 ↓ 6: 8.9 ↓ 7: 8.4 ← 8: 9.1 ↓ 9: 9.6 → 10: 4.0 →</p> <p>Serie 83.7 Total 0.0</p>	<p>Prøve</p>	<p>11: 8.4 ↖ 12: 9.5 ↑ 13: 10.2x ↑ 14: 9.1 ↖ 15: 9.7 ↓ 16: 10.1 ↖ 17: 10.1 ↓ 18: 10.5x ↗ 19: 9.7 ↓ 20: 9.9 ↖</p> <p>Serie 97.2 Total 0.0</p>
--------------	-------------------------------------------------------------------------------------------------------------------------------------------------------------------------	--------------	--------------------------------------------------------------------------------------------------------------------------------------------------------------------------------------

<p>Prøve</p>	<p>21: 10.7x ↑ 22: 10.3x ↓ 23: 10.2x → 24: 10.4x → 25: 10.6x →</p> <p>Serie 52.2 Total 0.0</p>	<p>40 Skud</p>	<p>1: 10.2x ← 2: 10.7x ↗ 3: 10.1 ↓ 4: 9.8 ↓ 5: 9.6 ↗ 6: 10.3x ↑ 7: 9.1 ← 8: 9.4 ← 9: 7.7 ← 10: 10.7x ↗</p> <p>Serie 97.6 Total 97.6</p>
--------------	--------------------------------------------------------------------------------------------------------------------	----------------	---------------------------------------------------------------------------------------------------------------------------------------------------------------------------------

<p>40 Skud</p>	<p>11: 9.3 ← 12: 10.0 ↑ 13: 10.1 ↗ 14: 8.8 ↗ 15: 10.0 ↗ 16: 8.2 ↓ 17: 8.9 ← 18: 10.2x → 19: 9.6 ↑ 20: 10.3x ←</p> <p>Serie 95.4 Total 193.0</p>	<p>40 Skud</p>	<p>21: 9.6 ↑ 22: 9.8 ↑ 23: 9.6 → 24: 9.9 ↓ 25: 9.7 ↓ 26: 9.6 ↘ 27: 10.3x ← 28: 5.2 ← 29: 9.9 ↓ 30: 9.5 ↗</p> <p>Serie 93.1 Total 286.1</p>
----------------	-----------------------------------------------------------------------------------------------------------------------------------------------------------------------------------------	----------------	------------------------------------------------------------------------------------------------------------------------------------------------------------------------------------

<p>40 Skud</p>	<p>31: 10.0 ↓ 32: 9.1 ↗ 33: 9.8 ↗ 34: 9.3 ↓ 35: 9.3 ← 36: 9.6 ← 37: 9.2 → 38: 9.2 ↑ 39: 10.5x ↓ 40: 7.6 ←</p> <p>Serie 93.6 Total 379.7</p>		
----------------	-------------------------------------------------------------------------------------------------------------------------------------------------------------------------------------	--	--

	10 meter stævne	Aalborg Skyttekreds
--	-----------------	---------------------

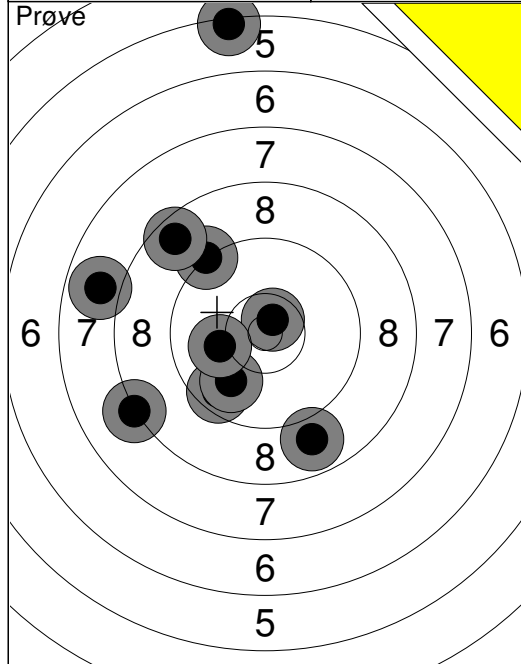

1: 5.3	↑
2: 8.9	↓
3: 9.6	↙
4: 9.9	↙
5: 10.7x	↗
6: 8.2	↙
7: 7.9	↙
8: 10.1	↙
9: 9.2	↗
10: 8.6	↖
Serie 83.0	
Total 0.0	

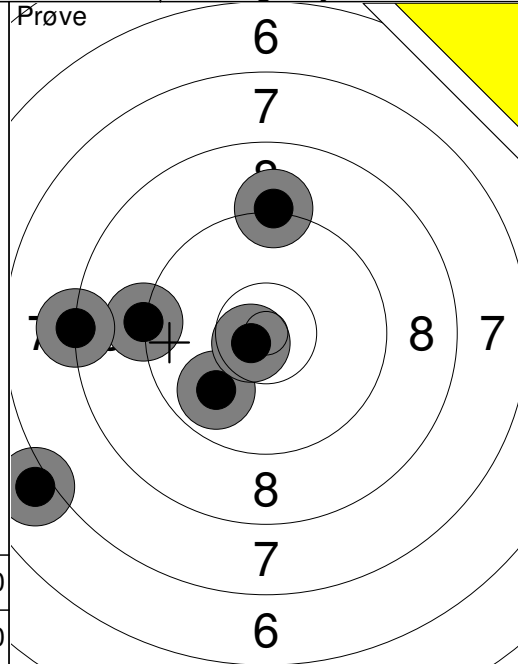

11: 9.2	↑
12: 7.0	↙
13: 9.2	↙
14: 9.9	↙
15: 10.7x	↙
16: 8.2	↙
Serie 52.0	
Total 0.0	

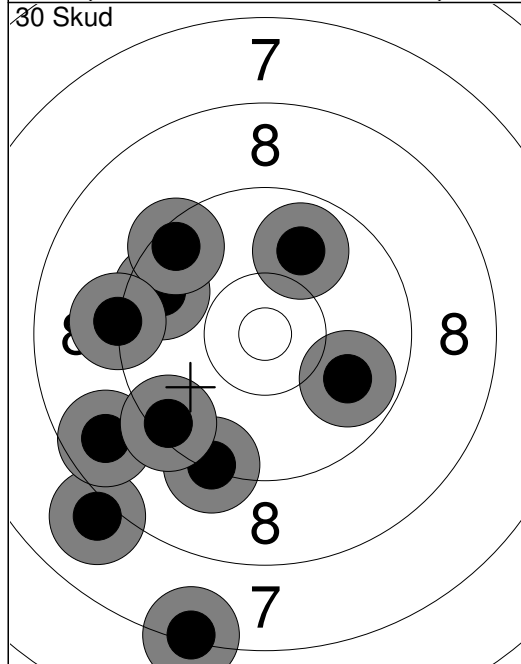

1: 9.3	↙
2: 7.3	↓
3: 8.0	↙
4: 9.6	↙
5: 9.5	↗
6: 8.7	↙
7: 9.2	↙
8: 9.9	↘
9: 9.9	↗
10: 9.4	↙
Serie 86.0	
Total 86.0	

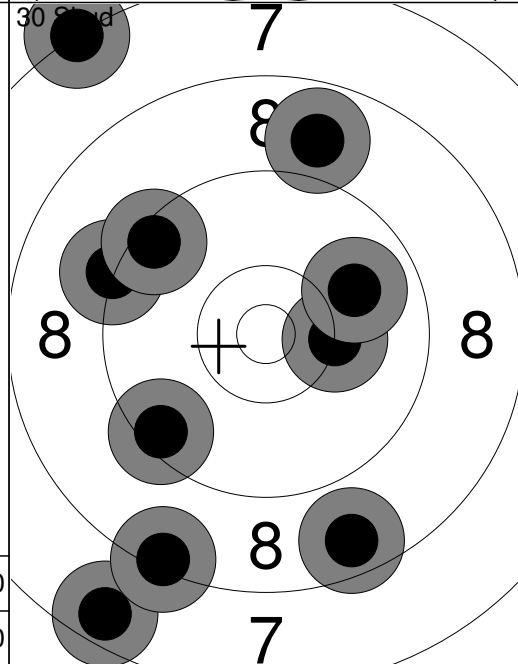

11: 10.2	→
12: 9.9	↗
13: 7.2	↖
14: 8.6	↓
15: 7.6	↙
16: 8.3	↙
17: 8.8	↑
18: 9.2	↙
19: 9.4	↖
20: 9.4	↙
Serie 84.0	
Total 170.0	

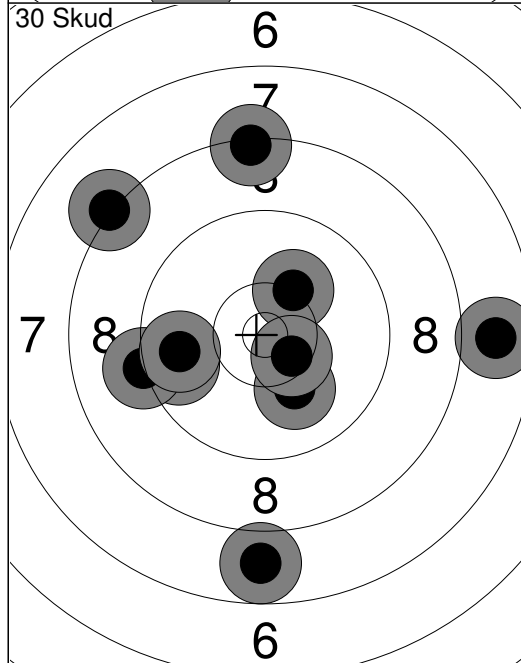

21: 7.8	↓
22: 7.8	→
23: 10.2	↗
24: 8.2	↖
25: 9.7	↙
26: 9.2	↙
27: 10.1	↓
28: 10.5x	↘
29: 9.7	↙
30: 8.3	↑
Serie 87.0	
Total 257.0	

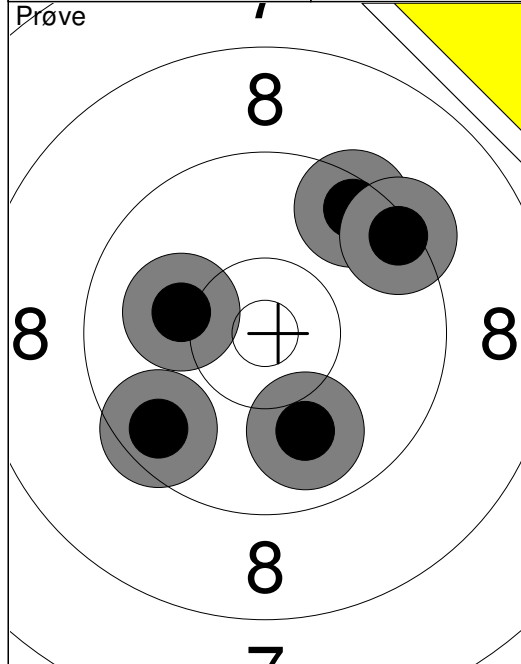

1:	9.5	↗
2:	9.4	↗
3:	9.9	↘
4:	9.6	↙
5:	10.1	↖
Serie		46.0
Total		0.0

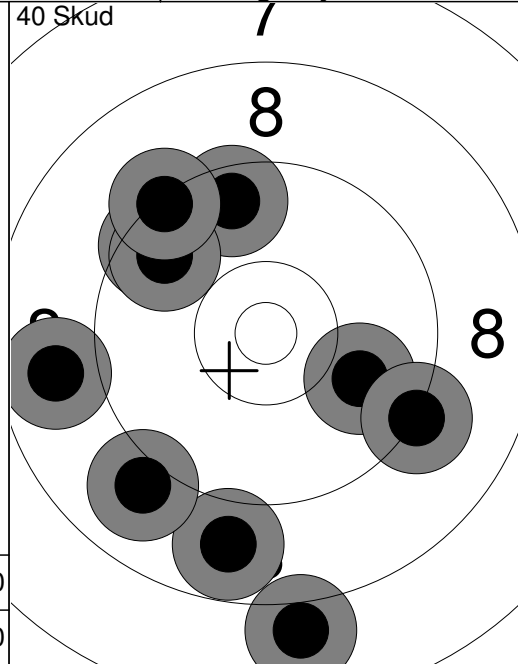

1:	9.9	↘
2:	8.8	↘
3:	8.0	↘
4:	9.2	↘
5:	9.6	↗
6:	8.8	↖
7:	9.0	↙
8:	9.5	↗
9:	9.7	↗
10:	9.3	↗
Serie		87.0
Total		87.0

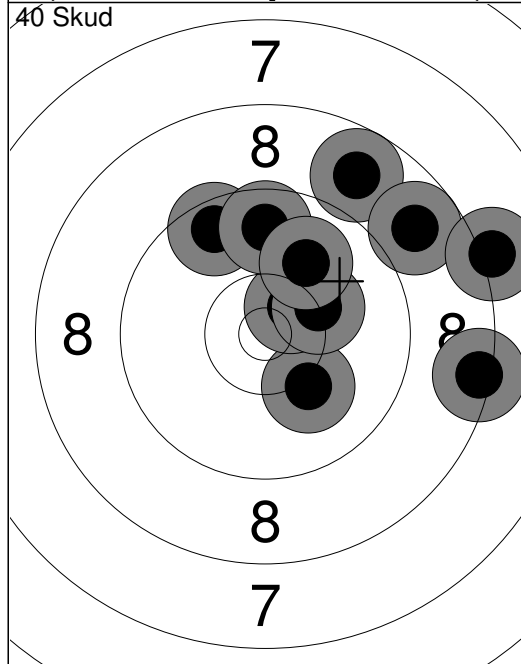

11:	8.8	↗
12:	9.6	↗
13:	10.2	↘
14:	10.5x	↗
15:	9.7	↑
16:	8.8	↗
17:	10.2	↗
18:	8.4	→
19:	8.1	→
20:	10.0	↗
Serie		90.0
Total		177.0

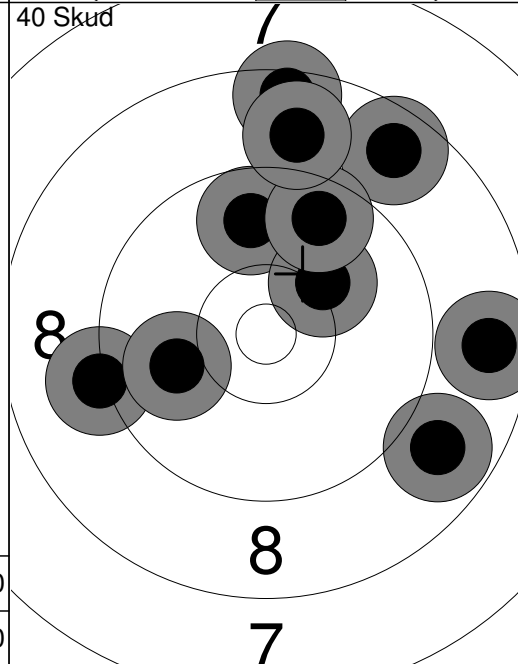

21:	9.2	↖
22:	8.8	↘
23:	9.8	↑
24:	8.6	↗
25:	10.0	↖
26:	8.5	↑
27:	10.2	↗
28:	9.6	↗
29:	8.7	→
30:	8.9	↑
Serie		87.0
Total		264.0

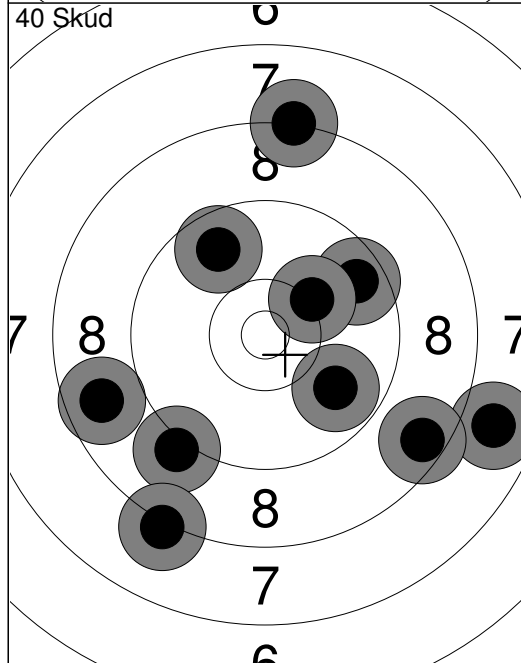

31:	9.8	↘
32:	9.6	↗
33:	9.7	↗
34:	9.1	↙
35:	8.2	↑
36:	7.8	↘
37:	8.2	↙
38:	8.5	↘
39:	8.7	↖
40:	10.2	↗
Serie		85.0
Total		349.0



Prøve 	1: 9.4 ↖ 2: 10.4x ↗ 3: 8.2 ↗ 4: 10.9x ↗ 5: 10.3 ↓ 6: 10.5x ↗ 7: 9.1 ↘ 8: 8.9 ↘ 9: 9.4 → 10: 9.6 ← <hr/> Serie 92.0 Total 0.0	Prøve 	11: 8.8 ↗ 12: 9.3 → 13: 9.8 ↘ 14: 10.3 ↖ 15: 9.6 → 16: 10.4x ↗ 17: 10.1 → 18: 10.6x ↗ 19: 10.0 ↓ 20: 8.7 ↗ <hr/> Serie 93.0 Total 0.0
-----------	---------------------------------------------------------------------------------------------------------------------------------------------------------------	-----------	------------------------------------------------------------------------------------------------------------------------------------------------------------------------

60 Skud 	1: 9.9 ↓ 2: 9.1 ↓ 3: 9.4 ↓ 4: 8.5 ↓ 5: 10.0 → 6: 10.3 → 7: 8.1 ↓ 8: 9.0 → 9: 9.3 ↓ 10: 10.4x ↓ <hr/> Serie 91.0 Total 91.0	60 Skud 	11: 10.2 ↗ 12: 9.2 ↘ 13: 10.2 → 14: 10.5x → 15: 9.6 ↓ 16: 9.2 → 17: 8.4 ↗ 18: 9.0 ↑ 19: 9.8 ↗ 20: 9.0 ↘ <hr/> Serie 92.0 Total 183.0
-------------	-------------------------------------------------------------------------------------------------------------------------------------------------------------	-------------	-----------------------------------------------------------------------------------------------------------------------------------------------------------------------

60 Skud 	21: 9.3 ↓ 22: 10.3 ↓ 23: 9.0 ↓ 24: 10.2 ↓ 25: 10.2 ↑ 26: 9.6 → 27: 9.1 → 28: 10.4x ↓ 29: 10.0 ↑ 30: 10.4x → <hr/> Serie 96.0 Total 279.0	60 Skud 	31: 10.3 ↘ 32: 10.8x ← 33: 8.9 → 34: 7.8 ↓ 35: 10.3 ← 36: 10.4x → 37: 8.9 ↓ 38: 9.9 ↑ 39: 9.6 ↗ 40: 10.3 ↓ <hr/> Serie 91.0 Total 370.0
-------------	---------------------------------------------------------------------------------------------------------------------------------------------------------------------------	-------------	--------------------------------------------------------------------------------------------------------------------------------------------------------------------------

60 Skud 	41: 10.3 ↓ 42: 10.2 → 43: 9.9 ↗ 44: 9.9 ↓ 45: 8.5 → 46: 9.5 ↗ 47: 9.8 ↓ 48: 9.5 → 49: 9.6 → 50: 10.2 ↓ <hr/> Serie 92.0 Total 462.0	60 Skud 	51: 10.4x ↓ 52: 9.7 ↗ 53: 8.4 → 54: 9.2 → 55: 10.1 ← 56: 8.0 ↓ 57: 10.4x ↗ 58: 10.1 → 59: 9.3 ← 60: 9.5 ↗ <hr/> Serie 92.0 Total 554.0
-------------	----------------------------------------------------------------------------------------------------------------------------------------------------------------------	-------------	-------------------------------------------------------------------------------------------------------------------------------------------------------------------------

10 meter stævne		Aalborg Skyttekreds	
Prøve 	1: 8.6 → 2: 10.4 → 3: 10.2 ↙ 4: 9.9 ↑ 5: 9.5 ← 6: 8.9 ↗ 7: 9.2 ← 8: 9.8 ↙ 9: 10.2 ↑ 10: 9.1 ← Serie 91.0 Total 0.0	Prøve 	11: 9.4 ← 12: 9.6 ↙ 13: 9.3 ↑ Serie 27.0 Total 0.0
40 Skud 	1: 8.7 ↙ 2: 10.4x ↓ 3: 9.0 ↙ 4: 7.8 → 5: 9.1 ↙ 6: 9.9 ↙ 7: 9.2 ↗ 8: 7.5 ↑ 9: 7.5 ↑ 10: 10.5x ↑ Serie 85.0 Total 85.0	40 Skud 	11: 10.3 → 12: 9.9 → 13: 9.6 ↘ 14: 9.5 ↑ 15: 9.3 ↑ 16: 9.5 ↘ 17: 8.4 ← 18: 9.2 ↙ 19: 9.1 ↗ 20: 9.7 → Serie 90.0 Total 175.0
40 Skud 	21: 8.1 ↗ 22: 9.7 → 23: 8.0 ↑ 24: 9.5 ↗ 25: 9.4 ↘ 26: 8.4 ← 27: 9.8 ← 28: 10.7x ↘ 29: 8.9 ↗ 30: 7.2 ↙ Serie 85.0 Total 260.0	40 Skud 	31: 8.9 ↙ 32: 10.6x → 33: 10.1 ↘ 34: 8.5 ↗ 35: 9.9 ↗ 36: 10.4x ↙ 37: 8.7 ↗ 38: 9.7 ↑ 39: 8.5 ↗ 40: 9.3 ↑ Serie 89.0 Total 349.0

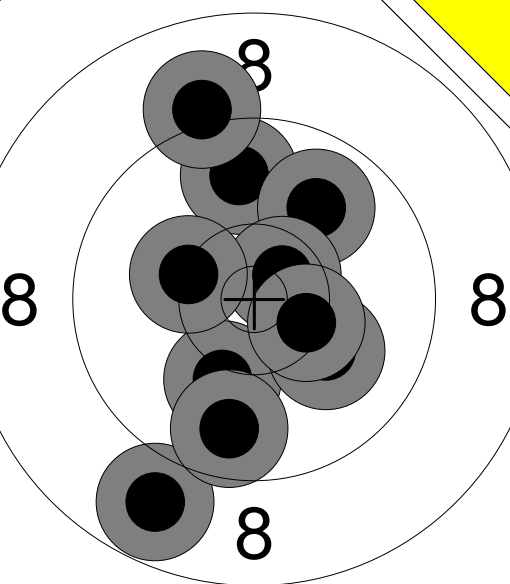
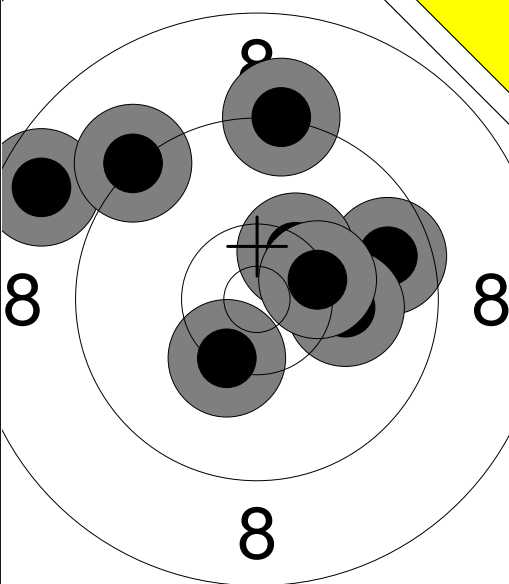
Prøve 	1: 10.1 ↘ 2: 9.8 ↗ 3: 10.1 ↘ 4: 9.9 ↗ 5: 10.6x ↗ 6: 8.8 ↘ 7: 10.4x ↘ 8: 9.1 ↗ 9: 9.7 ↘ 10: 10.3 ↖	Prøve 	11: 10.3 ↘ 12: 8.7 ↖ 13: 9.2 ↗ 14: 9.6 → 15: 9.2 ↗ 16: 10.1 → 17: 10.4x ↗ 18: 10.3 →
Serie 94.0		Serie 75.0	
Total 0.0		Total 0.0	

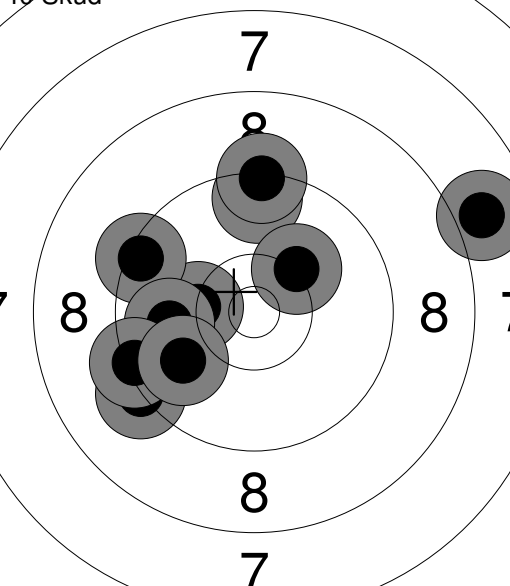
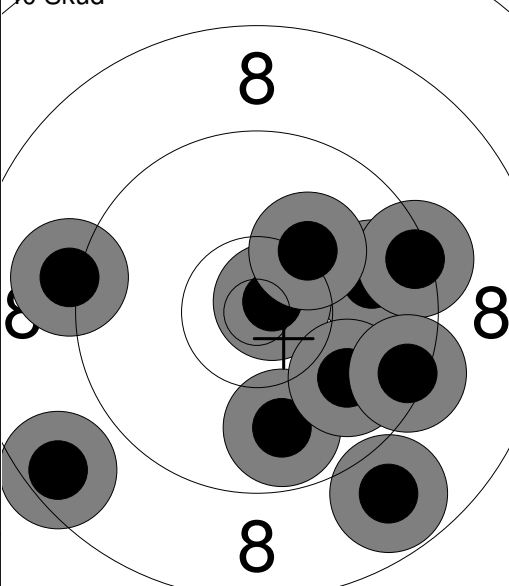
40 Skud 	1: 10.3 ↖ 2: 9.4 ↖ 3: 9.5 ↗ 4: 10.2 ↗ 5: 9.9 ↖ 6: 9.3 ↗ 7: 7.9 → 8: 9.2 ↖ 9: 9.4 ↖ 10: 9.9 ↖	40 Skud 	11: 9.8 ↘ 12: 9.1 ↖ 13: 9.8 → 14: 10.8x ↗ 15: 8.5 ↖ 16: 8.8 ↘ 17: 9.9 ↘ 18: 9.4 → 19: 10.2 ↗ 20: 9.4 →
Serie 90.0		Serie 90.0	
Total 90.0		Total 180.0	

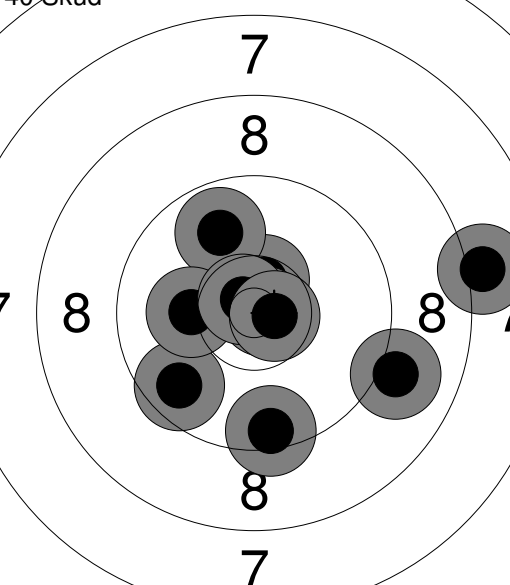
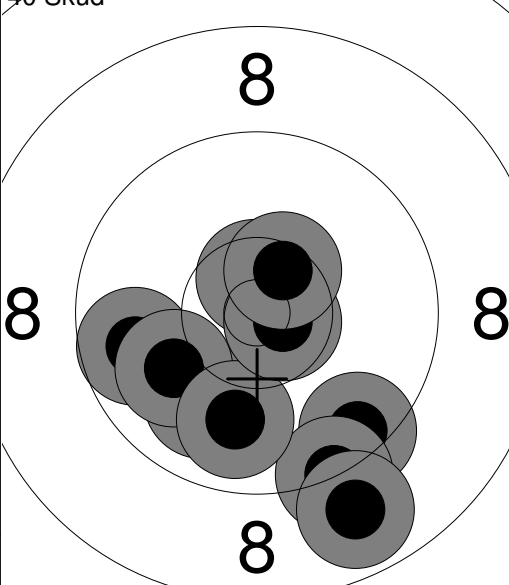
40 Skud 	21: 9.6 ↘ 22: 10.5x ↗ 23: 10.8x → 24: 9.9 ↗ 25: 9.5 ↘ 26: 10.2 ↖ 27: 10.7x ↗ 28: 8.0 → 29: 10.7x → 30: 9.0 →	40 Skud 	31: 9.5 ↘ 32: 9.8 ↖ 33: 10.0 ↘ 34: 10.6x ↗ 35: 9.3 ↘ 36: 10.0 ↖ 37: 9.9 ↘ 38: 10.7x → 39: 8.9 ↘ 40: 10.5x ↗
Serie 94.0		Serie 94.0	
Total 274.0		Total 368.0	

<p>Prøve</p>	<p>1: 7.5 ←</p> <p>2: 9.6 ←</p> <p>3: 9.1 ↘</p> <p>4: 8.2 ↗</p> <p>5: 9.7 ↗</p> <p>6: 10.3 →</p> <p>7: 9.4 ←</p> <p>8: 10.0 ↗</p> <p>9: 10.1 ↘</p> <p>10: 8.1 ↘</p>	<p>Prøve</p>		<p>11: 7.6 ↗</p> <p>12: 9.1 ←</p> <p>13: 6.8 ↖</p> <p>14: 9.2 ←</p> <p>15: 8.5 ↗</p> <p>16: 9.9 ←</p> <p>17: 9.3 ←</p> <p>18: 8.6 ↘</p> <p>19: 9.0 ↖</p> <p>20: 10.3 ↗</p>
Serie	89.0	Serie		84.0
Total	0.0	Total		0.0

<p>40 Skud</p>	<p>1: 9.3 ↘</p> <p>2: 8.9 ↘</p> <p>3: 9.0 ↗</p> <p>4: 10.0 ↗</p> <p>5: 9.7 →</p> <p>6: 10.8x ↘</p> <p>7: 8.8 ↘</p> <p>8: 8.7 ↗</p> <p>9: 9.9 ↗</p> <p>10: 8.5 ↘</p>	<p>40 Skud</p>		<p>11: 1.8 ↘</p> <p>12: 9.7 ↗</p> <p>13: 10.0 ↘</p> <p>14: 9.7 ↘</p> <p>15: 9.8 ←</p> <p>16: 9.4 ←</p> <p>17: 8.8 ↗</p> <p>18: 10.2 ↗</p> <p>19: 10.3 ↖</p> <p>20: 8.0 ↗</p>
Serie	88.0	Serie		83.0
Total	88.0	Total		171.0

<p>40 Skud</p>	<p>21: 10.4x ↘</p> <p>22: 9.6 ↘</p> <p>23: 9.3 ←</p> <p>24: 9.4 ↗</p> <p>25: 8.7 ↗</p> <p>26: 9.5 ↘</p> <p>27: 8.5 ↖</p> <p>28: 9.2 ↗</p> <p>29: 9.8 →</p> <p>30: 9.1 ↖</p>	<p>40 Skud</p>		<p>31: 9.2 ←</p> <p>32: 9.2 ↗</p> <p>33: 9.9 ↖</p> <p>34: 8.7 ↖</p> <p>35: 9.5 ↗</p> <p>36: 8.1 ↘</p> <p>37: 8.2 ↘</p> <p>38: 10.1 ←</p> <p>39: 9.0 ↘</p> <p>40: 10.4x ↘</p>
Serie	89.0	Serie		89.0
Total	260.0	Total		349.0

<p>Prøve</p>	<p>1: 10.0 ↓ 2: 9.9 → 3: 9.7 → 4: 10.5x ← 5: 9.4 → 6: 10.1 ← 7: 9.6 ↓ 8: 9.5 ← 9: 10.3 ↓ 10: 8.0 ←</p> <p>Serie 93.0 Total 0.0</p>	<p>Prøve</p>	<p>11: 8.9 ↓ 12: 9.2 ↗ 13: 10.4x ↖ 14: 10.1 ← 15: 10.7x ↗</p> <p>Serie 47.0 Total 0.0</p>
<p>60 Skud</p>	<p>1: 9.8 ← 2: 9.9 ← 3: 9.2 → 4: 10.3 ↓ 5: 9.5 → 6: 10.1 → 7: 8.5 ↗ 8: 9.1 ← 9: 9.9 ↓ 10: 9.3 ↗</p> <p>Serie 91.0 Total 91.0</p>	<p>60 Skud</p>	<p>11: 9.8 ↓ 12: 10.0 ↗ 13: 10.2 ↗ 14: 9.8 ← 15: 7.7 ↗ 16: 9.5 → 17: 10.3 ↗ 18: 10.2 ↗ 19: 10.3 ↑ 20: 9.1 ←</p> <p>Serie 93.0 Total 184.0</p>
<p>60 Skud</p>	<p>21: 8.8 → 22: 10.4x ↓ 23: 7.0 ← 24: 8.4 ← 25: 10.3 ↓ 26: 9.6 ↗ 27: 8.9 ↑ 28: 9.7 ← 29: 10.4x ↖ 30: 9.8 ←</p> <p>Serie 88.0 Total 272.0</p>	<p>60 Skud</p>	<p>31: 8.9 ↑ 32: 9.7 ↖ 33: 9.9 ↓ 34: 9.9 → 35: 7.8 ← 36: 10.8x ↑ 37: 10.9x → 38: 9.7 ← 39: 9.7 ↑ 40: 10.3 ↗</p> <p>Serie 90.0 Total 362.0</p>
<p>60 Skud</p>	<p>41: 9.4 ↗ 42: 9.4 ↗ 43: 10.3 ↗ 44: 8.9 ← 45: 10.3 → 46: 10.0 ← 47: 10.0 ← 48: 10.3 ↑ 49: 9.4 ↑ 50: 8.2 ↗</p> <p>Serie 93.0 Total 455.0</p>	<p>60 Skud</p>	<p>51: 10.2 ← 52: 8.8 ↑ 53: 8.1 ← 54: 9.8 → 55: 8.7 ↑ 56: 10.8x ↓ 57: 9.8 ← 58: 9.3 ↖ 59: 8.6 ← 60: 8.6 ↖</p> <p>Serie 87.0 Total 542.0</p>

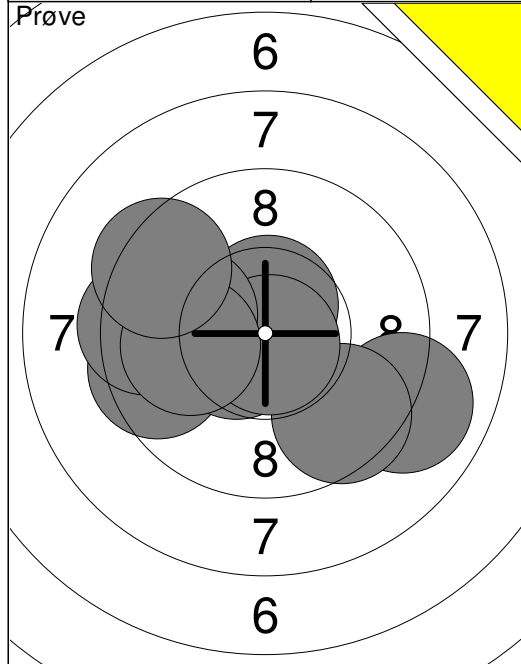

1:	9.5	←
2:	10.5x	↙
3:	10.6x	↑
4:	9.0	→
5:	9.5	↘
6:	10.8x	↘
7:	9.9	←
8:	9.4	←
9:	10.0	←
10:	9.4	↙
Serie		98.6
Total		0.0

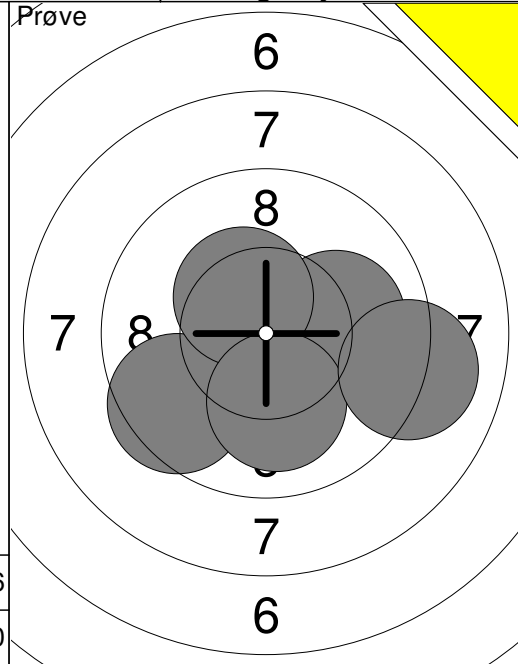

11:	10.0	→
12:	9.5	↙
13:	10.4x	↖
14:	10.1	↘
15:	9.1	→
Serie		49.1
Total		0.0

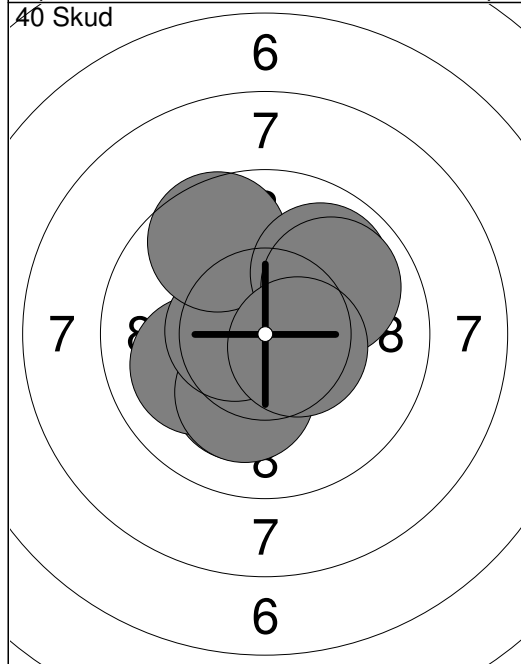

1:	10.8x	↑
2:	10.2x	↘
3:	10.0	↙
4:	10.2x	↘
5:	10.6x	↑
6:	10.6x	←
7:	9.6	↖
8:	9.9	↗
9:	9.9	↗
10:	10.5x	→
Serie		102.3
Total		102.3

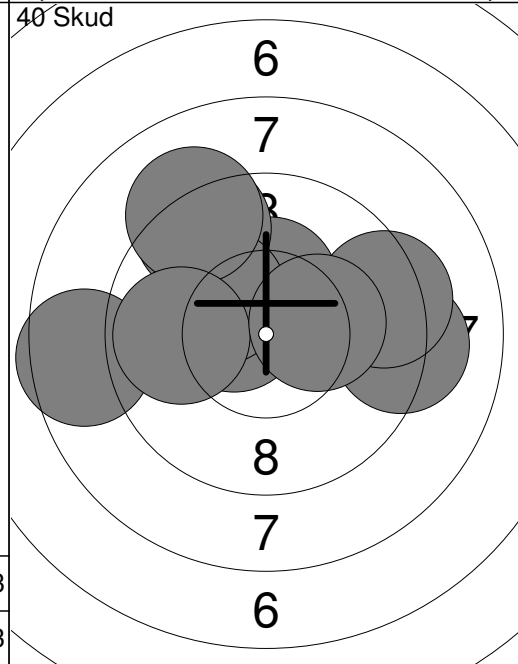

11:	10.5x	↙
12:	10.3x	↑
13:	8.6	←
14:	9.2	→
15:	9.3	↖
16:	10.2x	↙
17:	9.3	→
18:	9.1	↖
19:	9.8	←
20:	10.3x	→
Serie		96.6
Total		198.9

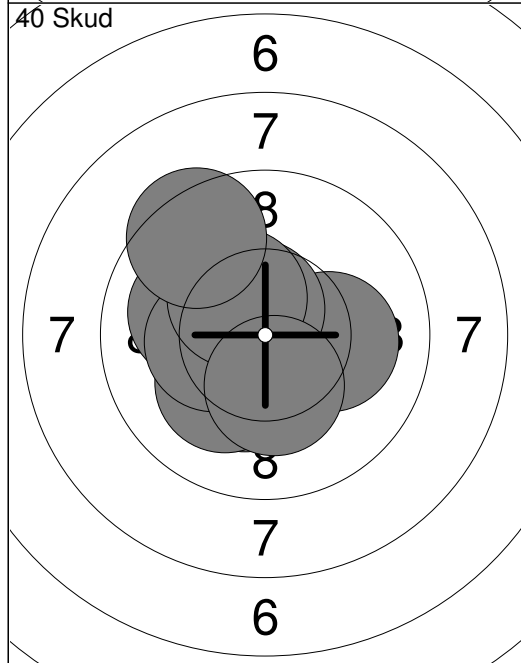

21:	10.1	→
22:	10.6x	↖
23:	10.3x	↙
24:	10.3x	↘
25:	10.0	←
26:	10.2x	↘
27:	10.3x	←
28:	10.4x	↖
29:	9.4	↖
30:	10.3x	↘
Serie		101.9
Total		300.8

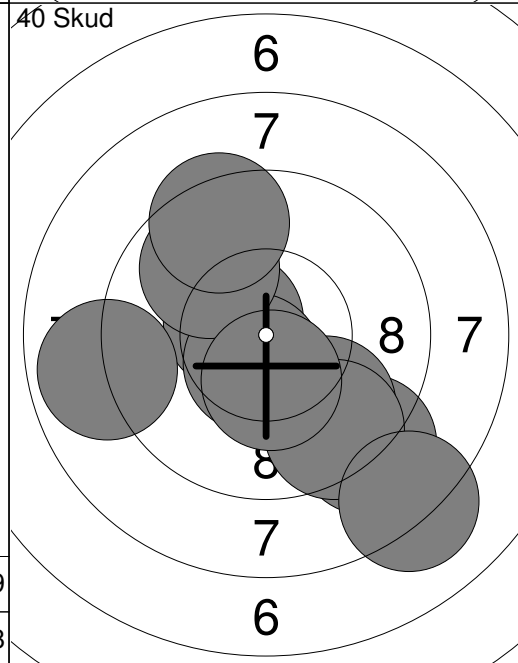

31:	9.1	↘
32:	10.5x	↙
33:	10.6x	↘
34:	9.8	↘
35:	8.9	←
36:	9.5	↘
37:	8.1	↘
38:	9.8	↖
39:	9.4	↖
40:	10.4x	↘
Serie		96.1
Total		396.9

Hold	Skive	Matias Faurbye	
10	11		
10m		Viborg Skytteforening	HJ R
		10 meter stævne	Aalborg Skyttekreds
Prøve 	1: 8.7 ← 2: 9.8 ↗ 3: 10.5x ↗ 5: 9.0 ↗ 6: 10.1 ↗ 7: 9.7 ↗ 8: 9.2 ↗ 9: 9.9 ↗ 10: 9.9 ↘	Prøve 	11: 9.8 ← 12: 9.5 → 13: 9.9 → 14: 7.6 → 15: 10.4x ↗ 16: 10.1 ↗ 17: 10.2x ↓ 18: 9.0 ← 19: 9.7 → 20: 10.0 →
	Serie 86.8 Total 0.0		Serie 96.2 Total 0.0
Prøve 	21: 9.8 → 22: 10.5x ↓ 23: 9.5 ↓ 24: 10.5x → 25: 10.5x ↗ 26: 9.4 ↗ 27: 9.9 ↓ 28: 9.9 ↗ 29: 9.8 ↘	60 Skud 	1: 10.3x ↗ 2: 8.9 → 3: 10.1 ↘ 4: 10.4x ↗ 5: 9.8 ↗ 6: 10.6x ← 7: 10.8x ← 8: 10.4x ↘ 9: 10.5x ← 10: 9.4 ↓
	Serie 89.8 Total 0.0		Serie 101.2 Total 101.2
60 Skud 	11: 9.9 → 12: 10.2x ↓ 13: 9.8 ← 14: 9.8 ↘ 15: 9.6 ↘ 16: 10.4x ↓ 17: 10.5x ↓ 18: 8.7 ← 19: 10.7x ← 20: 9.2 ↓	60 Skud 	21: 10.5x ↗ 22: 9.7 ← 23: 9.8 ↓ 24: 10.6x ← 25: 10.3x ← 26: 10.5x ↑ 27: 10.2x ↓ 28: 8.4 ← 29: 10.8x ↓ 30: 9.6 →
	Serie 98.8 Total 200.0		Serie 100.4 Total 300.4
60 Skud 	31: 9.7 → 32: 9.4 ↗ 33: 9.3 ↗ 34: 9.3 ↗ 35: 9.6 ↘ 36: 10.3x → 37: 9.5 ↗ 38: 10.6x ← 39: 9.2 ← 40: 9.5 ↗	60 Skud 	41: 10.5x ↓ 42: 10.7x → 43: 10.5x → 44: 9.4 ↗ 45: 10.4x ↗ 46: 9.7 ↗ 47: 9.8 ↗ 48: 9.0 ↑ 49: 10.3x ↗ 50: 10.8x ↑
	Serie 96.4 Total 396.8		Serie 101.1 Total 497.9
60 Skud 	51: 9.8 ↗ 52: 10.4x ↑ 53: 9.5 ↗ 54: 9.5 ↗ 55: 9.0 → 56: 9.6 ↗ 57: 10.3x ↑ 58: 7.7 → 59: 9.8 ↗ 60: 10.1 ←		
	Serie 95.7 Total 593.6		

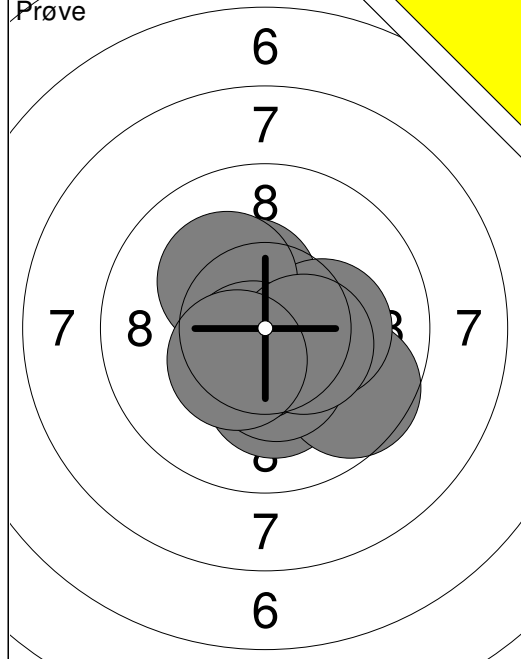

1:	10.5x →
2:	10.2x ↓
3:	9.6 →
4:	10.4x ↓
5:	10.4x ↗
6:	10.2x →
7:	10.2x ↘
8:	10.6x ↓
9:	10.4x →
10:	10.4x ↙
Serie 102.9	
Total 0.0	

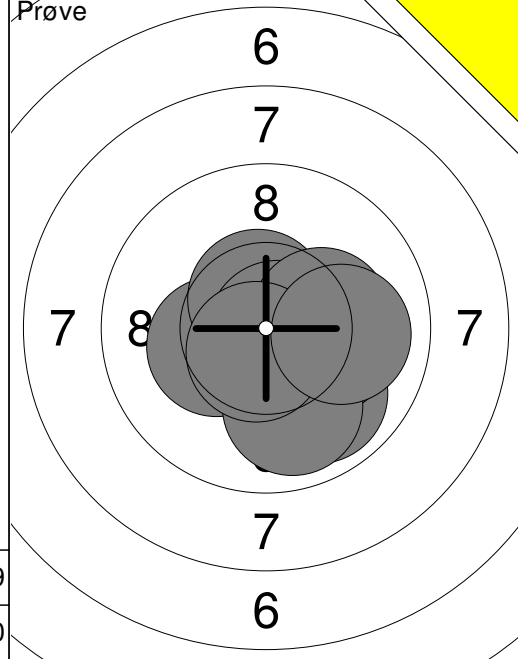

11:	10.3x ↙
12:	9.9 ↓
13:	10.6x ↗
14:	10.8x →
15:	10.2x →
16:	10.2x →
17:	9.9 ↓
18:	10.6x ↓
19:	10.0 →
Serie 92.5	
Total 0.0	

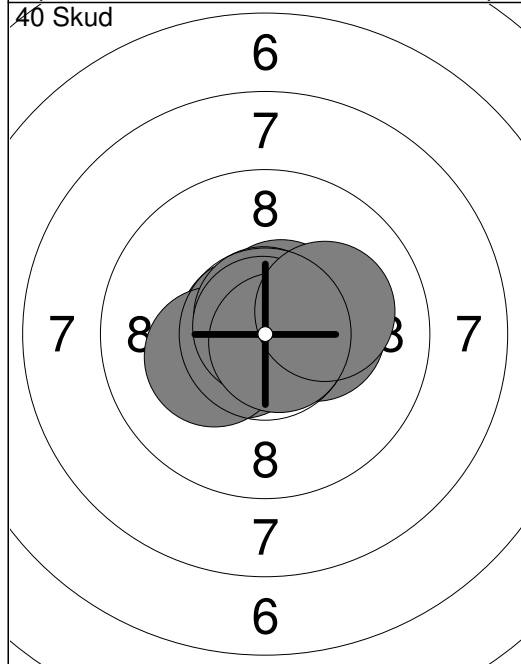

1:	10.3x →
2:	10.6x ↙
3:	10.8x ↘
4:	10.7x ↙
5:	10.6x ↗
6:	10.2x ↙
7:	10.7x ↗
8:	10.9x ↗
9:	10.8x ↘
10:	10.1 →
Serie 105.7	
Total 105.7	

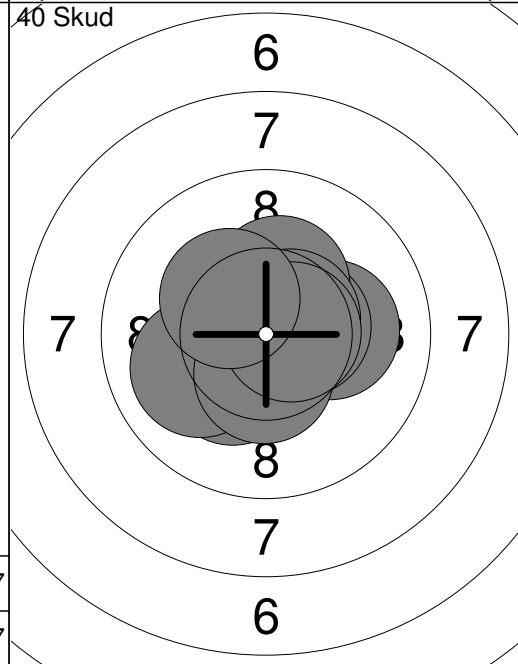

11:	10.8x ↙
12:	10.1 →
13:	10.3x ↙
14:	10.5x →
15:	10.3x ↗
16:	10.6x ↗
17:	10.0 ↙
18:	10.4x ↓
19:	10.6x →
20:	10.3x ↘
Serie 103.9	
Total 209.6	

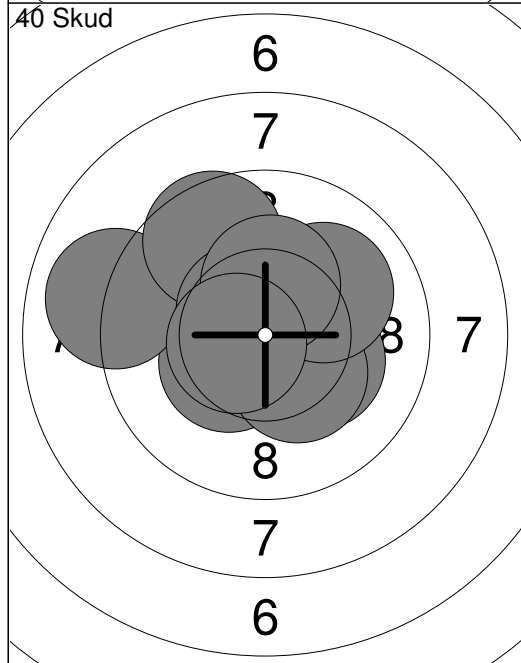

21:	10.2x →
22:	10.4x ↙
23:	10.3x ↗
24:	9.0 ↙
25:	10.3x ↘
26:	9.6 ↗
27:	10.6x ↘
28:	10.0 ↗
29:	10.3x ↗
30:	10.6x ↙
Serie 101.3	
Total 310.9	

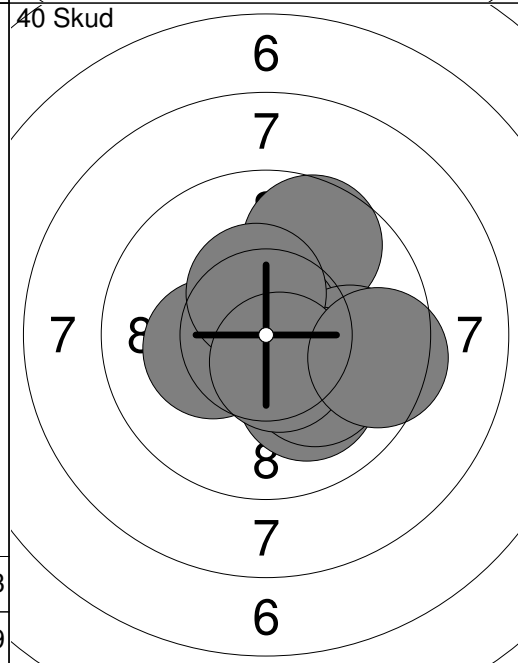

31:	10.6x ↙
32:	9.7 ↗
33:	10.1 ↓
34:	10.8x ↗
35:	9.8 →
36:	10.3x ↙
37:	10.1 ↓
38:	10.4x ↗
39:	10.6x ↓
40:	9.5 →
Serie 101.9	
Total 412.8	



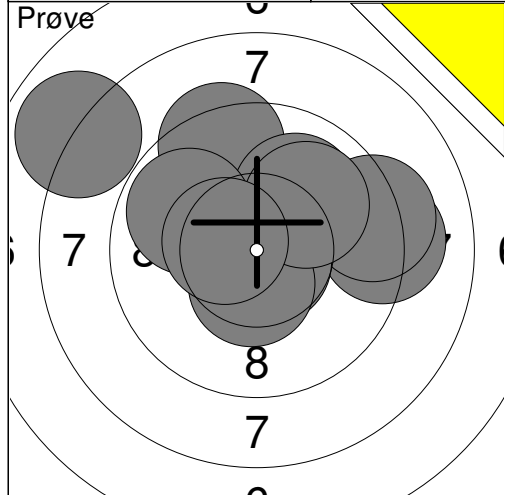

1:	9.4	↗
2:	10.0	↗
3:	9.2	→
4:	9.2	→
5:	10.7x	↘
6:	10.5x	↘
7:	10.0	↗
8:	9.8	↖
9:	7.9	↖
10:	10.5x	←
Serie		97.2
Total		0.0

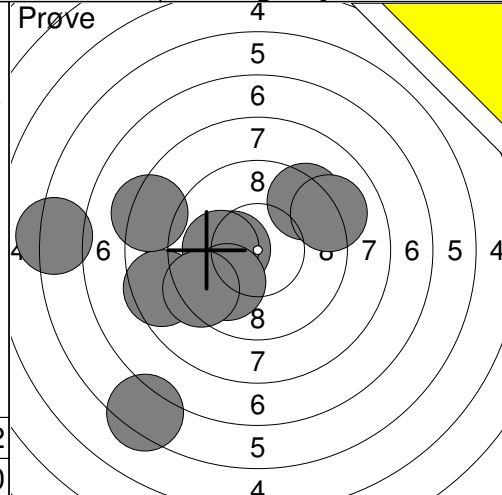

11:	10.3x	←
12:	6.3	↘
13:	9.4	↗
14:	8.5	←
15:	10.1	←
16:	6.2	←
17:	9.1	↗
18:	9.9	↘
19:	9.3	↖
20:	8.3	←
Serie		87.4
Total		0.0

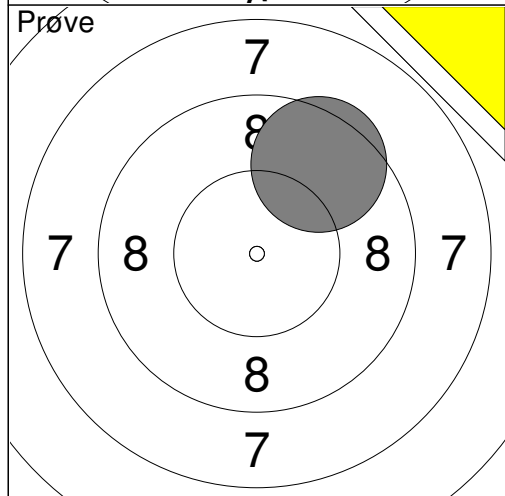

21:	9.5	↗
Serie		9.5
Total		0.0

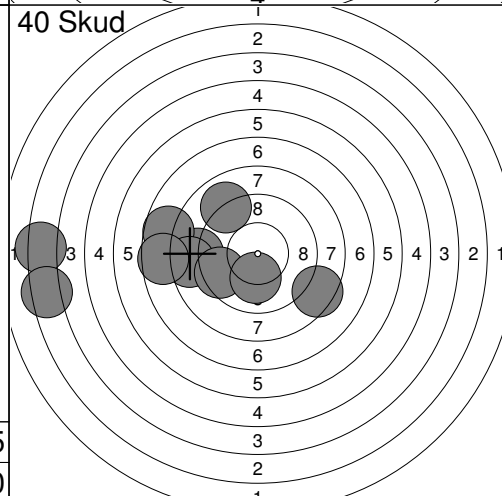

1:	8.5	↘
2:	9.0	↗
3:	8.8	←
4:	7.7	←
5:	3.3	←
6:	8.5	←
7:	9.5	←
8:	7.6	←
9:	3.4	←
10:	10.1	↓
Serie		76.4
Total		76.4

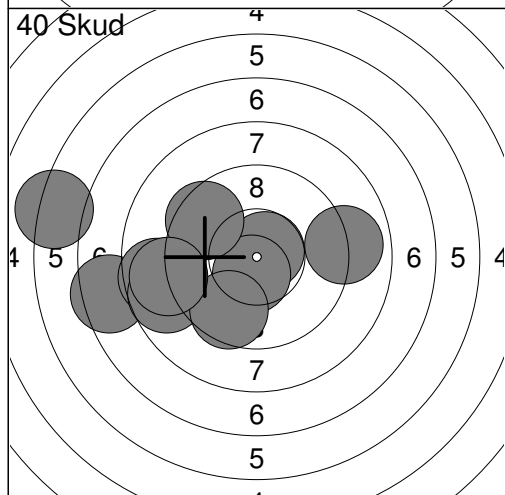

11:	7.5	←
12:	10.7x	↗
13:	10.5x	↘
14:	6.2	←
15:	9.5	↗
16:	8.6	←
17:	8.7	←
18:	9.6	↘
19:	8.9	→
20:	8.9	←
Serie		89.1
Total		165.5

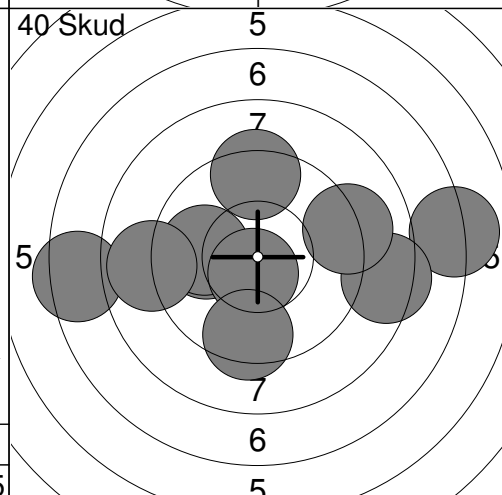

21:	7.1	→
22:	9.9	←
23:	9.3	↑
24:	9.9	←
25:	10.6x	↘
26:	7.4	←
27:	8.4	→
28:	8.9	←
29:	9.1	→
30:	9.4	↓
Serie		90.0
Total		255.5

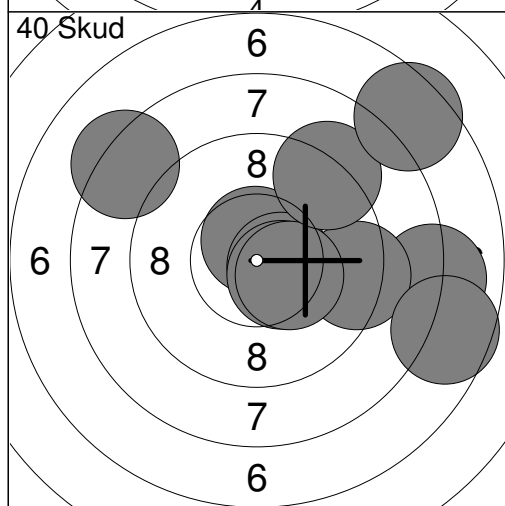

31:	8.0	→
32:	10.6x	↑
33:	10.5x	→
34:	9.3	→
35:	7.6	→
36:	10.5x	↘
37:	8.2	↗
38:	10.4x	↘
39:	9.1	↗
40:	7.5	↗
Serie		91.7
Total		347.2

Prøve 	1: 9.4 ↓ 2: 9.0 ← 3: 9.7 ↓ 4: 10.3x ↑ 5: 9.6 ↑ 6: 10.0 ↓ 7: 9.6 ← 8: 9.5 ← 9: 8.6 ← 10: 8.6 ← <hr/> Serie 94.3 Total 0.0	Prøve 	11: 9.1 ↘ 12: 9.5 ← 13: 9.1 ↖ 14: 6.8 ↙ 15: 8.9 ← 16: 8.8 ← <hr/> Serie 52.2 Total 0.0
-----------	-----------------------------------------------------------------------------------------------------------------------------------------------------------	-----------	-------------------------------------------------------------------------------------------------------------

60 Skud 	1: 10.5x ← 2: 9.3 ← 3: 9.8 ← 4: 6.7 ← 5: 9.7 ↗ 6: 9.9 ↖ 7: 8.6 ← 8: 9.8 ← 9: 9.6 ← 10: 10.7x ← <hr/> Serie 94.6 Total 94.6	60 Skud 	11: 9.7 ↓ 12: 9.4 ← 13: 10.0 ↗ 14: 9.4 ↑ 15: 9.1 ← 16: 7.8 ↖ 17: 9.5 → 18: 8.3 ← 19: 9.9 → 20: 8.1 ↗ <hr/> Serie 91.2 Total 185.8
-------------	-------------------------------------------------------------------------------------------------------------------------------------------------------------	-------------	--------------------------------------------------------------------------------------------------------------------------------------------------------------------

60 Skud 	21: 8.9 ← 22: 10.3x ↘ 23: 10.0 ↗ 24: 8.2 → 25: 9.1 → 26: 10.5x ↓ 27: 8.9 ← 28: 9.3 ↗ 29: 9.4 ↗ 30: 9.9 ← <hr/> Serie 94.5 Total 280.3	60 Skud 	31: 7.9 ← 32: 9.2 ↗ 33: 10.8x ↗ 34: 8.4 ↖ 35: 9.6 ↑ 36: 9.5 ← 37: 8.6 ↖ 38: 8.9 ← 39: 8.5 ↖ 40: 10.2x ↗ <hr/> Serie 91.6 Total 371.9
-------------	------------------------------------------------------------------------------------------------------------------------------------------------------------------------	-------------	-----------------------------------------------------------------------------------------------------------------------------------------------------------------------

60 Skud 	41: 10.6x ↑ 42: 9.9 ↗ 43: 8.8 ← 44: 9.4 → 45: 8.3 ↗ 46: 8.5 ↗ 47: 9.7 ← 48: 8.5 ↗ 49: 8.1 ↗ 50: 10.5x ↑ <hr/> Serie 92.3 Total 464.2	60 Skud 	51: 9.9 → 52: 9.5 ← 53: 9.2 ↗ 54: 9.7 ← 55: 9.4 ↗ 56: 9.1 ↗ 57: 9.0 ← 58: 9.0 ↗ 59: 9.5 ↗ 60: 10.5x ↘ <hr/> Serie 94.8 Total 559.0
-------------	-----------------------------------------------------------------------------------------------------------------------------------------------------------------------	-------------	---------------------------------------------------------------------------------------------------------------------------------------------------------------------

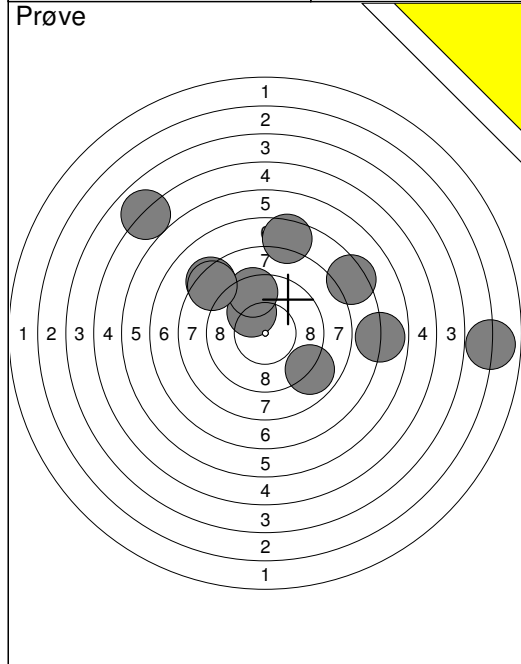

1: 6.9	→
2: 7.3	↗
3: 8.9	↘
4: 8.3	↗
5: 5.0	↗
6: 10.1	↗
7: 9.4	↗
8: 8.4	↗
9: 2.9	→
10: 7.5	↑
<b>Serie 74.7</b>	
<b>Total 0.0</b>	

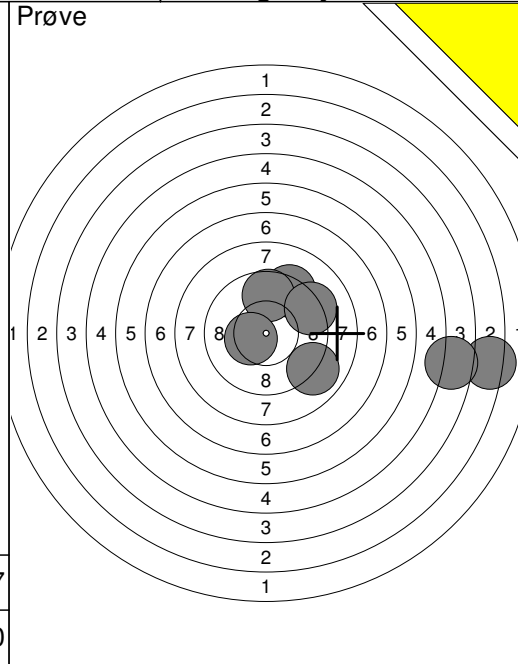

11: 3.3	→
12: 9.3	↗
13: 9.0	↘
14: 4.6	→
15: 9.7	↑
16: 9.2	↗
17: 10.4x	↙
<b>Serie 55.5</b>	
<b>Total 0.0</b>	

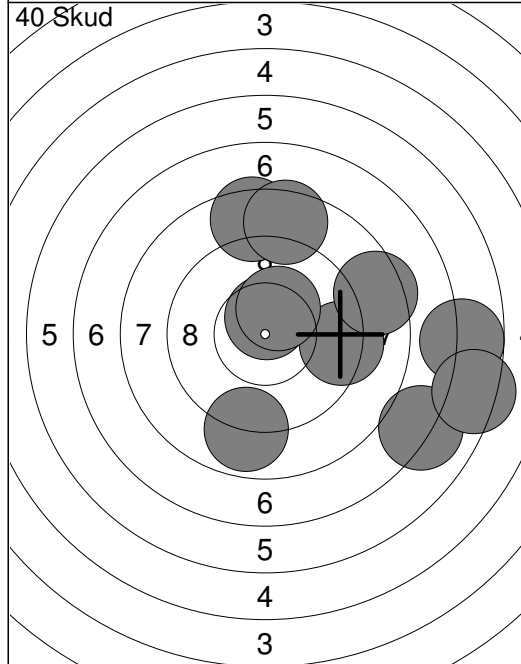

1: 8.5	↑
2: 7.1	↘
3: 8.5	↑
4: 10.6x	↑
5: 9.3	→
6: 8.9	↓
7: 6.7	→
8: 8.4	→
9: 10.3x	↗
10: 6.3	→
<b>Serie 84.6</b>	
<b>Total 84.6</b>	

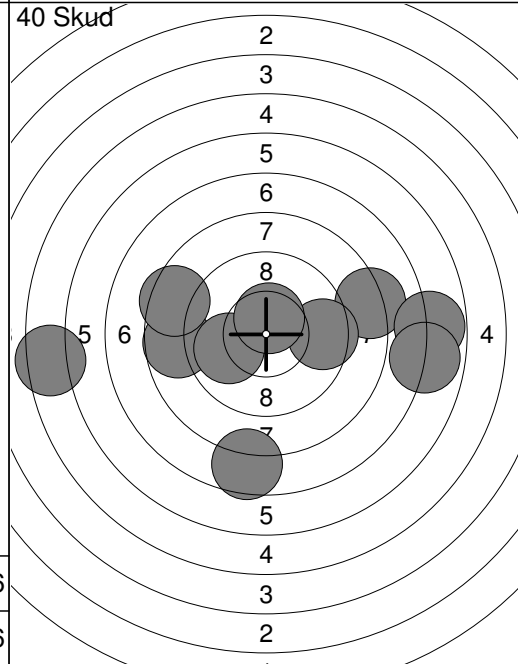

11: 8.2	→
12: 6.8	→
13: 6.9	→
14: 8.7	←
15: 9.5	→
16: 9.9	←
17: 5.4	←
18: 10.5x	↑
19: 8.5	←
20: 7.6	↓
<b>Serie 82.0</b>	
<b>Total 166.6</b>	

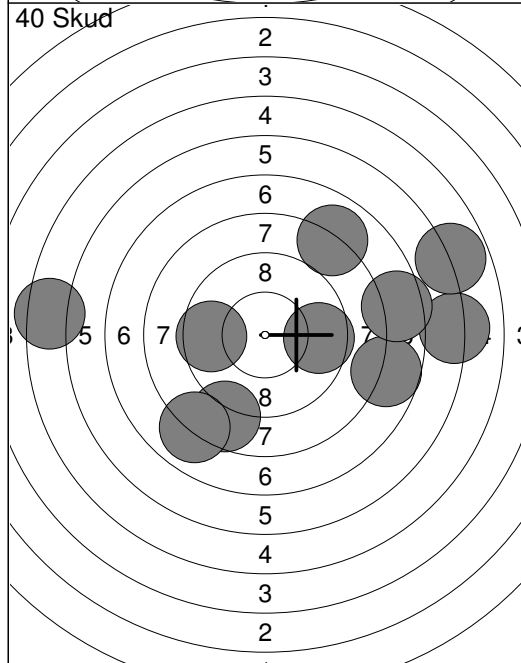

21: 6.1	→
22: 8.6	↘
23: 9.6	←
24: 7.7	→
25: 9.6	→
26: 5.4	←
27: 7.5	→
28: 8.0	↘
29: 8.0	↗
30: 5.8	→
<b>Serie 76.3</b>	
<b>Total 242.9</b>	

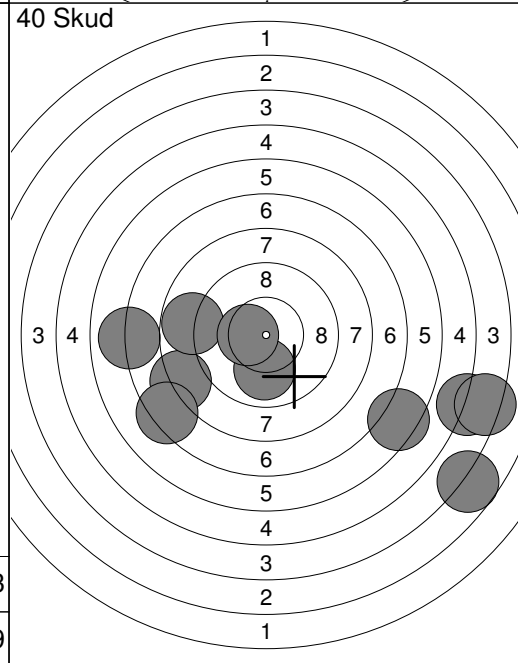

31: 6.4	↘
32: 8.1	←
33: 3.7	↘
34: 7.3	↙
35: 8.8	←
36: 4.8	→
37: 10.0	↓
38: 4.3	→
39: 7.0	←
40: 10.4x	↙
<b>Serie 70.8</b>	
<b>Total 313.7</b>	