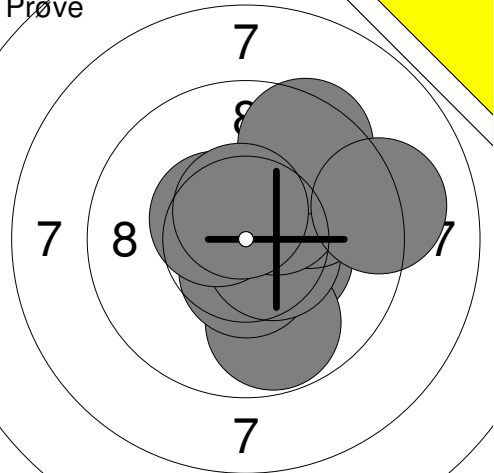
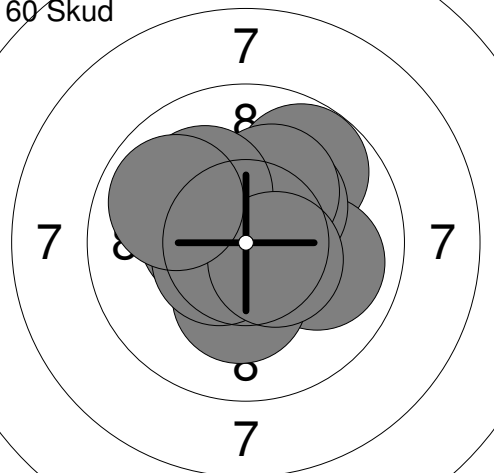
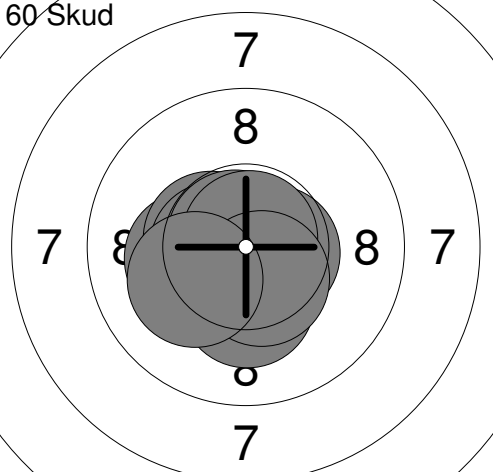
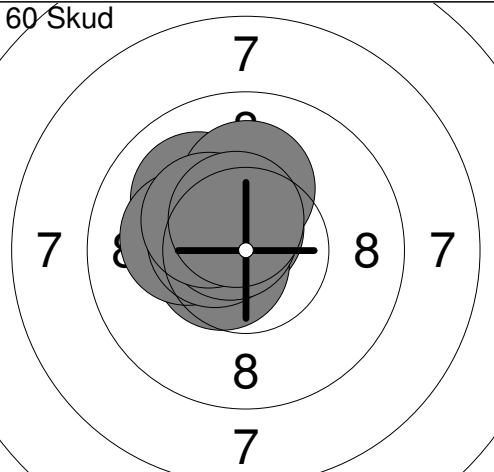
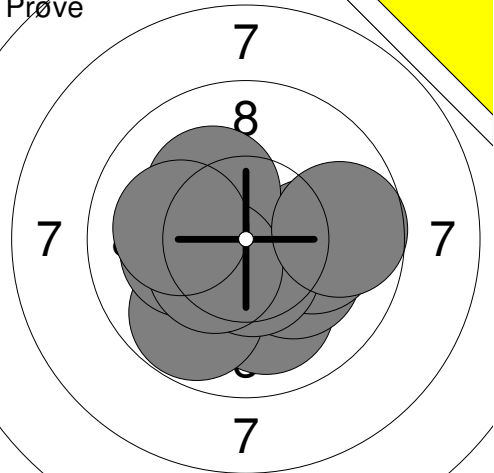
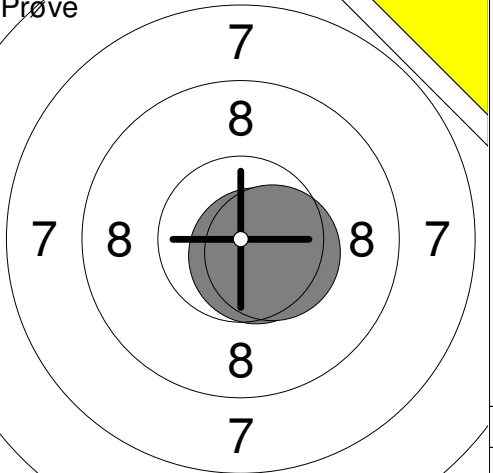
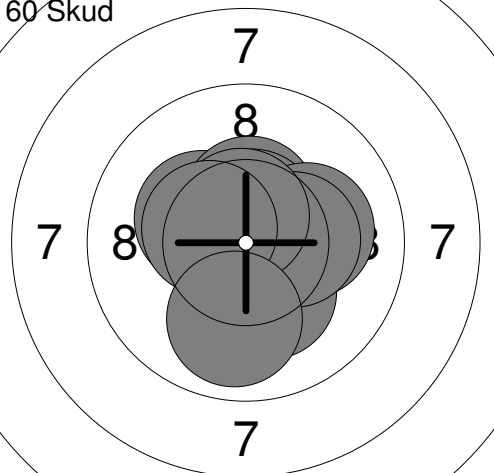
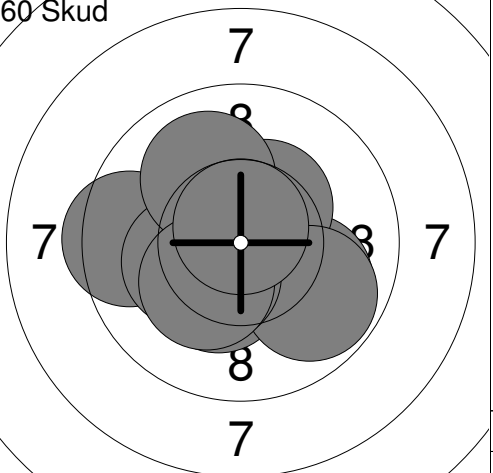
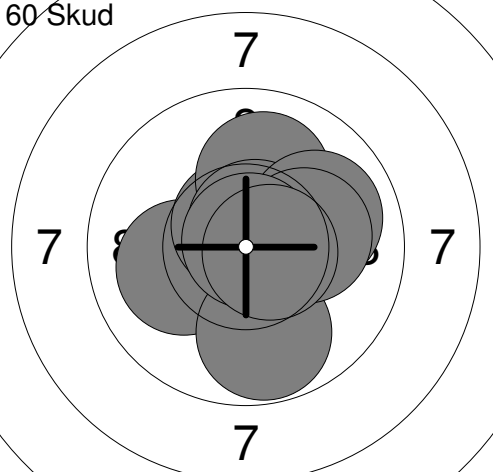
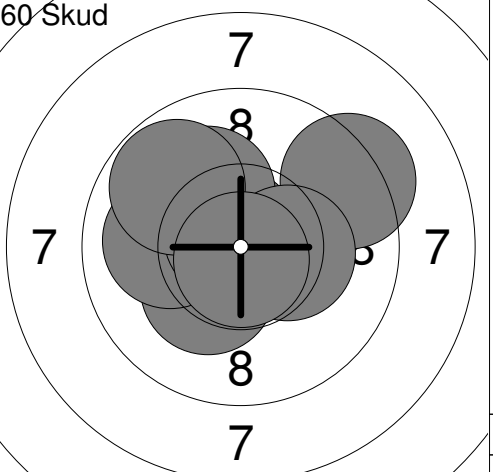
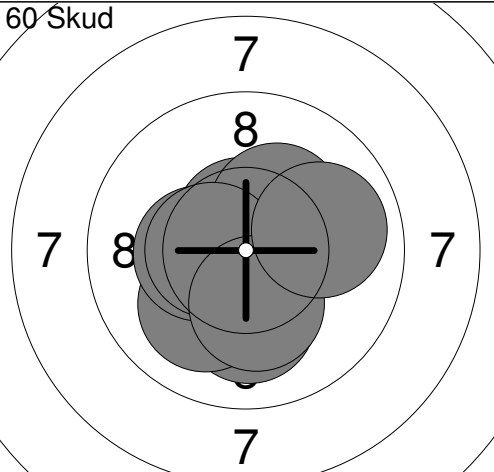
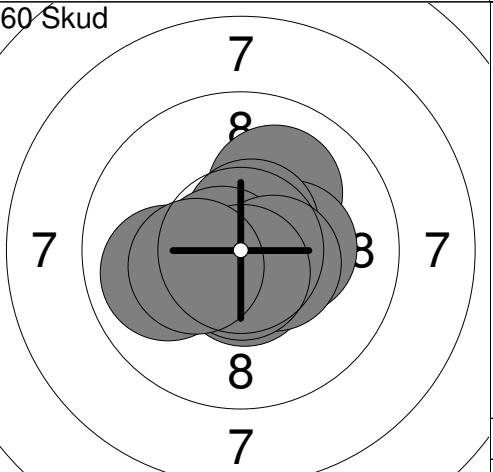
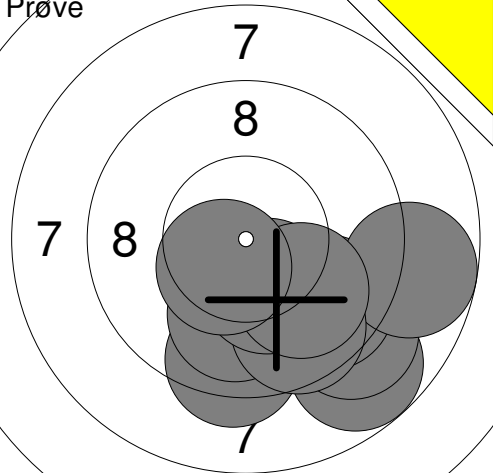
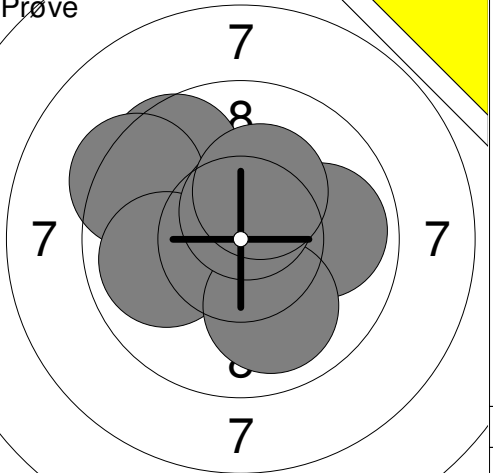
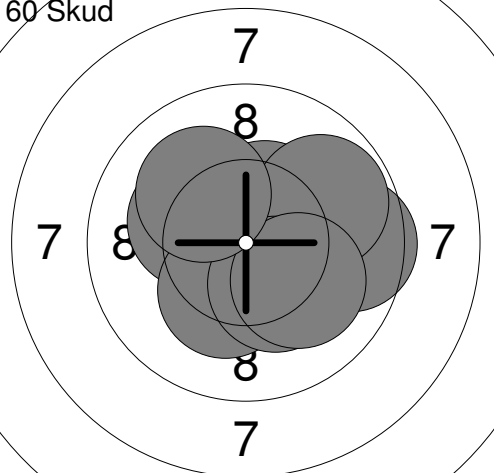
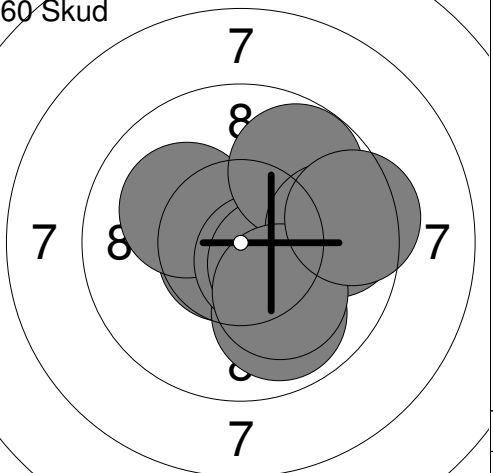
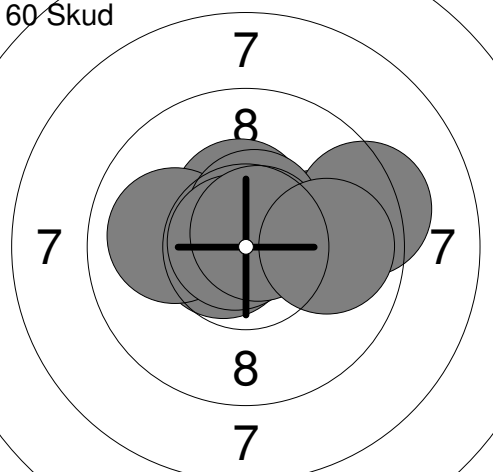
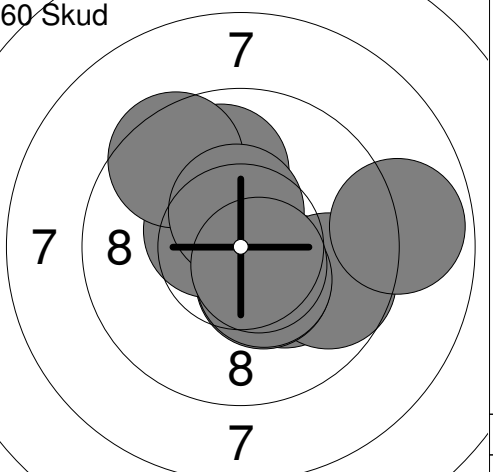
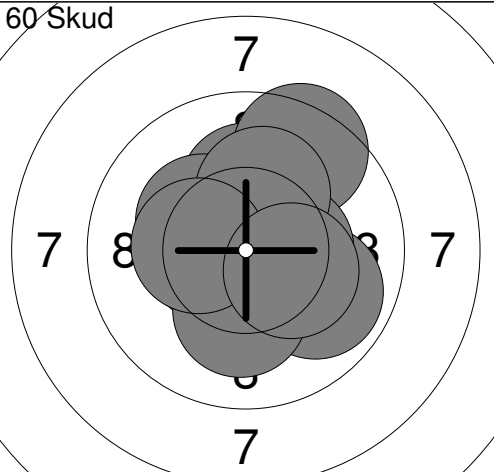
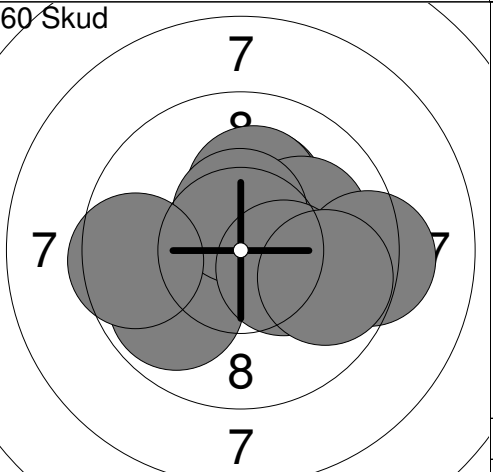
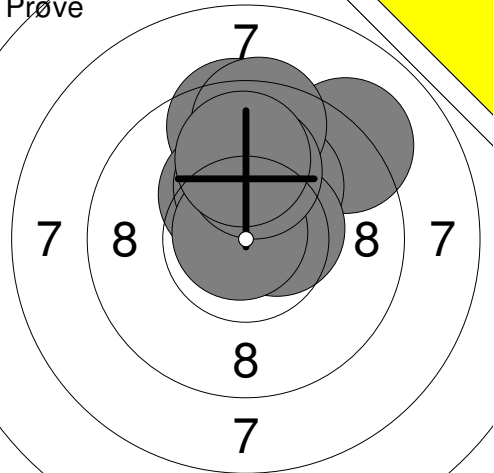
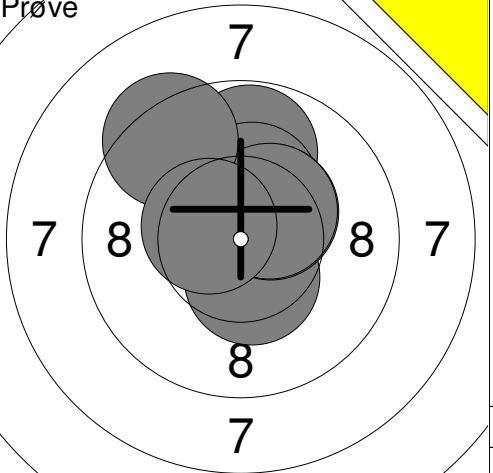
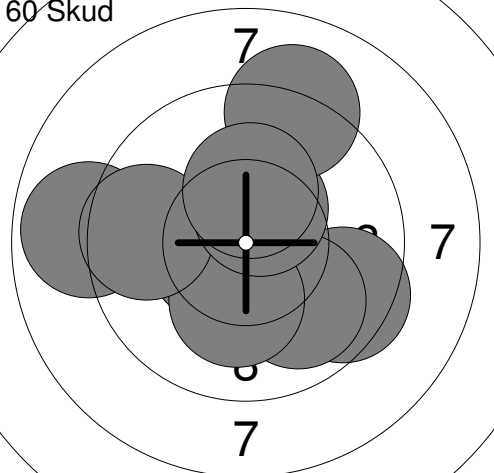
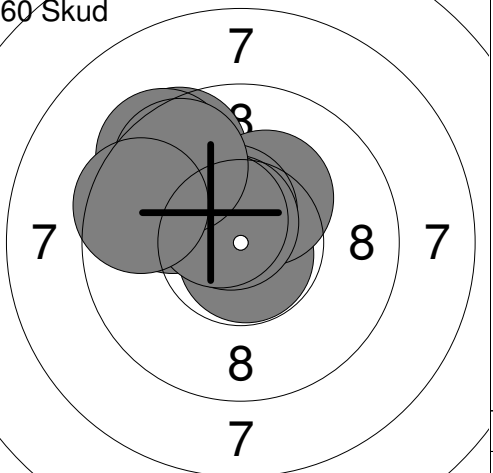
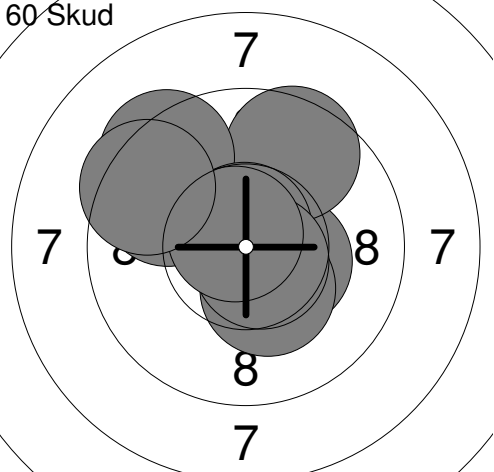
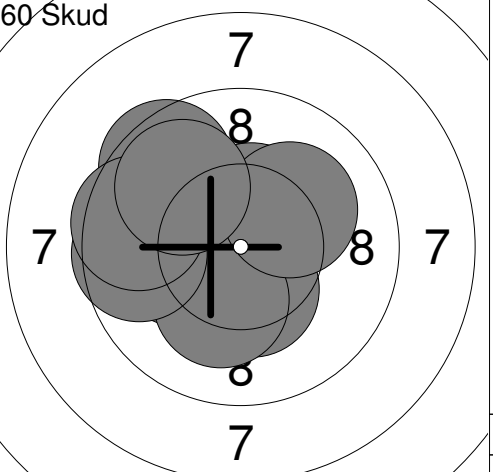
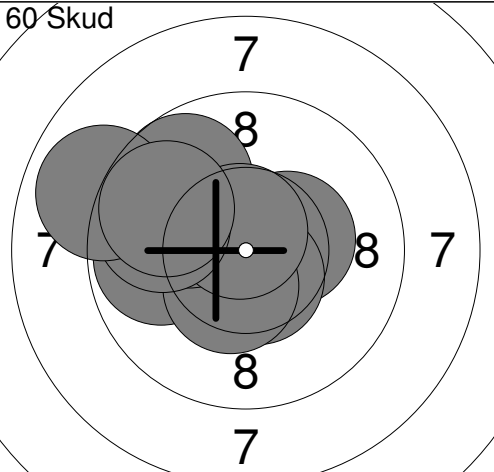
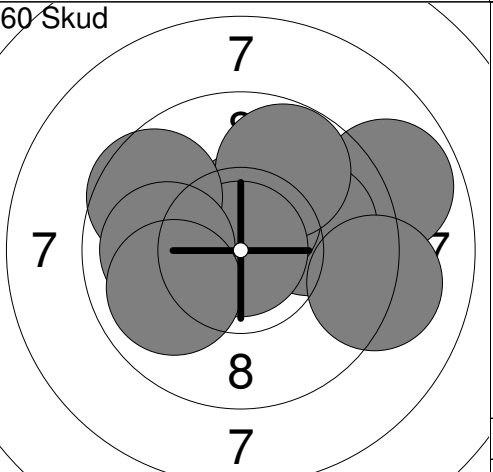

Hold	Skive	Lars Ørum	
1	1		
10m	Aalborg Skyttekreds	H	R
19.01.2013	DIF 4. runde	Aalborg Skyttekreds	
Prøve		1: *10.4 → 2: 9.8 ↓ 3: *10.5 ↓ 4: *10.5 → 5: 10.0 → 6: *10.4 ↗ 7: *10.5 ↗ 8: 9.5 ↗ 9: 9.1 → 10: *10.6 ↑	11: 9.7 → 12: 10.0 → 13: *10.6 ↓
		Serie 97.0	Serie 29.0
		Total 0.0	Total 0.0
60 Skud		1: 9.8 ↗ 2: 10.0 → 3: *10.3 ↗ 4: *10.2 ↗ 5: *10.4 ← 6: *10.2 ↓ 7: 10.1 ↗ 8: *10.5 ← 9: *10.5 ↓ 10: 9.9 ↗	11: *10.5 ← 12: *10.2 ← 13: *10.6 → 14: 9.8 ↗ 15: 10.1 → 16: *10.5 ↓ 17: *10.3 → 18: *10.6 ← 19: *10.3 ↖ 20: *10.3 ↑
		Serie 98.0	Serie 99.0
		Total 98.0	Total 197.0
60 Skud		21: *10.5 ↓ 22: *10.2 ← 23: *10.6 → 24: *10.5 ← 25: *10.2 ↓ 26: *10.6 ← 27: *10.8 ↗ 28: *10.8 ↗ 29: *10.5 ↓ 30: 10.1 ←	31: *10.6 → 32: *10.5 → 33: *10.6 ← 34: *10.5 ↖ 35: *10.5 ← 36: 9.3 ↗ 37: *10.2 ← 38: *10.5 ↓ 39: *10.7 ↓ 40: *10.6 ↓
		Serie 100.0	Serie 99.0
		Total 297.0	Total 396.0
60 Skud		41: *10.2 ↗ 42: 10.0 ↗ 43: *10.6 ↗ 44: *10.6 ← 45: *10.2 ← 46: *10.5 ← 47: 10.1 ↑ 48: *10.6 ↗ 49: *10.3 ↗ 50: *10.5 ↑	51: *10.6 ↑ 52: 9.7 ↓ 53: *10.5 → 54: 10.1 ↗ 55: *10.4 ← 56: *10.2 → 57: *10.4 ↓ 58: *10.3 ↑ 59: *10.6 → 60: 10.0 →
		Serie 100.0	Serie 99.0
		Total 496.0	Total 595.0

Hold	Skive	Camilla B. Nielsen			
1	2	Særslev Skytteforening		DJ	R
10m		DIF 4. runde		Aalborg Skyttekreds	
19.01.2013					
Prøve		1: 10.0 ↘ 2: *10.2 ↘ 3: 10.1 → 4: 9.8 ↘ 5: *10.2 ← 6: *10.6 ↘ 7: *10.2 ↗ 8: *10.4 ↘ 9: 10.1 ← 10: 9.7 →	Prøve		11: *10.6 ↘ 12: *10.5 →
		Serie 98.0		Serie 20.0	
		Total 0.0		Total 0.0	
60 Skud		1: *10.3 ↖ 2: *10.4 → 3: *10.4 ↑ 4: *10.6 ↑ 5: *10.2 ↘ 6: 10.1 → 7: *10.3 → 8: *10.6 ↑ 9: *10.4 ↖ 10: 9.9 ↘	60 Skud		11: 10.0 → 12: *10.3 ↘ 13: *10.4 ↗ 14: 9.8 ↘ 15: 9.5 ← 16: *10.2 ← 17: *10.4 ↘ 18: 10.0 ↗ 19: *10.3 ↘ 20: *10.7 ↑
		Serie 99.0		Serie 98.0	
		Total 99.0		Total 197.0	
60 Skud		21: 10.1 ← 22: *10.8 ↗ 23: *10.6 ↗ 24: 10.0 ↑ 25: *10.7 ↗ 26: 10.0 → 27: 9.8 ↘ 28: *10.2 → 29: *10.9 ↗ 30: *10.6 →	60 Skud		31: *10.2 ↖ 32: *10.4 ← 33: *10.3 ↘ 34: 10.0 ← 35: *10.7 ↗ 36: 9.3 ↗ 37: 10.1 ↗ 38: *10.3 → 39: 9.8 ↗ 40: *10.8 ↘
		Serie 99.0		Serie 98.0	
		Total 296.0		Total 394.0	
60 Skud		41: *10.7 ↖ 42: 10.1 ↘ 43: 10.1 ↘ 44: *10.6 ↑ 45: *10.4 ← 46: *10.7 ↘ 47: *10.3 ↗ 48: *10.5 ← 49: *10.2 ↘ 50: 9.9 →	60 Skud		51: *10.9 ↑ 52: 9.9 ← 53: 10.1 ↗ 54: *10.3 → 55: *10.6 ↗ 56: *10.7 ← 57: *10.6 ↘ 58: *10.5 → 59: *10.7 ↘ 60: *10.3 ←
		Serie 99.0		Serie 99.0	
		Total 493.0		Total 592.0	

Hold	Skive	Kristinna Olsen	
1	3		
10m	Aalborg Skyttekreds	DJ	R
19.01.2013	DIF 4. runde	Aalborg Skyttekreds	
Prøve		1: 9.4 ↓ 2: 8.8 ↓ 3: 10.0 ↓ 4: 9.1 ↓ 5: 9.6 ↓ 6: 8.7 → 7: 9.6 ↓ 8: *10.3 ↓ 9: 10.0 ↓ 10: *10.5 ↓ Serie 92.0 Total 0.0	Prøve  11: 9.9 → 12: *10.2 ↗ 13: 9.6 ↗ 14: 9.4 ↗ 15: 9.9 ← 16: 10.0 ↓ 17: *10.6 ↑ 18: *10.3 ↑ Serie 76.0 Total 0.0
60 Skud		1: *10.2 ← 2: *10.6 ↓ 3: 9.6 → 4: *10.3 ↓ 5: *10.4 ↗ 6: 9.8 → 7: *10.3 ↓ 8: *10.3 ↓ 9: 10.1 ↓ 10: 10.1 ↗ Serie 98.0 Total 98.0	60 Skud  11: *10.8 → 12: *10.7 ← 13: 9.9 ↓ 14: 10.1 ↗ 15: *10.6 ↓ 16: *10.4 ↓ 17: 9.8 ↗ 18: 9.7 → 19: 10.1 ↓ 20: 9.4 → Serie 96.0 Total 194.0
60 Skud		21: 10.0 → 22: *10.7 ↑ 23: *10.4 ↑ 24: *10.6 ← 25: 10.0 ← 26: 9.3 → 27: *10.5 ↑ 28: *10.8 ↖ 29: *10.7 ↗ 30: 9.9 → Serie 98.0 Total 292.0	60 Skud  31: *10.2 ↓ 32: 9.7 → 33: *10.4 ↓ 34: *10.5 ↗ 35: 9.9 ↑ 36: 8.9 → 37: 9.5 ↗ 38: *10.5 ↑ 39: *10.4 ↓ 40: *10.6 ↓ Serie 95.0 Total 387.0
60 Skud		41: *10.2 ↑ 42: *10.5 ← 43: 9.9 ↓ 44: *10.2 ↓ 45: 9.5 ↗ 46: *10.3 ↗ 47: *10.4 → 48: *10.2 ↑ 49: *10.3 ← 50: *10.3 ↓ Serie 98.0 Total 485.0	60 Skud  51: *10.2 ↑ 52: *10.2 ↑ 53: 10.1 → 54: *10.6 ← 55: 9.9 ↖ 56: 9.3 → 57: *10.5 ↑ 58: *10.3 ↓ 59: 9.6 ← 60: 9.8 → Serie 96.0 Total 581.0

Hold	Skive	Rasmus Ørtoft	
1	4		
10m	Særslev Skytteforening	H	R
19.01.2013	DIF 4. runde	Aalborg Skyttekreds	
Prøve		1: 9.5 ↑ 2: *10.3 ↗ 3: 9.1 ↗ 4: *10.2 ↑ 5: 10.1 ↗ 6: *10.5 → 7: 9.4 ↑ 8: *10.8 ↗ 9: 10.0 ↑ 10: 9.9 ↑ Serie 96.0 Total 0.0	Prøve  11: 9.8 ↑ 12: *10.3 ↑ 13: *10.4 ↓ 14: *10.4 ↗ 15: *10.4 ↗ 16: 9.4 ↗ 17: *10.5 ↖ Serie 68.0 Total 0.0
60 Skud		1: 8.9 ← 2: 9.5 ↘ 3: *10.8 ↑ 4: *10.5 ← 5: 9.9 ↘ 6: *10.2 ↓ 7: 9.6 ← 8: *10.5 ↑ 9: 9.1 ↑ 10: *10.3 ↑ Serie 94.0 Total 94.0	60 Skud  11: *10.8 ↓ 12: 9.5 ↗ 13: 9.4 ↗ 14: *10.3 ↑ 15: *10.5 ↑ 16: *10.6 ↗ 17: 9.9 ↗ 18: *10.5 ↗ 19: 9.7 ↗ 20: 9.5 ↖ Serie 95.0 Total 189.0
60 Skud		21: *10.7 ↗ 22: *10.4 → 23: *10.3 ↓ 24: 9.6 ↗ 25: 9.7 ↗ 26: 9.4 ↗ 27: *10.7 ↑ 28: *10.7 ↓ 29: *10.7 ↗ 30: 9.4 ↗ Serie 96.0 Total 285.0	60 Skud  31: 9.5 ↗ 32: *10.4 ↓ 33: 10.0 ↗ 34: *10.5 ↑ 35: 10.1 ← 36: *10.2 ↓ 37: 10.1 ↗ 38: 9.6 ← 39: 9.6 ← 40: 9.8 ↗ Serie 96.0 Total 381.0
60 Skud		41: *10.4 → 42: 9.8 ← 43: *10.6 ↓ 44: *10.4 ↓ 45: 10.1 ↗ 46: 9.7 ↗ 47: *10.7 ↗ 48: 9.8 ← 49: 8.9 ← 50: 9.8 ↗ Serie 94.0 Total 475.0	60 Skud  51: 8.9 → 52: 10.0 → 53: *10.5 ↑ 54: 9.8 ↗ 55: 10.1 ← 56: *10.9 ↑ 57: 9.6 ↗ 58: 10.0 ← 59: 9.9 ↖ 60: 9.1 → Serie 94.0 Total 569.0

<p>Prøve</p>	<p>1: 8.2 →</p> <p>2: 9.6 →</p> <p>3: 10.1 ↘</p> <p>4: *10.6 ←</p> <p>5: *10.3 ←</p> <p>6: 8.1 ↘</p> <p>7: *10.9 ←</p> <p>8: *10.6 ↘</p> <p>9: 10.0 ↘</p> <p>10: *10.5 ↘</p>	<p>Prøve</p>	<p>11: *10.4 →</p> <p>12: *10.7 ↗</p> <p>13: *10.8 ↗</p> <p>14: 9.7 ↗</p> <p>15: 9.0 ↗</p> <p>16: 9.6 ←</p> <p>17: *10.3 ↗</p>
Serie	95.0	Serie	67.0
Total	0.0	Total	0.0

<p>60 Skud</p>	<p>1: *10.4 ↗</p> <p>2: *10.6 ↗</p> <p>3: *10.2 ←</p> <p>4: 10.0 ←</p> <p>5: *10.2 ↗</p> <p>6: 9.7 ↗</p> <p>7: 8.6 ←</p> <p>8: 10.1 ↗</p> <p>9: 9.4 ↗</p> <p>10: 9.5 →</p>	<p>60 Skud</p>	<p>11: *10.6 →</p> <p>12: *10.2 ↗</p> <p>13: 9.2 ↗</p> <p>14: 9.8 ↗</p> <p>15: *10.6 ↗</p> <p>16: *10.5 ↗</p> <p>17: *10.5 ↗</p> <p>18: 10.0 ↗</p> <p>19: *10.7 ↘</p> <p>20: 10.0 ↗</p>
Serie	95.0	Serie	98.0
Total	95.0	Total	193.0

<p>60 Skud</p>	<p>21: *10.3 ←</p> <p>22: *10.9 ↗</p> <p>23: 9.5 →</p> <p>24: 9.9 ←</p> <p>25: 9.7 ↘</p> <p>26: *10.6 ↗</p> <p>27: *10.7 ↗</p> <p>28: *10.8 ↗</p> <p>29: 9.2 →</p> <p>30: *10.7 ↗</p>	<p>60 Skud</p>	<p>31: 9.3 ↗</p> <p>32: *10.8 ↗</p> <p>33: 9.2 ←</p> <p>34: *10.3 ↘</p> <p>35: *10.2 ↗</p> <p>36: 9.9 ←</p> <p>37: 9.6 →</p> <p>38: *10.4 ↗</p> <p>39: *10.2 ↗</p> <p>40: 10.0 ↘</p>
Serie	96.0	Serie	96.0
Total	289.0	Total	385.0

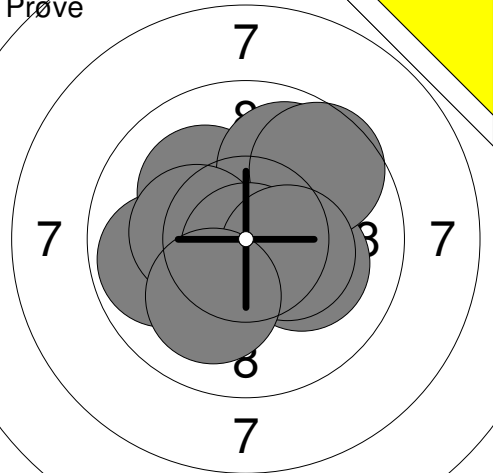
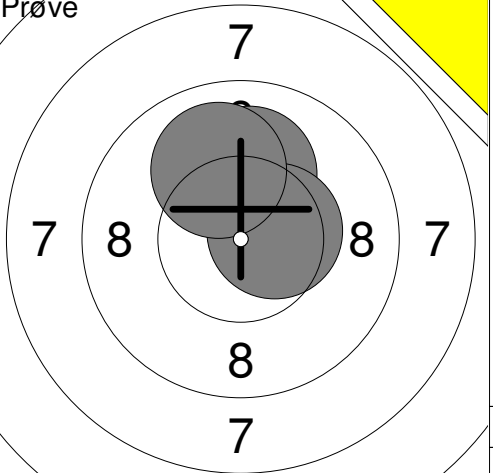
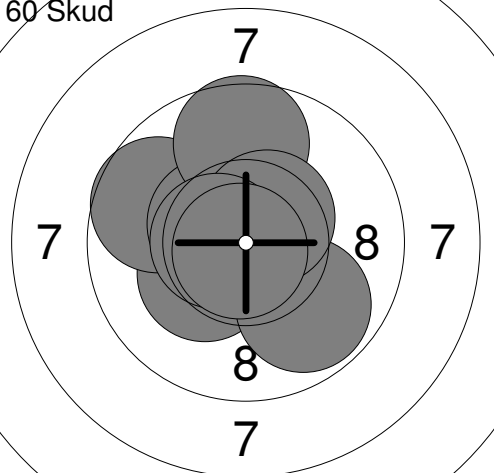
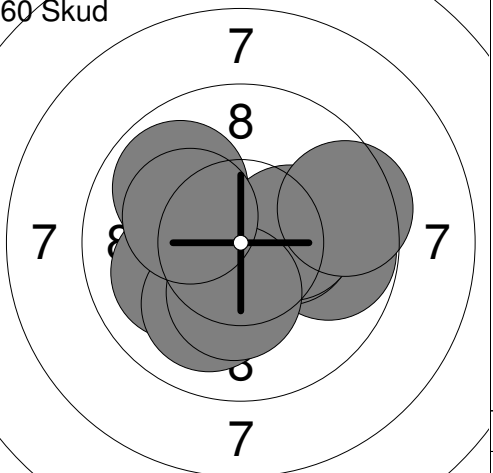
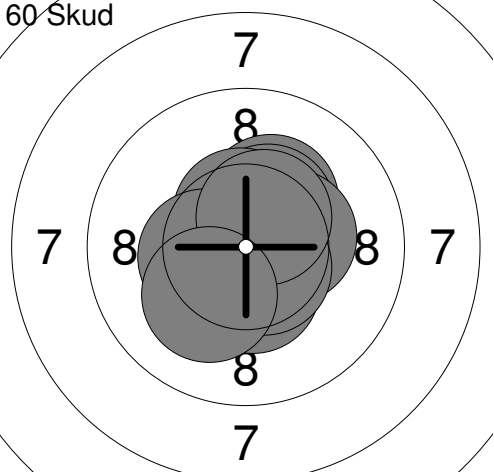
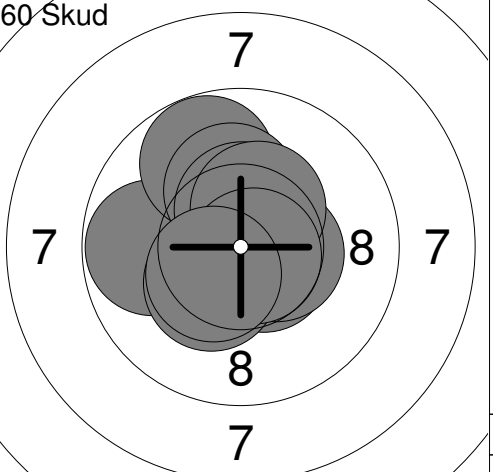
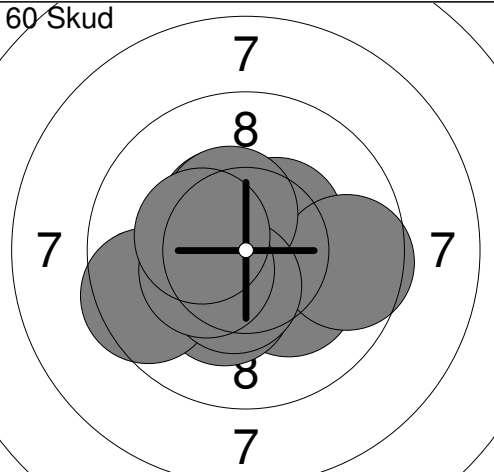
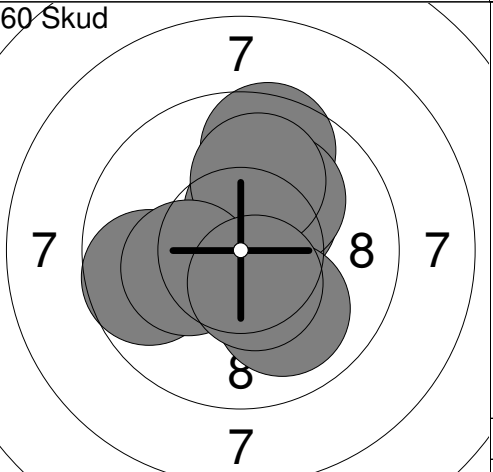

<p>60 Skud</p>	<p>41: *10.2 →</p> <p>42: 10.1 ↗</p> <p>43: 9.9 ↗</p> <p>44: 8.5 ↗</p> <p>45: 10.1 ←</p> <p>46: 8.5 →</p> <p>47: *10.2 ↗</p> <p>48: 9.8 ↗</p> <p>49: 9.3 ↘</p> <p>50: *10.7 →</p>	<p>60 Skud</p>	<p>51: *10.8 ↗</p> <p>52: *10.5 →</p> <p>53: 8.2 →</p> <p>54: 10.0 →</p> <p>55: *10.2 ↗</p> <p>56: 9.3 ↗</p> <p>57: 9.6 ←</p> <p>58: 9.8 →</p> <p>59: 9.5 ←</p> <p>60: *10.8 ←</p>
Serie	93.0	Serie	94.0
Total	478.0	Total	572.0

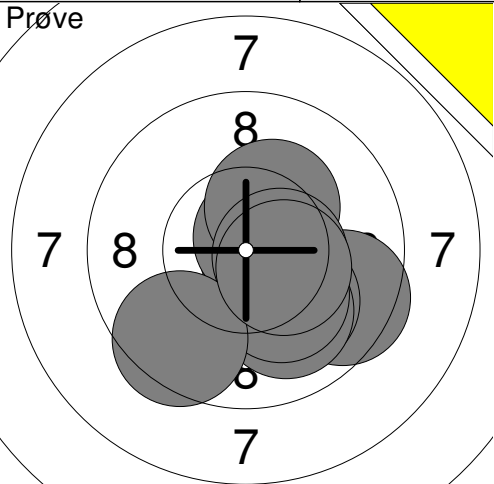
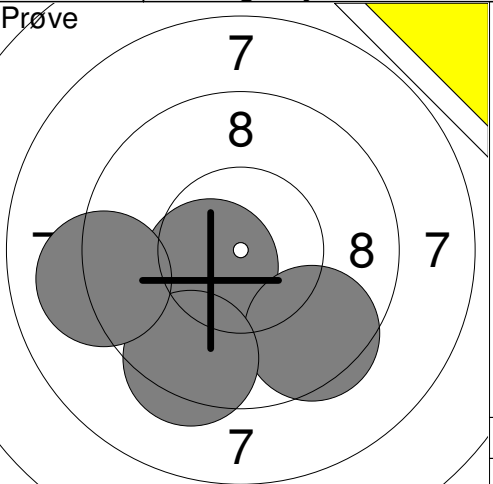
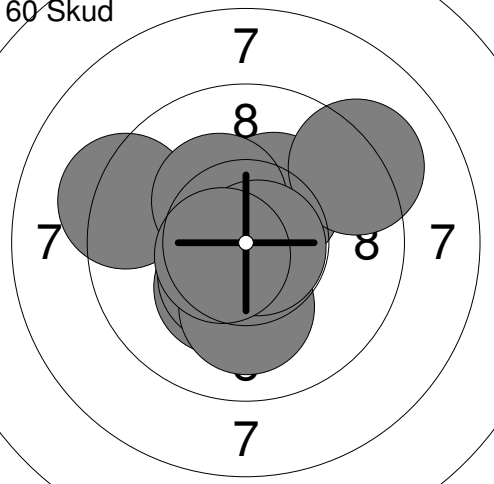
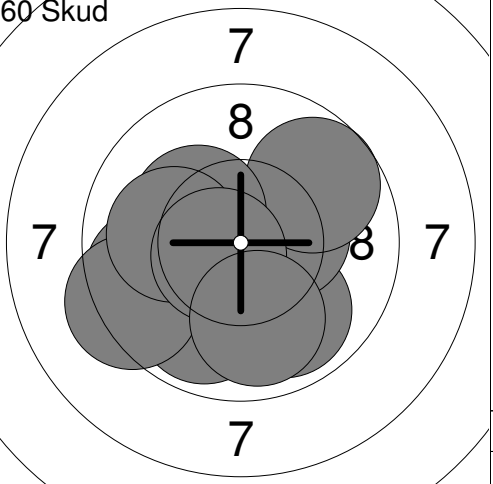
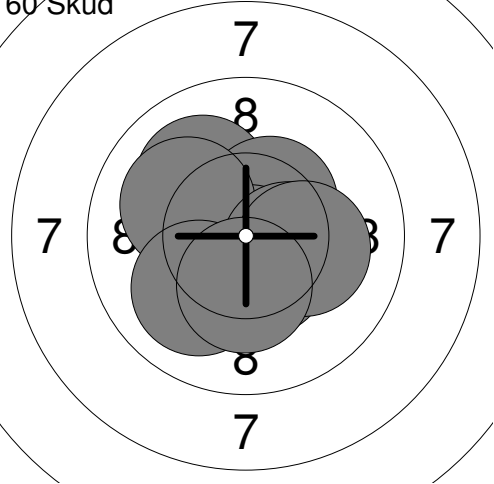
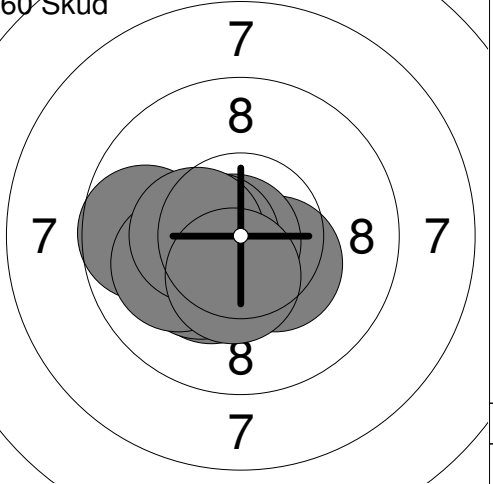
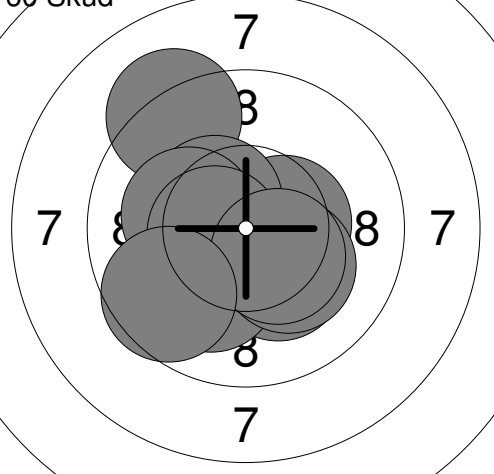
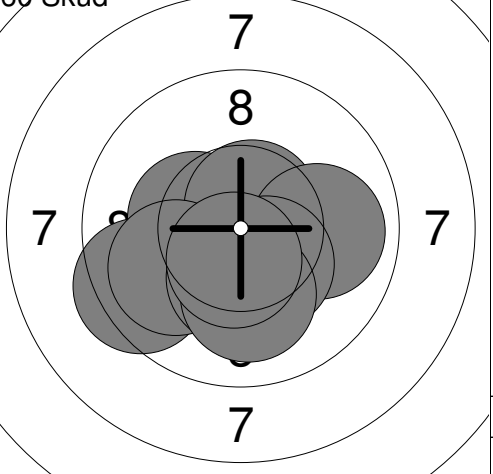
Hold	Skive	Esben Jakobsen			
1	6	Særslev Skytteforening		H	R
10m		DIF 4. runde		Aalborg Skyttekreds	
19.01.2013					
Prøve		1: 9.8 ←	Prøve		11: 10.1 ↑
		2: 10.1 ↗			12: *10.5 →
		3: *10.7 →			13: 10.0 ↑
		4: 10.1 ↘			
		5: 9.9 ↗			
		6: 9.6 ↗			
		7: *10.3 ←			
		8: *10.8 ↓			
		9: *10.4 →			
		10: 10.1 ↓			
		Serie 97.0		Serie 30.0	
		Total 0.0		Total 0.0	
60 Skud		1: *10.3 ↙	60 Skud		11: 10.1 →
		2: 9.7 ↙			12: 9.8 →
		3: *10.5 ↗			13: *10.3 →
		4: *10.8 ←		14: *10.3 →	
		5: *10.6 ↗		15: 10.0 ←	
		6: 9.6 ↑		16: 10.0 ↓	
		7: 9.8 ↓		17: *10.3 ↓	
		8: *10.5 ↗		18: 9.5 →	
		9: *10.6 ←		19: 9.9 ↗	
		10: *10.8 ↓		20: *10.2 ↙	
		Serie 97.0		Serie 97.0	
		Total 97.0		Total 194.0	
60 Skud		21: *10.3 ↗	60 Skud		31: *10.6 ↘
		22: *10.4 ↗			32: 9.8 ←
		23: *10.8 ←			33: *10.5 →
		24: *10.4 ↓		34: 9.8 ↗	
		25: *10.4 →		35: *10.2 ↑	
		26: *10.5 ↑		36: *10.5 ↑	
		27: *10.6 ↓		37: *10.4 ↑	
		28: *10.4 ←		38: *10.3 ↙	
		29: *10.5 ↗		39: *10.7 ↘	
		30: *10.2 ↓		40: *10.4 ↙	
		Serie 100.0		Serie 98.0	
		Total 294.0		Total 392.0	
60 Skud		41: *10.4 ↗	60 Skud		51: *10.9 ↑
		42: *10.2 ↘			52: 9.6 ↑
		43: *10.4 ↗			53: *10.3 ↗
		44: 9.6 →		54: *10.4 ↑	
		45: *10.3 ↓		55: 10.1 ↗	
		46: 9.5 ←		56: 10.0 ↑	
		47: *10.4 ↗		57: 9.7 ←	
		48: *10.5 ↓		58: 10.0 ↓	
		49: *10.4 ←		59: *10.2 ←	
		50: *10.3 ←		60: *10.5 ↓	
		Serie 98.0		Serie 98.0	
		Total 490.0		Total 588.0	

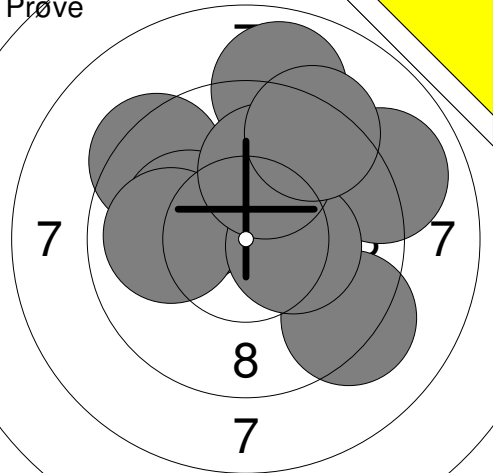
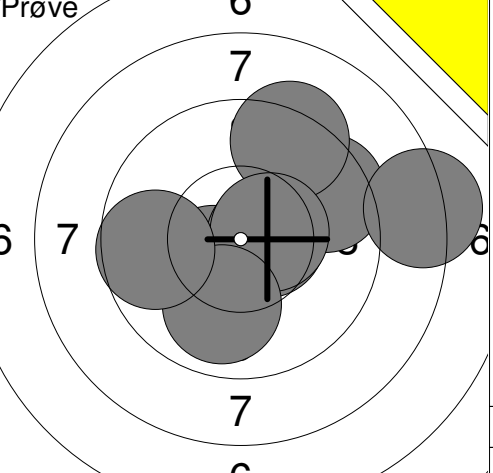
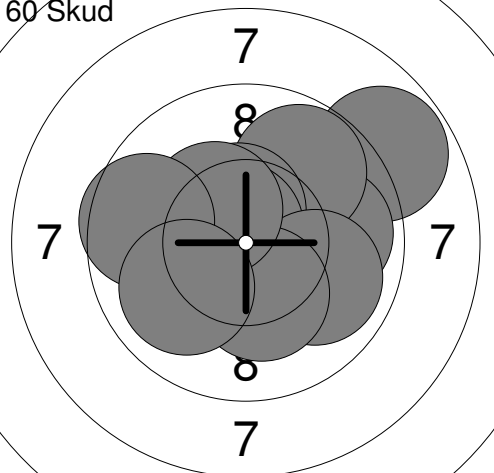
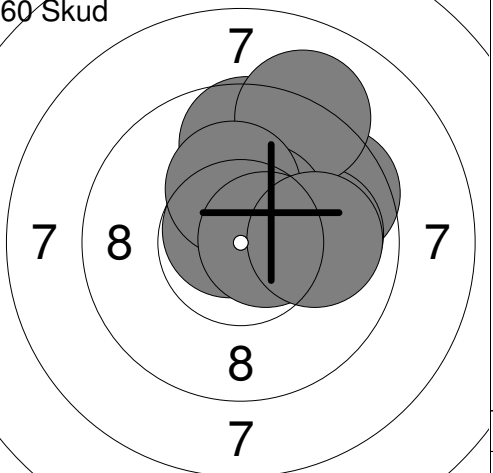
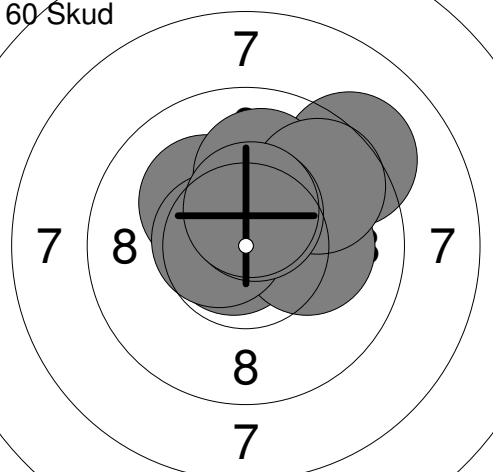
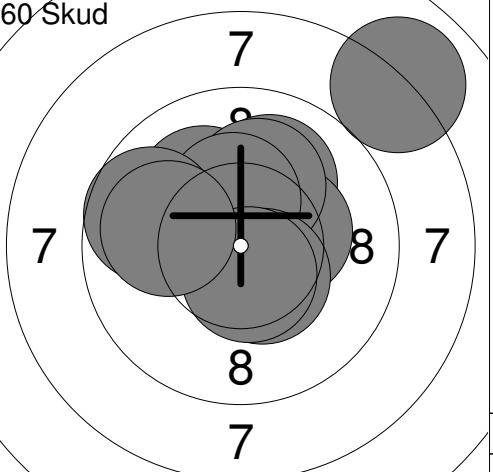
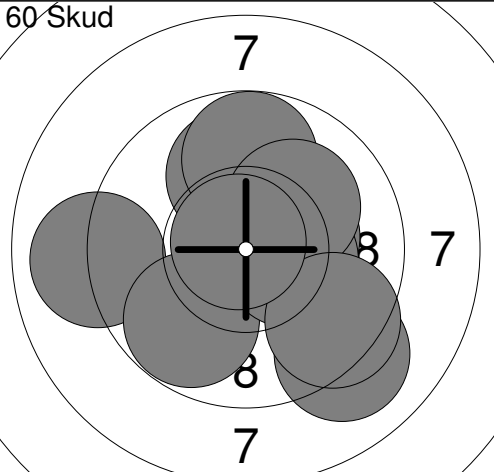
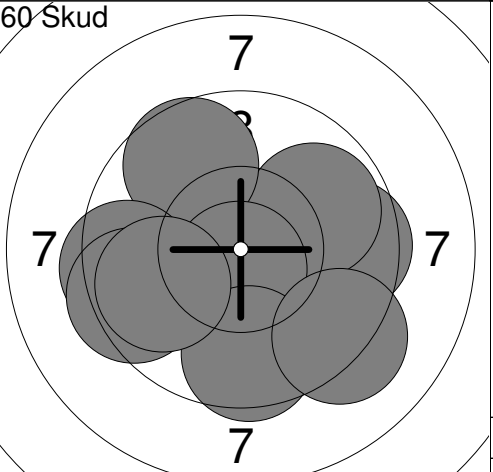
Hold	Skive	Camilla Andersen	
1	7		
10m	BPI		DJ R
19.01.2013	DIF 4. runde	Aalborg Skyttekreds	
Prøve		1: 9.5 ↘ 2: *10.6 → 3: 10.0 ↘ 4: 10.0 ↘ 5: *10.2 ↘ 6: *10.7 ↗ 7: *10.3 ↗ 8: *10.5 → 9: 9.5 ↘ 10: *10.4 ↘ Serie 98.0 Total 0.0	Prøve  11: *10.5 ← 12: 9.5 ↘ 13: 9.4 ↘ 14: 9.1 ← Serie 37.0 Total 0.0
60 Skud		1: *10.3 ↘ 2: *10.4 ↘ 3: *10.7 ← 4: 10.1 ↘ 5: 9.3 ↗ 6: *10.3 ↗ 7: *10.3 ↗ 8: 9.2 ↗ 9: *10.8 → 10: *10.6 ← Serie 98.0 Total 98.0	60 Skud  11: 9.9 ↘ 12: *10.4 → 13: 9.7 ← 14: 9.9 ↘ 15: 9.7 ↗ 16: 9.3 ← 17: *10.3 ↗ 18: 10.1 ← 19: *10.6 ← 20: 9.9 ↘ Serie 94.0 Total 192.0
60 Skud		21: 10.0 ↗ 22: *10.5 ↘ 23: *10.9 ↘ 24: *10.4 ↗ 25: *10.7 ↘ 26: 10.1 ↗ 27: 10.0 ↘ 28: *10.3 → 29: *10.2 → 30: *10.3 ↘ Serie 100.0 Total 292.0	60 Skud  31: *10.3 ↘ 32: *10.2 ↘ 33: *10.4 ↘ 34: *10.7 ← 35: 9.7 ← 36: 10.0 ← 37: *10.8 ↘ 38: *10.6 ← 39: *10.4 ← 40: *10.4 ↘ Serie 99.0 Total 391.0
60 Skud		41: *10.4 → 42: *10.2 ↘ 43: 9.2 ↗ 44: *10.4 ↗ 45: *10.2 ↗ 46: 10.1 ↘ 47: *10.2 ↘ 48: *10.5 ← 49: *10.4 ↘ 50: 9.6 ↘ Serie 98.0 Total 489.0	60 Skud  51: *10.3 ← 52: *10.6 ↗ 53: 9.4 ← 54: *10.4 ↘ 55: 9.9 → 56: 10.0 ← 57: *10.4 ↘ 58: *10.3 ↘ 59: 10.1 ↘ 60: *10.5 ↘ Serie 98.0 Total 587.0

Prøve		Prøve																																																																									
	<table border="1" style="width:100%; border-collapse: collapse;"> <tr><td>1:</td><td>9.2</td><td>↘</td></tr> <tr><td>2:</td><td>*10.5</td><td>↑</td></tr> <tr><td>3:</td><td>9.4</td><td>↗</td></tr> <tr><td>4:</td><td>8.9</td><td>↑</td></tr> <tr><td>5:</td><td>10.1</td><td>↖</td></tr> <tr><td>6:</td><td>10.0</td><td>←</td></tr> <tr><td>7:</td><td>9.0</td><td>↗</td></tr> <tr><td>8:</td><td>*10.3</td><td>→</td></tr> <tr><td>9:</td><td>10.0</td><td>↑</td></tr> <tr><td>10:</td><td>9.3</td><td>↗</td></tr> <tr><td colspan="2">Serie</td><td style="text-align: right;">94.0</td></tr> <tr><td colspan="2">Total</td><td style="text-align: right;">0.0</td></tr> </table>	1:	9.2	↘	2:	*10.5	↑	3:	9.4	↗	4:	8.9	↑	5:	10.1	↖	6:	10.0	←	7:	9.0	↗	8:	*10.3	→	9:	10.0	↑	10:	9.3	↗	Serie		94.0	Total		0.0		<table border="1" style="width:100%; border-collapse: collapse;"> <tr><td>11:</td><td>*10.4</td><td>↖</td></tr> <tr><td>12:</td><td>9.5</td><td>↗</td></tr> <tr><td>13:</td><td>*10.6</td><td>→</td></tr> <tr><td>14:</td><td>9.3</td><td>↗</td></tr> <tr><td>15:</td><td>8.2</td><td>→</td></tr> <tr><td>16:</td><td>*10.5</td><td>→</td></tr> <tr><td>17:</td><td>9.9</td><td>↓</td></tr> <tr><td>18:</td><td>9.7</td><td>←</td></tr> <tr><td colspan="2">Serie</td><td style="text-align: right;">74.0</td></tr> <tr><td colspan="2">Total</td><td style="text-align: right;">0.0</td></tr> </table>	11:	*10.4	↖	12:	9.5	↗	13:	*10.6	→	14:	9.3	↗	15:	8.2	→	16:	*10.5	→	17:	9.9	↓	18:	9.7	←	Serie		74.0	Total		0.0						
1:	9.2	↘																																																																									
2:	*10.5	↑																																																																									
3:	9.4	↗																																																																									
4:	8.9	↑																																																																									
5:	10.1	↖																																																																									
6:	10.0	←																																																																									
7:	9.0	↗																																																																									
8:	*10.3	→																																																																									
9:	10.0	↑																																																																									
10:	9.3	↗																																																																									
Serie		94.0																																																																									
Total		0.0																																																																									
11:	*10.4	↖																																																																									
12:	9.5	↗																																																																									
13:	*10.6	→																																																																									
14:	9.3	↗																																																																									
15:	8.2	→																																																																									
16:	*10.5	→																																																																									
17:	9.9	↓																																																																									
18:	9.7	←																																																																									
Serie		74.0																																																																									
Total		0.0																																																																									
60 Skud 	<table border="1" style="width:100%; border-collapse: collapse;"> <tr><td>1:</td><td>8.8</td><td>↗</td></tr> <tr><td>2:</td><td>9.9</td><td>→</td></tr> <tr><td>3:</td><td>9.8</td><td>↗</td></tr> <tr><td>4:</td><td>*10.5</td><td>↑</td></tr> <tr><td>5:</td><td>*10.7</td><td>↗</td></tr> <tr><td>6:</td><td>9.9</td><td>↘</td></tr> <tr><td>7:</td><td>*10.2</td><td>↘</td></tr> <tr><td>8:</td><td>*10.4</td><td>↗</td></tr> <tr><td>9:</td><td>9.6</td><td>←</td></tr> <tr><td>10:</td><td>10.0</td><td>↖</td></tr> <tr><td colspan="2">Serie</td><td style="text-align: right;">94.0</td></tr> <tr><td colspan="2">Total</td><td style="text-align: right;">94.0</td></tr> </table>	1:	8.8	↗	2:	9.9	→	3:	9.8	↗	4:	*10.5	↑	5:	*10.7	↗	6:	9.9	↘	7:	*10.2	↘	8:	*10.4	↗	9:	9.6	←	10:	10.0	↖	Serie		94.0	Total		94.0	60 Skud 	<table border="1" style="width:100%; border-collapse: collapse;"> <tr><td>11:</td><td>*10.5</td><td>↑</td></tr> <tr><td>12:</td><td>9.7</td><td>↑</td></tr> <tr><td>13:</td><td>9.6</td><td>↗</td></tr> <tr><td>14:</td><td>10.0</td><td>→</td></tr> <tr><td>15:</td><td>9.1</td><td>↗</td></tr> <tr><td>16:</td><td>*10.5</td><td>↗</td></tr> <tr><td>17:</td><td>*10.7</td><td>↗</td></tr> <tr><td>18:</td><td>*10.2</td><td>↑</td></tr> <tr><td>19:</td><td>*10.6</td><td>→</td></tr> <tr><td>20:</td><td>10.0</td><td>→</td></tr> <tr><td colspan="2">Serie</td><td style="text-align: right;">97.0</td></tr> <tr><td colspan="2">Total</td><td style="text-align: right;">191.0</td></tr> </table>	11:	*10.5	↑	12:	9.7	↑	13:	9.6	↗	14:	10.0	→	15:	9.1	↗	16:	*10.5	↗	17:	*10.7	↗	18:	*10.2	↑	19:	*10.6	→	20:	10.0	→	Serie		97.0	Total		191.0
1:	8.8	↗																																																																									
2:	9.9	→																																																																									
3:	9.8	↗																																																																									
4:	*10.5	↑																																																																									
5:	*10.7	↗																																																																									
6:	9.9	↘																																																																									
7:	*10.2	↘																																																																									
8:	*10.4	↗																																																																									
9:	9.6	←																																																																									
10:	10.0	↖																																																																									
Serie		94.0																																																																									
Total		94.0																																																																									
11:	*10.5	↑																																																																									
12:	9.7	↑																																																																									
13:	9.6	↗																																																																									
14:	10.0	→																																																																									
15:	9.1	↗																																																																									
16:	*10.5	↗																																																																									
17:	*10.7	↗																																																																									
18:	*10.2	↑																																																																									
19:	*10.6	→																																																																									
20:	10.0	→																																																																									
Serie		97.0																																																																									
Total		191.0																																																																									
60 Skud 	<table border="1" style="width:100%; border-collapse: collapse;"> <tr><td>21:</td><td>9.2</td><td>↗</td></tr> <tr><td>22:</td><td>*10.8</td><td>←</td></tr> <tr><td>23:</td><td>*10.2</td><td>↗</td></tr> <tr><td>24:</td><td>*10.3</td><td>↗</td></tr> <tr><td>25:</td><td>10.1</td><td>→</td></tr> <tr><td>26:</td><td>10.0</td><td>↑</td></tr> <tr><td>27:</td><td>9.7</td><td>↗</td></tr> <tr><td>28:</td><td>*10.6</td><td>←</td></tr> <tr><td>29:</td><td>*10.5</td><td>↑</td></tr> <tr><td>30:</td><td>*10.5</td><td>↑</td></tr> <tr><td colspan="2">Serie</td><td style="text-align: right;">98.0</td></tr> <tr><td colspan="2">Total</td><td style="text-align: right;">289.0</td></tr> </table>	21:	9.2	↗	22:	*10.8	←	23:	*10.2	↗	24:	*10.3	↗	25:	10.1	→	26:	10.0	↑	27:	9.7	↗	28:	*10.6	←	29:	*10.5	↑	30:	*10.5	↑	Serie		98.0	Total		289.0	60 Skud 	<table border="1" style="width:100%; border-collapse: collapse;"> <tr><td>31:</td><td>8.0</td><td>↗</td></tr> <tr><td>32:</td><td>10.0</td><td>↗</td></tr> <tr><td>33:</td><td>10.1</td><td>↗</td></tr> <tr><td>34:</td><td>*10.3</td><td>→</td></tr> <tr><td>35:</td><td>10.1</td><td>↑</td></tr> <tr><td>36:</td><td>*10.3</td><td>↑</td></tr> <tr><td>37:</td><td>*10.5</td><td>↘</td></tr> <tr><td>38:</td><td>9.7</td><td>←</td></tr> <tr><td>39:</td><td>*10.6</td><td>↓</td></tr> <tr><td>40:</td><td>10.0</td><td>←</td></tr> <tr><td colspan="2">Serie</td><td style="text-align: right;">97.0</td></tr> <tr><td colspan="2">Total</td><td style="text-align: right;">386.0</td></tr> </table>	31:	8.0	↗	32:	10.0	↗	33:	10.1	↗	34:	*10.3	→	35:	10.1	↑	36:	*10.3	↑	37:	*10.5	↘	38:	9.7	←	39:	*10.6	↓	40:	10.0	←	Serie		97.0	Total		386.0
21:	9.2	↗																																																																									
22:	*10.8	←																																																																									
23:	*10.2	↗																																																																									
24:	*10.3	↗																																																																									
25:	10.1	→																																																																									
26:	10.0	↑																																																																									
27:	9.7	↗																																																																									
28:	*10.6	←																																																																									
29:	*10.5	↑																																																																									
30:	*10.5	↑																																																																									
Serie		98.0																																																																									
Total		289.0																																																																									
31:	8.0	↗																																																																									
32:	10.0	↗																																																																									
33:	10.1	↗																																																																									
34:	*10.3	→																																																																									
35:	10.1	↑																																																																									
36:	*10.3	↑																																																																									
37:	*10.5	↘																																																																									
38:	9.7	←																																																																									
39:	*10.6	↓																																																																									
40:	10.0	←																																																																									
Serie		97.0																																																																									
Total		386.0																																																																									
60 Skud 	<table border="1" style="width:100%; border-collapse: collapse;"> <tr><td>41:</td><td>9.0</td><td>←</td></tr> <tr><td>42:</td><td>10.0</td><td>↑</td></tr> <tr><td>43:</td><td>9.8</td><td>↘</td></tr> <tr><td>44:</td><td>*10.3</td><td>→</td></tr> <tr><td>45:</td><td>*10.3</td><td>→</td></tr> <tr><td>46:</td><td>9.1</td><td>↘</td></tr> <tr><td>47:</td><td>9.8</td><td>↑</td></tr> <tr><td>48:</td><td>10.1</td><td>↗</td></tr> <tr><td>49:</td><td>9.5</td><td>↘</td></tr> <tr><td>50:</td><td>*10.8</td><td>↗</td></tr> <tr><td colspan="2">Serie</td><td style="text-align: right;">95.0</td></tr> <tr><td colspan="2">Total</td><td style="text-align: right;">481.0</td></tr> </table>	41:	9.0	←	42:	10.0	↑	43:	9.8	↘	44:	*10.3	→	45:	*10.3	→	46:	9.1	↘	47:	9.8	↑	48:	10.1	↗	49:	9.5	↘	50:	*10.8	↗	Serie		95.0	Total		481.0	60 Skud 	<table border="1" style="width:100%; border-collapse: collapse;"> <tr><td>51:</td><td>9.6</td><td>→</td></tr> <tr><td>52:</td><td>*10.3</td><td>↘</td></tr> <tr><td>53:</td><td>9.9</td><td>↗</td></tr> <tr><td>54:</td><td>9.7</td><td>↗</td></tr> <tr><td>55:</td><td>9.4</td><td>←</td></tr> <tr><td>56:</td><td>*10.7</td><td>↓</td></tr> <tr><td>57:</td><td>9.6</td><td>↓</td></tr> <tr><td>58:</td><td>9.4</td><td>←</td></tr> <tr><td>59:</td><td>9.8</td><td>←</td></tr> <tr><td>60:</td><td>9.2</td><td>↘</td></tr> <tr><td colspan="2">Serie</td><td style="text-align: right;">92.0</td></tr> <tr><td colspan="2">Total</td><td style="text-align: right;">573.0</td></tr> </table>	51:	9.6	→	52:	*10.3	↘	53:	9.9	↗	54:	9.7	↗	55:	9.4	←	56:	*10.7	↓	57:	9.6	↓	58:	9.4	←	59:	9.8	←	60:	9.2	↘	Serie		92.0	Total		573.0
41:	9.0	←																																																																									
42:	10.0	↑																																																																									
43:	9.8	↘																																																																									
44:	*10.3	→																																																																									
45:	*10.3	→																																																																									
46:	9.1	↘																																																																									
47:	9.8	↑																																																																									
48:	10.1	↗																																																																									
49:	9.5	↘																																																																									
50:	*10.8	↗																																																																									
Serie		95.0																																																																									
Total		481.0																																																																									
51:	9.6	→																																																																									
52:	*10.3	↘																																																																									
53:	9.9	↗																																																																									
54:	9.7	↗																																																																									
55:	9.4	←																																																																									
56:	*10.7	↓																																																																									
57:	9.6	↓																																																																									
58:	9.4	←																																																																									
59:	9.8	←																																																																									
60:	9.2	↘																																																																									
Serie		92.0																																																																									
Total		573.0																																																																									

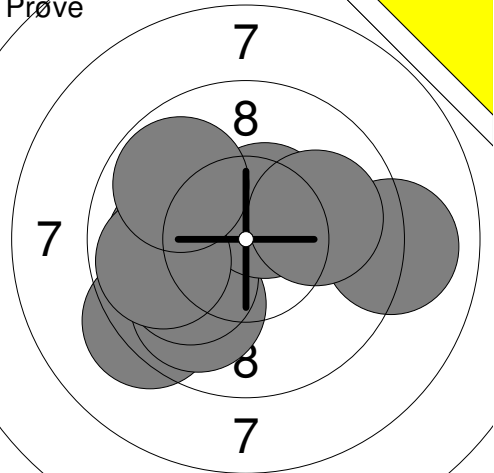
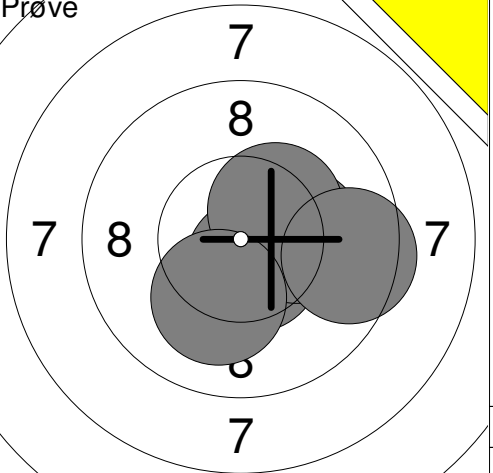
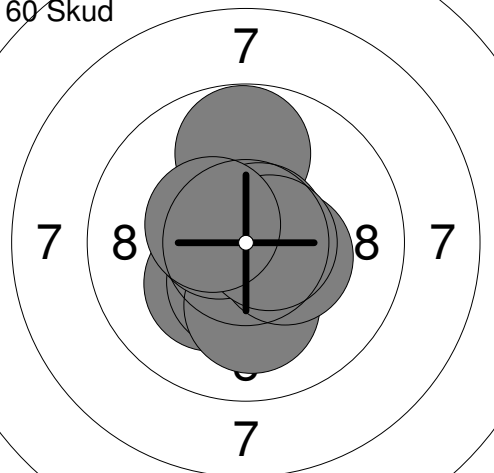
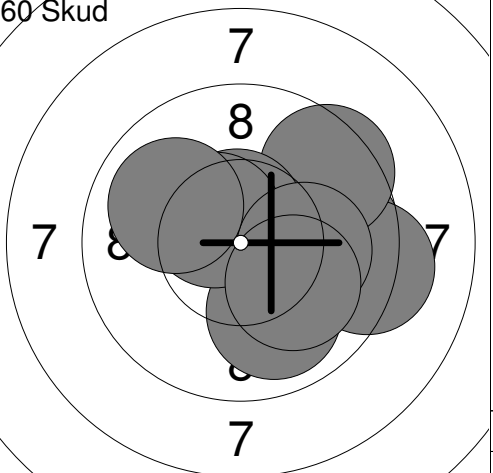
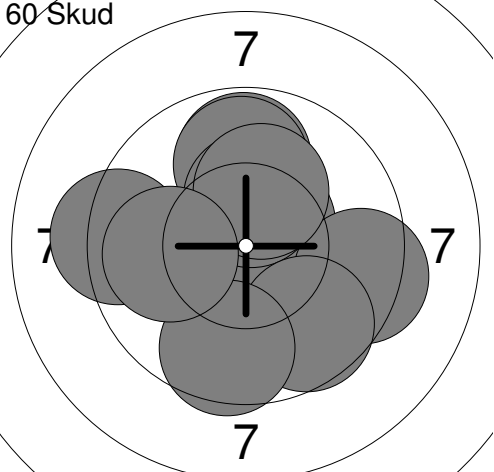
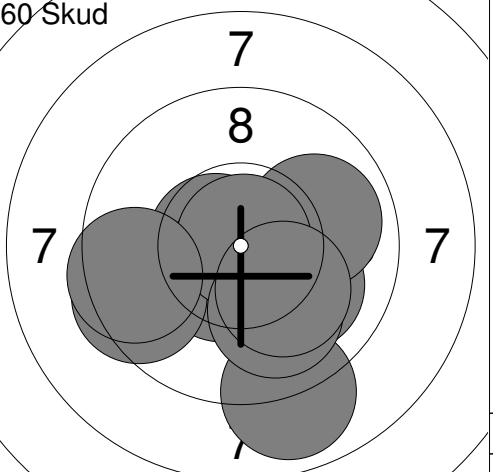
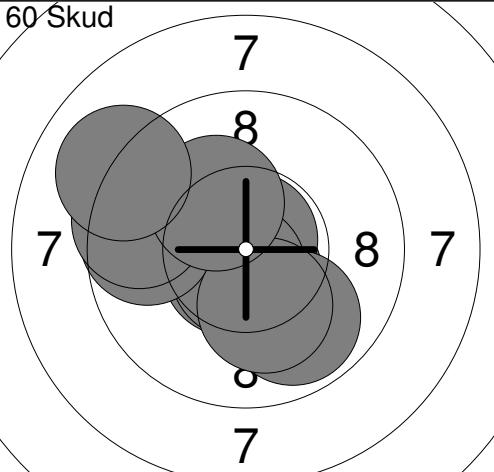
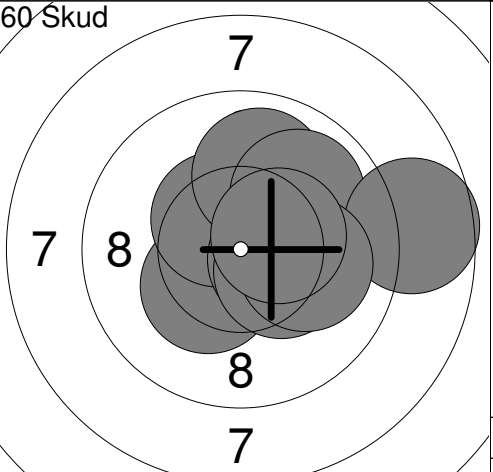

Prøve	Prøve																											
		<table style="width:100%; border-collapse: collapse;"> <tr><td>1: 10.0</td><td>←</td></tr> <tr><td>2: 10.1</td><td>←</td></tr> <tr><td>3: 9.3</td><td>↙</td></tr> <tr><td>4: 9.9</td><td>↘</td></tr> <tr><td>5: 10.1</td><td>←</td></tr> <tr><td>6: *10.5</td><td>↗</td></tr> <tr><td>7: 9.0</td><td>→</td></tr> <tr><td>8: 10.0</td><td>→</td></tr> <tr><td>9: 9.8</td><td>←</td></tr> <tr><td>10: 9.8</td><td>↗</td></tr> <tr><td colspan="2"><hr/></td></tr> <tr><td>Serie</td><td style="text-align:right;">95.0</td></tr> <tr><td>Total</td><td style="text-align:right;">0.0</td></tr> </table>	1: 10.0	←	2: 10.1	←	3: 9.3	↙	4: 9.9	↘	5: 10.1	←	6: *10.5	↗	7: 9.0	→	8: 10.0	→	9: 9.8	←	10: 9.8	↗	<hr/>		Serie	95.0	Total	0.0
1: 10.0	←																											
2: 10.1	←																											
3: 9.3	↙																											
4: 9.9	↘																											
5: 10.1	←																											
6: *10.5	↗																											
7: 9.0	→																											
8: 10.0	→																											
9: 9.8	←																											
10: 9.8	↗																											
<hr/>																												
Serie	95.0																											
Total	0.0																											
<b>60 Skud</b> 	<b>60 Skud</b> 	<table style="width:100%; border-collapse: collapse;"> <tr><td>11: *10.6</td><td>↘</td></tr> <tr><td>12: *10.2</td><td>→</td></tr> <tr><td>13: *10.4</td><td>↗</td></tr> <tr><td>14: 9.5</td><td>→</td></tr> <tr><td>15: 10.1</td><td>↘</td></tr> <tr><td colspan="2"><hr/></td></tr> <tr><td>Serie</td><td style="text-align:right;">49.0</td></tr> <tr><td>Total</td><td style="text-align:right;">0.0</td></tr> </table>	11: *10.6	↘	12: *10.2	→	13: *10.4	↗	14: 9.5	→	15: 10.1	↘	<hr/>		Serie	49.0	Total	0.0										
11: *10.6	↘																											
12: *10.2	→																											
13: *10.4	↗																											
14: 9.5	→																											
15: 10.1	↘																											
<hr/>																												
Serie	49.0																											
Total	0.0																											
<b>60 Skud</b> 	<b>60 Skud</b> 	<table style="width:100%; border-collapse: collapse;"> <tr><td>1: *10.2</td><td>↙</td></tr> <tr><td>2: *10.7</td><td>↑</td></tr> <tr><td>3: 9.8</td><td>↑</td></tr> <tr><td>4: *10.4</td><td>↘</td></tr> <tr><td>5: 10.1</td><td>↘</td></tr> <tr><td>6: *10.7</td><td>↗</td></tr> <tr><td>7: *10.6</td><td>↖</td></tr> <tr><td>8: *10.4</td><td>→</td></tr> <tr><td>9: *10.6</td><td>→</td></tr> <tr><td>10: *10.5</td><td>↗</td></tr> <tr><td colspan="2"><hr/></td></tr> <tr><td>Serie</td><td style="text-align:right;">99.0</td></tr> <tr><td>Total</td><td style="text-align:right;">99.0</td></tr> </table>	1: *10.2	↙	2: *10.7	↑	3: 9.8	↑	4: *10.4	↘	5: 10.1	↘	6: *10.7	↗	7: *10.6	↖	8: *10.4	→	9: *10.6	→	10: *10.5	↗	<hr/>		Serie	99.0	Total	99.0
1: *10.2	↙																											
2: *10.7	↑																											
3: 9.8	↑																											
4: *10.4	↘																											
5: 10.1	↘																											
6: *10.7	↗																											
7: *10.6	↖																											
8: *10.4	→																											
9: *10.6	→																											
10: *10.5	↗																											
<hr/>																												
Serie	99.0																											
Total	99.0																											
<b>60 Skud</b> 	<b>60 Skud</b> 	<table style="width:100%; border-collapse: collapse;"> <tr><td>11: 9.7</td><td>→</td></tr> <tr><td>12: 9.9</td><td>→</td></tr> <tr><td>13: 9.3</td><td>→</td></tr> <tr><td>14: 9.9</td><td>↘</td></tr> <tr><td>15: 9.5</td><td>↗</td></tr> <tr><td>16: *10.6</td><td>↑</td></tr> <tr><td>17: *10.5</td><td>↗</td></tr> <tr><td>18: 10.1</td><td>→</td></tr> <tr><td>19: 10.0</td><td>↖</td></tr> <tr><td>20: 10.1</td><td>↘</td></tr> <tr><td colspan="2"><hr/></td></tr> <tr><td>Serie</td><td style="text-align:right;">95.0</td></tr> <tr><td>Total</td><td style="text-align:right;">194.0</td></tr> </table>	11: 9.7	→	12: 9.9	→	13: 9.3	→	14: 9.9	↘	15: 9.5	↗	16: *10.6	↑	17: *10.5	↗	18: 10.1	→	19: 10.0	↖	20: 10.1	↘	<hr/>		Serie	95.0	Total	194.0
11: 9.7	→																											
12: 9.9	→																											
13: 9.3	→																											
14: 9.9	↘																											
15: 9.5	↗																											
16: *10.6	↑																											
17: *10.5	↗																											
18: 10.1	→																											
19: 10.0	↖																											
20: 10.1	↘																											
<hr/>																												
Serie	95.0																											
Total	194.0																											
<b>60 Skud</b> 	<b>60 Skud</b> 	<table style="width:100%; border-collapse: collapse;"> <tr><td>21: *10.5</td><td>↗</td></tr> <tr><td>22: 9.8</td><td>↑</td></tr> <tr><td>23: 9.9</td><td>↑</td></tr> <tr><td>24: *10.3</td><td>↑</td></tr> <tr><td>25: 9.4</td><td>→</td></tr> <tr><td>26: 9.6</td><td>↘</td></tr> <tr><td>27: *10.2</td><td>↑</td></tr> <tr><td>28: 9.6</td><td>↘</td></tr> <tr><td>29: 9.3</td><td>←</td></tr> <tr><td>30: 9.9</td><td>←</td></tr> <tr><td colspan="2"><hr/></td></tr> <tr><td>Serie</td><td style="text-align:right;">93.0</td></tr> <tr><td>Total</td><td style="text-align:right;">287.0</td></tr> </table>	21: *10.5	↗	22: 9.8	↑	23: 9.9	↑	24: *10.3	↑	25: 9.4	→	26: 9.6	↘	27: *10.2	↑	28: 9.6	↘	29: 9.3	←	30: 9.9	←	<hr/>		Serie	93.0	Total	287.0
21: *10.5	↗																											
22: 9.8	↑																											
23: 9.9	↑																											
24: *10.3	↑																											
25: 9.4	→																											
26: 9.6	↘																											
27: *10.2	↑																											
28: 9.6	↘																											
29: 9.3	←																											
30: 9.9	←																											
<hr/>																												
Serie	93.0																											
Total	287.0																											
<b>60 Skud</b> 	<b>60 Skud</b> 	<table style="width:100%; border-collapse: collapse;"> <tr><td>31: *10.6</td><td>←</td></tr> <tr><td>32: 10.1</td><td>↘</td></tr> <tr><td>33: 9.9</td><td>→</td></tr> <tr><td>34: *10.5</td><td>↘</td></tr> <tr><td>35: 9.5</td><td>←</td></tr> <tr><td>36: *10.9</td><td>↗</td></tr> <tr><td>37: 8.9</td><td>↘</td></tr> <tr><td>38: 10.0</td><td>↘</td></tr> <tr><td>39: 9.5</td><td>←</td></tr> <tr><td>40: 10.1</td><td>↘</td></tr> <tr><td colspan="2"><hr/></td></tr> <tr><td>Serie</td><td style="text-align:right;">95.0</td></tr> <tr><td>Total</td><td style="text-align:right;">382.0</td></tr> </table>	31: *10.6	←	32: 10.1	↘	33: 9.9	→	34: *10.5	↘	35: 9.5	←	36: *10.9	↗	37: 8.9	↘	38: 10.0	↘	39: 9.5	←	40: 10.1	↘	<hr/>		Serie	95.0	Total	382.0
31: *10.6	←																											
32: 10.1	↘																											
33: 9.9	→																											
34: *10.5	↘																											
35: 9.5	←																											
36: *10.9	↗																											
37: 8.9	↘																											
38: 10.0	↘																											
39: 9.5	←																											
40: 10.1	↘																											
<hr/>																												
Serie	95.0																											
Total	382.0																											
<b>60 Skud</b> 	<b>60 Skud</b> 	<table style="width:100%; border-collapse: collapse;"> <tr><td>41: *10.6</td><td>↘</td></tr> <tr><td>42: *10.8</td><td>↗</td></tr> <tr><td>43: 9.9</td><td>↘</td></tr> <tr><td>44: *10.6</td><td>↘</td></tr> <tr><td>45: *10.7</td><td>↘</td></tr> <tr><td>46: 9.6</td><td>←</td></tr> <tr><td>47: *10.2</td><td>↘</td></tr> <tr><td>48: 9.5</td><td>←</td></tr> <tr><td>49: *10.2</td><td>↗</td></tr> <tr><td>50: 9.0</td><td>↗</td></tr> <tr><td colspan="2"><hr/></td></tr> <tr><td>Serie</td><td style="text-align:right;">96.0</td></tr> <tr><td>Total</td><td style="text-align:right;">478.0</td></tr> </table>	41: *10.6	↘	42: *10.8	↗	43: 9.9	↘	44: *10.6	↘	45: *10.7	↘	46: 9.6	←	47: *10.2	↘	48: 9.5	←	49: *10.2	↗	50: 9.0	↗	<hr/>		Serie	96.0	Total	478.0
41: *10.6	↘																											
42: *10.8	↗																											
43: 9.9	↘																											
44: *10.6	↘																											
45: *10.7	↘																											
46: 9.6	←																											
47: *10.2	↘																											
48: 9.5	←																											
49: *10.2	↗																											
50: 9.0	↗																											
<hr/>																												
Serie	96.0																											
Total	478.0																											
<b>60 Skud</b> 	<b>60 Skud</b> 	<table style="width:100%; border-collapse: collapse;"> <tr><td>51: *10.5</td><td>→</td></tr> <tr><td>52: *10.3</td><td>↘</td></tr> <tr><td>53: *10.5</td><td>↗</td></tr> <tr><td>54: 9.9</td><td>↑</td></tr> <tr><td>55: *10.5</td><td>→</td></tr> <tr><td>56: *10.3</td><td>↘</td></tr> <tr><td>57: 9.9</td><td>↗</td></tr> <tr><td>58: 8.7</td><td>→</td></tr> <tr><td>59: 10.1</td><td>→</td></tr> <tr><td>60: *10.4</td><td>→</td></tr> <tr><td colspan="2"><hr/></td></tr> <tr><td>Serie</td><td style="text-align:right;">96.0</td></tr> <tr><td>Total</td><td style="text-align:right;">574.0</td></tr> </table>	51: *10.5	→	52: *10.3	↘	53: *10.5	↗	54: 9.9	↑	55: *10.5	→	56: *10.3	↘	57: 9.9	↗	58: 8.7	→	59: 10.1	→	60: *10.4	→	<hr/>		Serie	96.0	Total	574.0
51: *10.5	→																											
52: *10.3	↘																											
53: *10.5	↗																											
54: 9.9	↑																											
55: *10.5	→																											
56: *10.3	↘																											
57: 9.9	↗																											
58: 8.7	→																											
59: 10.1	→																											
60: *10.4	→																											
<hr/>																												
Serie	96.0																											
Total	574.0																											

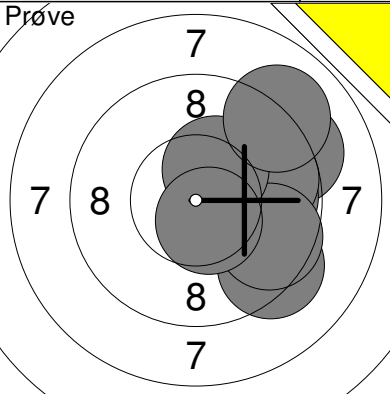
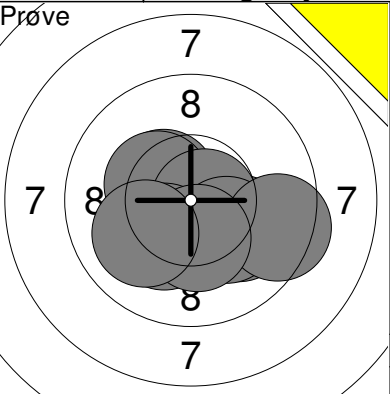
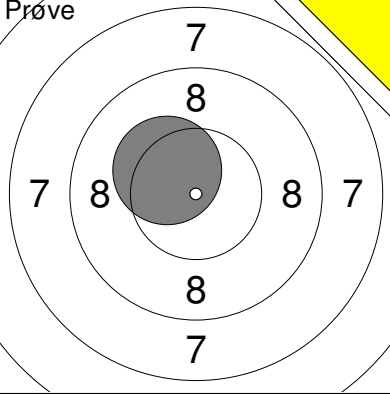
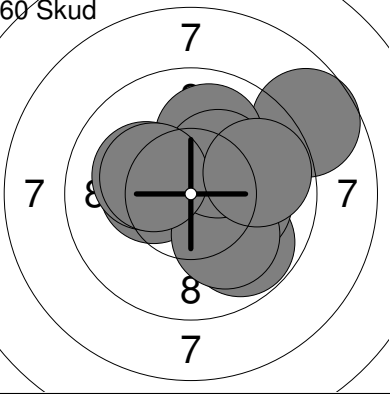
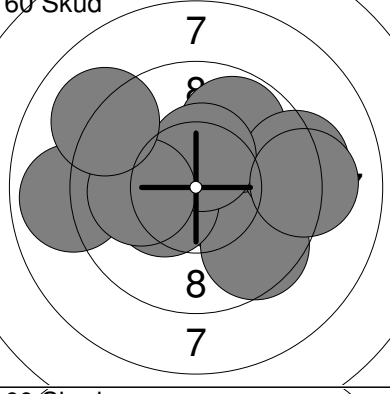
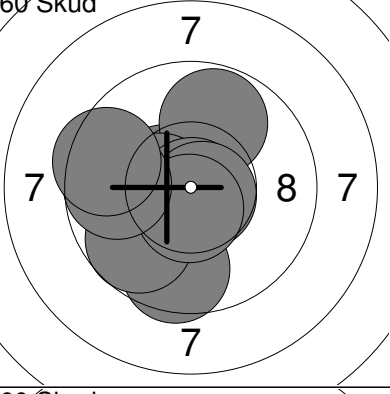
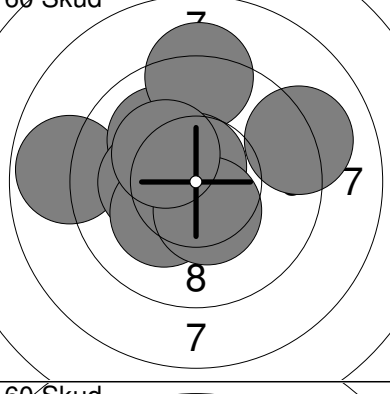
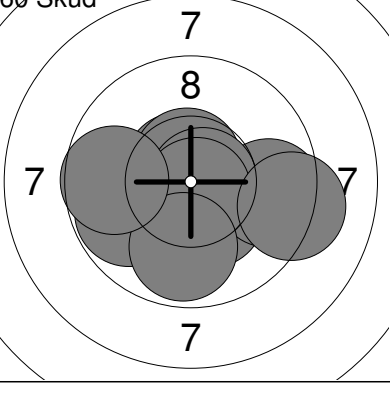
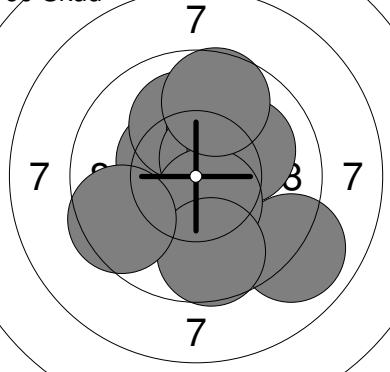
Hold	Skive	Michael H. Nielsen					
1	10	DSB/ASF 2		H	R		
19.01.2013		DIF 4. runde		Aalborg Skyttekreds			
Prøve		2: 9.2 →	Prøve		11: *10.4 ↗		
		3: *10.2 →			12: 10.0 ↓		
		4: 9.8 →			13: *10.5 ↓		
		5: 9.7 →			14: *10.3 ↗		
		6: 9.3 ↓			15: *10.7 →		
		7: 9.6 ↓			16: *10.2 ↓		
		8: *10.3 ↗			17: 9.4 →		
		9: *10.5 ↓			18: *10.2 ↓		
		10: 9.0 ↗			19: *10.3 ↓		
		Serie 84.0			Serie 99.0		
		Total 0.0			Total 0.0		
Prøve		21: *10.3 ↖	60 Skud		1: *10.3 ←		
							2: 9.8 ↓
							3: 8.7 ↗
		Serie 10.0			Serie 96.0		
		Total 0.0			Total 96.0		
60 Skud		11: 9.8 ↗	60 Skud		21: *10.5 ↖		
		12: 8.9 ←			22: 9.8 ↗		
		13: *10.5 →			23: *10.4 ←		
		14: 9.6 ↓			24: *10.9 ↓		
		15: 9.3 →			25: 9.6 ↓		
		16: *10.4 ←			26: *10.7 ↓		
		17: *10.4 ↑			27: 9.7 ↖		
		18: 10.0 ←			28: *10.6 ↓		
		19: 9.1 ↗			29: 9.7 ←		
		20: 9.1 →			30: 9.5 ↖		
		Serie 93.0			Serie 95.0		
		Total 189.0			Total 284.0		
60 Skud		31: *10.5 ←	60 Skud		41: *10.3 ↓		
		32: 8.8 ←			42: *10.6 ↗		
		33: 10.1 ↗			43: 9.6 →		
		34: 9.2 ↑			44: *10.6 ↑		
		35: *10.2 ←			45: *10.8 →		
		36: *10.7 ↑			46: 9.8 ↖		
		37: 9.1 →			47: *10.8 ↓		
		38: *10.2 ↖			48: 9.2 →		
		39: *10.4 ↓			49: 9.9 ↓		
		40: *10.3 ↗			50: 9.7 ←		
		Serie 96.0			Serie 95.0		
		Total 380.0			Total 475.0		
60 Skud		51: 9.0 ↓					
		52: *10.4 ↗					
		53: 10.1 ↗					
		54: 10.1 ↗					
		55: *10.5 ↗					
		56: 10.1 →					
		57: *10.5 ↓					
		58: 9.7 ↑					
		59: 9.7 ↓					
		60: 9.5 ↖					
		Serie 96.0					
		Total 571.0					

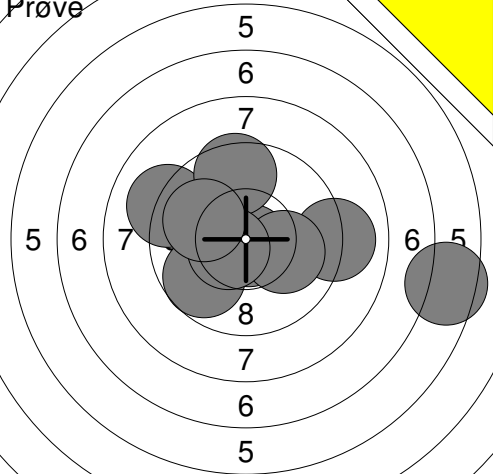
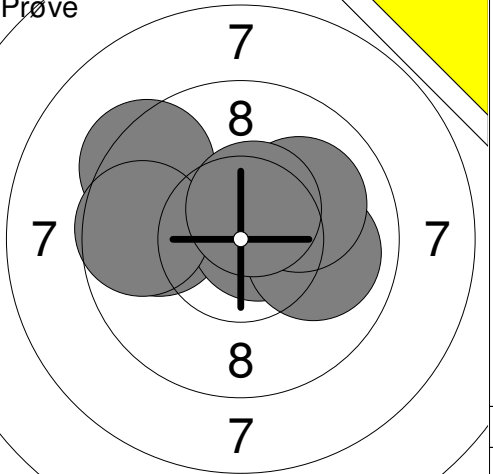
<b>Prøve</b> 	2: 6.5 → 3: 9.0 → 4: *10.8 ↓ 5: 9.7 ↙ 6: 10.1 → 7: 9.1 ↗ 8: 9.5 ↑ 9: *10.5 ← 10: 10.0 ↖	<b>Prøve</b> 	11: 9.9 ← 12: *10.2 → 13: *10.7 → 14: 9.4 ↖ 15: 9.6 ← 16: 10.0 → 17: 10.1 → 18: *10.5 ↑
Serie	82.0	Serie	77.0
Total	0.0	Total	0.0

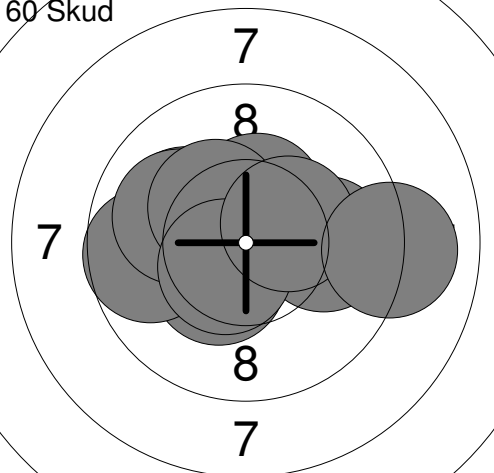
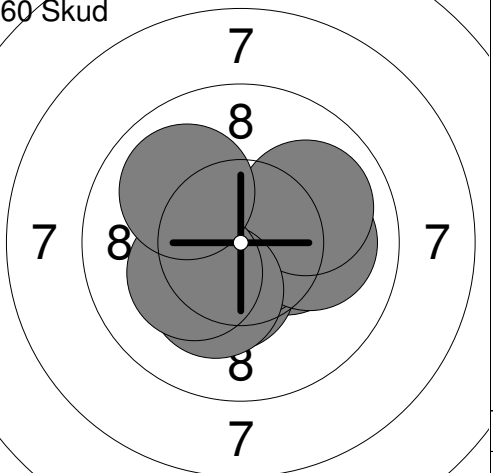
<b>60 Skud</b> 	1: *10.4 ↓ 2: 9.9 → 3: *10.4 ↑ 4: 10.1 ↖ 5: 9.7 ← 6: 10.0 ↖ 7: *10.3 ↗ 8: *10.5 ↓ 9: *10.3 → 10: 9.1 →	<b>60 Skud</b> 	11: *10.4 → 12: *10.4 ↓ 13: *10.3 ← 14: *10.7 ← 15: *10.8 ↘ 16: 10.0 → 17: 10.0 → 18: *10.2 ↓ 19: *10.2 ← 20: 10.0 ↖
Serie	97.0	Serie	100.0
Total	97.0	Total	197.0

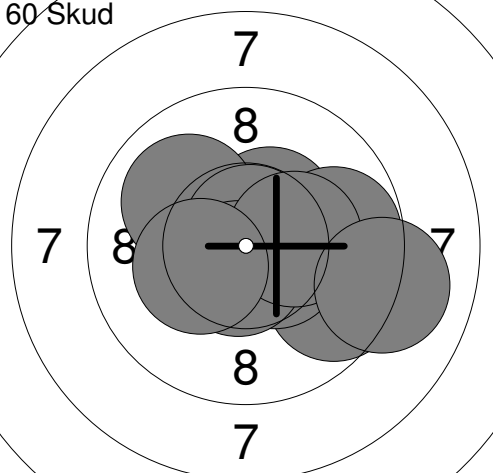
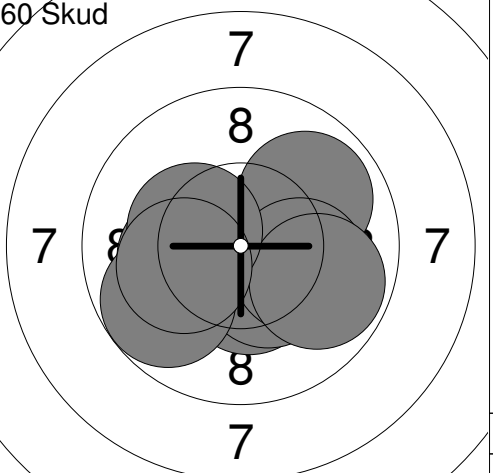
<b>60 Skud</b> 	21: *10.4 ↗ 22: 9.8 → 23: 10.0 ↗ 24: 9.6 ↘ 25: *10.8 ↑ 26: *10.5 ↘ 27: *10.6 ↓ 28: *10.3 → 29: 9.1 → 30: *10.3 ←	<b>60 Skud</b> 	31: *10.5 ← 32: *10.4 ↓ 33: *10.4 ↓ 34: 9.9 ↗ 35: *10.2 ← 36: 9.8 ↙ 37: 10.1 → 38: 9.8 ↘ 39: *10.3 ← 40: *10.2 ←
Serie	97.0	Serie	97.0
Total	294.0	Total	391.0

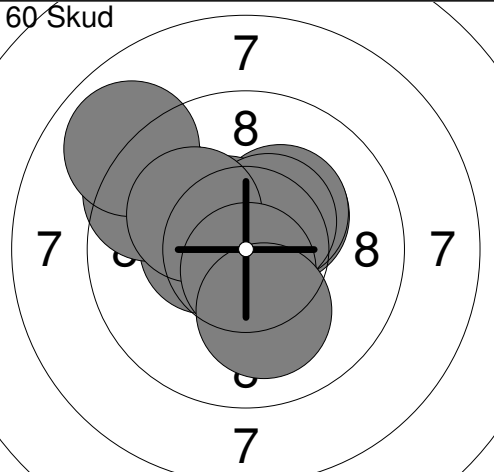
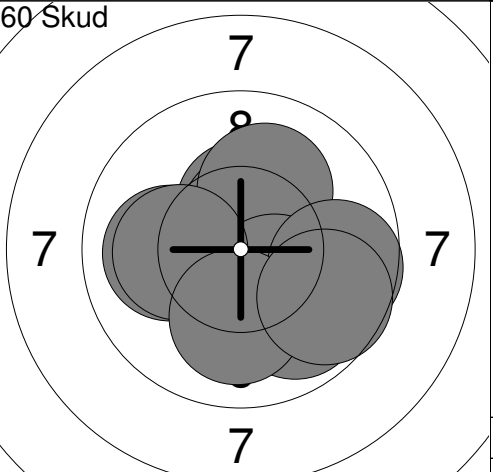
<b>60 Skud</b> 	41: *10.3 ↗ 42: *10.4 ← 43: 9.5 ↖ 44: *10.3 ↗ 45: 8.9 ↗ 46: *10.5 ↗ 47: *10.5 ↗ 48: 10.1 ↗ 49: *10.7 ↓ 50: 10.1 ↓	<b>60 Skud</b> 	51: *10.4 ↑ 52: *10.5 ↑ 53: 10.1 ↗ 54: *10.3 ↓ 55: 10.0 ← 56: 9.9 ↘ 57: 9.7 → 58: 10.1 ← 59: 10.1 ↓ 60: 9.7 ↘
Serie	97.0	Serie	97.0
Total	488.0	Total	585.0

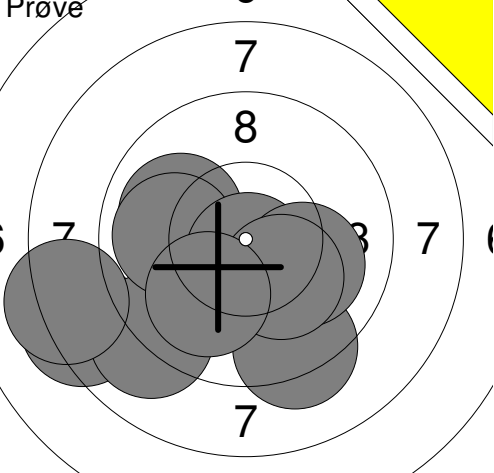
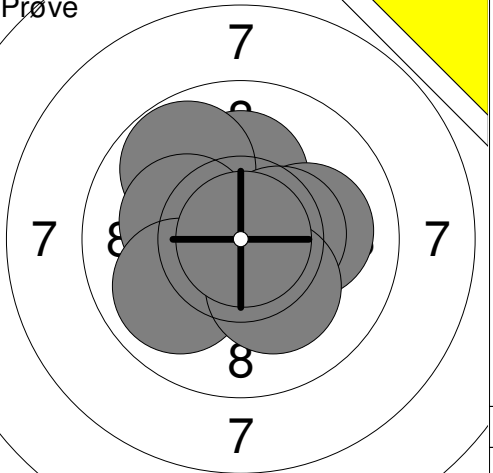
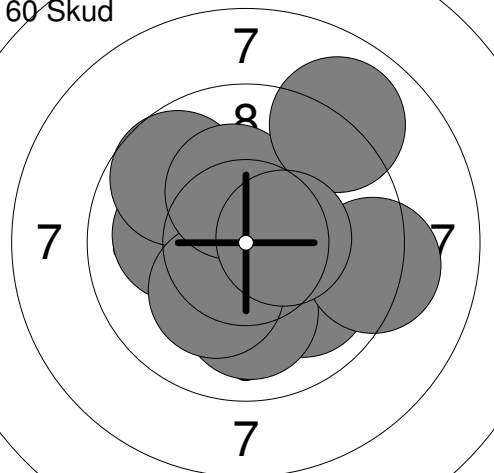
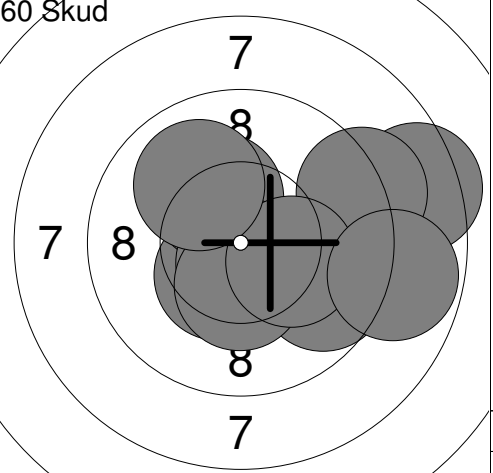
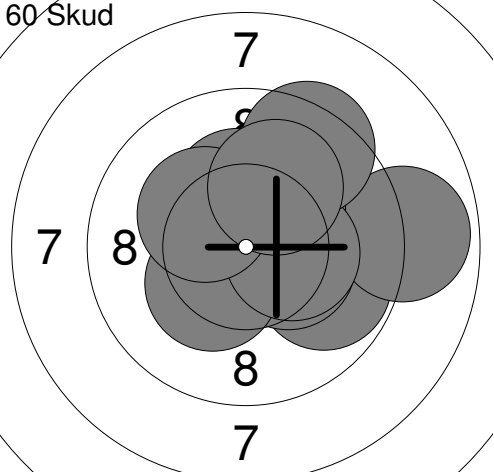
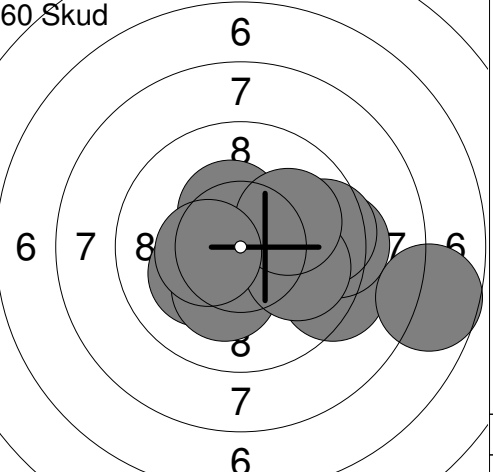
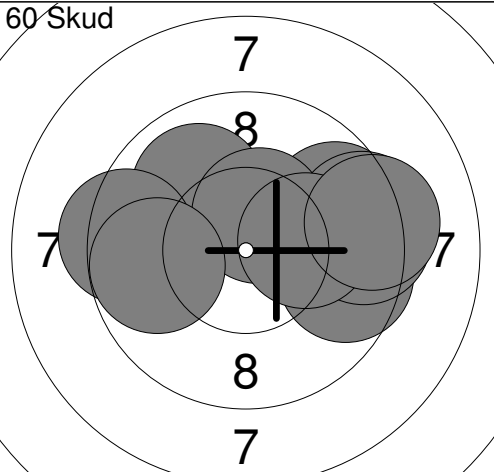
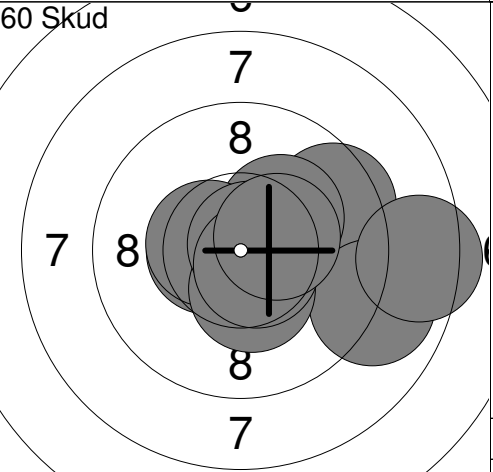
Hold	Skive	Niels Laustsen	
10m	DSB/ASF 2	H	R
19.01.2013	DIF 4. runde	Aalborg Skyttekreds	
Prøve		1: 9.3 ↘ 2: 8.3 ↙ 3: 9.0 ↘ 4: 10.0 ↙ 5: 9.9 ← 6: *10.7 ↓ 7: 10.1 → 8: *10.2 ↘ 9: 8.2 ↙ 10: 10.0 ↘ Serie 93.0 Total 0.0	Prøve  11: *10.2 ↑ 12: 10.1 → 13: 9.8 ↗ 14: *10.4 ← 15: *10.2 ← 16: *10.6 ↓ 17: 9.9 ↙ 18: *10.4 → 19: *10.2 ↘ 20: *10.9 → Serie 98.0 Total 0.0
60 Skud		1: 10.1 ← 2: 9.7 ↗ 3: 10.0 ↘ 4: 10.0 ↘ 5: 10.0 ↓ 6: *10.2 ↘ 7: *10.3 ↑ 8: 9.0 ↗ 9: 9.2 → 10: *10.4 → Serie 97.0 Total 97.0	60 Skud  11: *10.4 ↘ 12: *10.3 ↗ 13: 8.4 → 14: 9.7 ↘ 15: *10.7 ↓ 16: 9.2 ↗ 17: *10.4 ↓ 18: *10.2 ↘ 19: 10.0 ↗ 20: 8.8 → Serie 94.0 Total 191.0
60 Skud		21: 9.8 → 22: 8.9 → 23: *10.4 → 24: *10.3 ↘ 25: *10.3 ↗ 26: *10.3 ↑ 27: *10.3 → 28: *10.3 ↗ 29: 9.4 ↗ 30: 10.1 ↗ Serie 96.0 Total 287.0	60 Skud  31: 9.3 → 32: 9.4 → 33: *10.4 ↑ 34: *10.2 ↙ 35: 9.5 → 36: *10.2 ↓ 37: 9.9 → 38: 10.1 → 39: 7.7 → 40: *10.4 ← Serie 93.0 Total 380.0
60 Skud		41: 9.7 → 42: 10.0 ↗ 43: 9.4 ← 44: 9.6 → 45: *10.5 ↗ 46: 9.4 → 47: 9.8 ← 48: 9.4 → 49: *10.2 → 50: 9.2 → Serie 93.0 Total 473.0	60 Skud  51: *10.5 ← 52: 9.5 ↗ 53: 8.9 → 54: 8.4 → 55: *10.2 ↗ 56: *10.5 ← 57: *10.4 ↓ 58: *10.8 ↗ 59: *10.6 ↘ 60: *10.4 → Serie 95.0 Total 568.0

Hold	Skive	Lars Ørum	
2	1		
10m	Aalborg Skyttekreds	H	R
19.01.2013	DIF 4. runde	Aalborg Skyttekreds	
Prøve		1: *10.7 → 2: 10.1 → 3: *10.2 ↓ 4: *10.2 ↓ 5: *10.4 ↓ 6: 9.9 ↑ 7: 9.4 ↗ 8: *10.3 → 9: *10.5 ↗ 10: 9.5 ↗ Serie 97.0 Total 0.0	Prøve  11: *10.7 ↓ 12: *10.5 → 13: *10.4 ↑ Serie 30.0 Total 0.0
60 Skud		1: 9.8 ← 2: 9.8 ↑ 3: *10.3 ↗ 4: *10.4 ↗ 5: *10.7 ↑ 6: *10.5 ↓ 7: *10.8 ↗ 8: 9.7 ↓ 9: 9.6 ↗ 10: *10.8 ↑ Serie 96.0 Total 96.0	60 Skud  11: *10.6 ↗ 12: *10.4 ↓ 13: 10.1 ↓ 14: *10.5 ↑ 15: *10.2 ↗ 16: 10.0 ← 17: 10.1 ← 18: *10.7 ↗ 19: 9.8 ↑ 20: *10.3 ↗ Serie 99.0 Total 195.0
60 Skud		21: 10.1 → 22: *10.4 ← 23: *10.7 ↓ 24: 9.8 ↓ 25: *10.4 ↑ 26: *10.5 ↓ 27: 9.8 ↑ 28: 10.0 ↗ 29: *10.4 ← 30: *10.3 ← Serie 98.0 Total 293.0	60 Skud  31: 9.6 → 32: *10.9 ← 33: *10.6 ↓ 34: *10.3 ↓ 35: *10.7 ↗ 36: *10.7 ↑ 37: *10.3 → 38: *10.6 ← 39: 9.6 ↗ 40: *10.6 ↗ Serie 98.0 Total 391.0
60 Skud		41: *10.5 ↓ 42: *10.3 ↓ 43: 10.0 ↑ 44: *10.4 ↑ 45: *10.6 ↗ 46: *10.9 ← 47: 10.1 ↗ 48: *10.7 → 49: *10.3 ↓ 50: *10.9 ↓ Serie 100.0 Total 491.0	60 Skud  51: *10.2 ← 52: *10.6 ↓ 53: *10.6 ↓ 54: *10.5 ↓ 55: 10.1 → 56: *10.2 ← 57: 10.1 → 58: *10.6 ← 59: *10.3 → 60: *10.5 ← Serie 100.0 Total 591.0

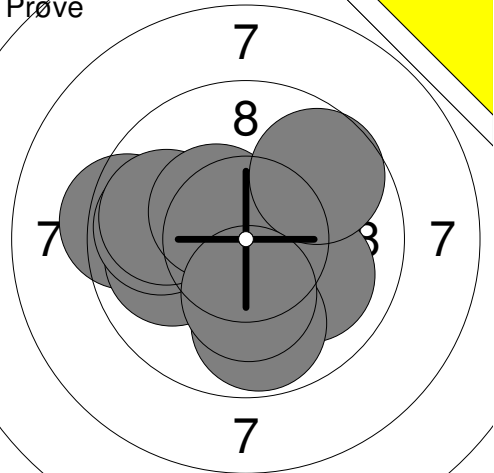
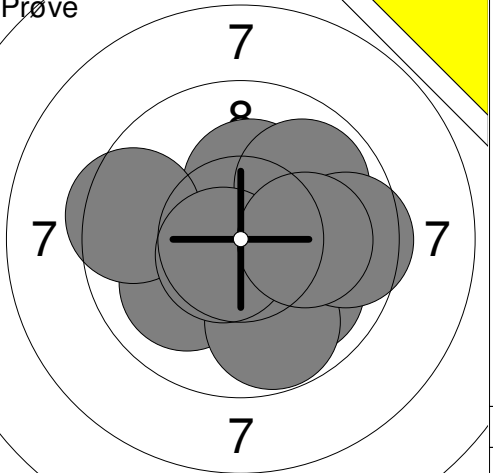
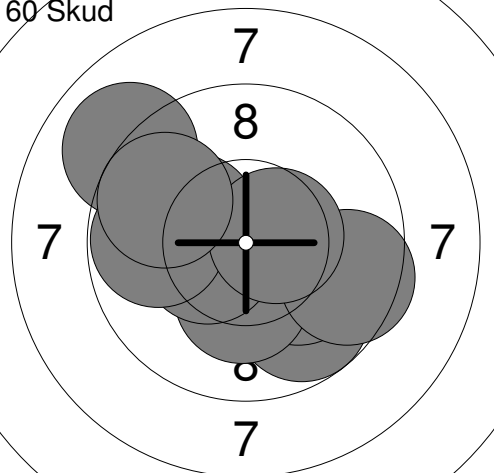
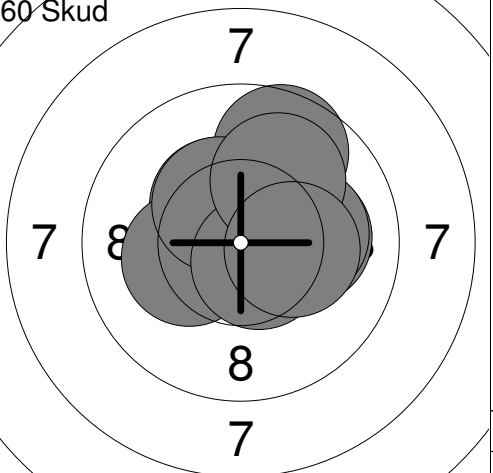
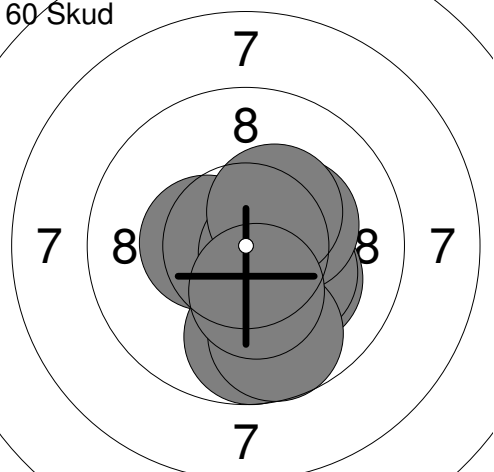
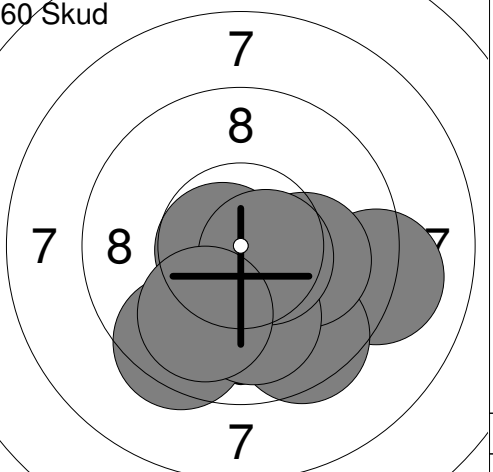
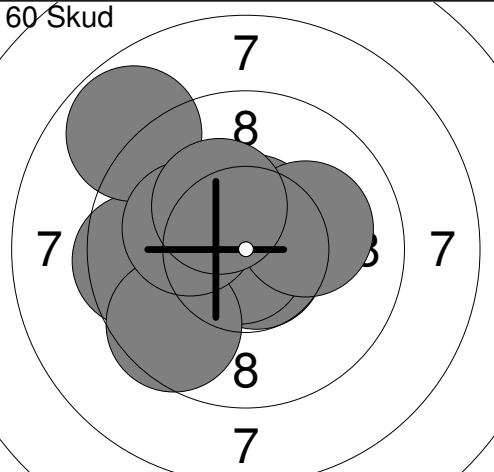
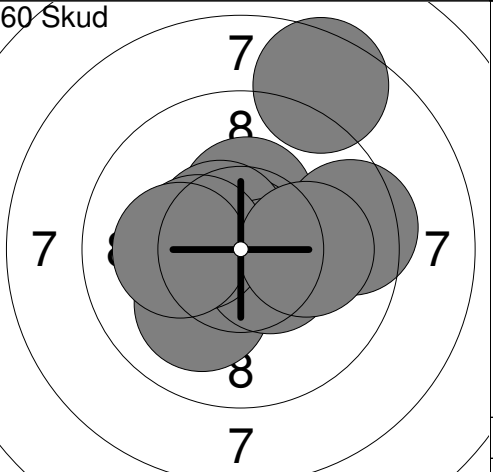
<p><b>Prøve</b></p> 	<p>1: *10.3 ← 2: 10.0 → 3: 9.4 ← 4: 9.8 ↓ 5: 9.9 ← 6: 9.8 ← 7: 9.9 ← 8: *10.4 ↗ 9: 9.7 ↗ 10: *10.2 ↓</p> <p>Serie 94.0 Total 0.0</p>	<p><b>Prøve</b></p> 	<p>11: 10.0 → 12: 10.0 ↙ 13: 9.8 ↓ 14: *10.8 ↗ 15: *10.2 ↑ 16: 9.5 ← 17: 9.9 ↗ 18: *10.6 ↙ 19: 9.6 → 20: 10.1 →</p> <p>Serie 96.0 Total 0.0</p>
<p><b>60 Skud</b></p> 	<p>1: *10.2 ← 2: 9.8 ↓ 3: 9.0 ↗ 4: 10.1 ↓ 5: *10.3 ↓ 6: *10.4 ← 7: 9.8 ← 8: 9.5 → 9: *10.5 → 10: 9.7 ↗</p> <p>Serie 95.0 Total 95.0</p>	<p><b>60 Skud</b></p> 	<p>11: *10.4 ↗ 12: 9.7 ↑ 13: 10.1 ↗ 14: *10.2 ← 15: 10.1 → 16: *10.4 ↗ 17: 10.1 → 18: *10.6 ↙ 19: 10.0 ↗ 20: *10.3 →</p> <p>Serie 99.0 Total 194.0</p>
<p><b>60 Skud</b></p> 	<p>21: *10.4 ← 22: *10.2 ↓ 23: *10.7 → 24: 9.8 ↓ 25: 9.8 ↓ 26: *10.3 ↓ 27: *10.3 → 28: 9.7 ↓ 29: *10.4 ↗ 30: *10.3 ↓</p> <p>Serie 97.0 Total 291.0</p>	<p><b>60 Skud</b></p> 	<p>31: 9.5 ↙ 32: 9.9 ↙ 33: *10.7 ← 34: *10.2 ↙ 35: 9.1 → 36: 9.5 ↙ 37: 10.1 → 38: 10.0 ↓ 39: *10.6 → 40: 9.9 ↙</p> <p>Serie 95.0 Total 386.0</p>
<p><b>60 Skud</b></p> 	<p>41: *10.6 ↑ 42: *10.5 ↗ 43: *10.7 ↙ 44: *10.8 ↙ 45: 10.1 → 46: 9.5 ← 47: 9.6 ↙ 48: 8.8 ↗ 49: *10.2 ← 50: *10.3 ↗</p> <p>Serie 96.0 Total 482.0</p>	<p><b>60 Skud</b></p> 	<p>51: 10.1 ↙ 52: *10.4 ↑ 53: *10.9 ↑ 54: *10.6 ↗ 55: *10.5 ↙ 56: *10.4 ← 57: 8.5 ↗ 58: 9.5 → 59: *10.2 ← 60: 10.1 →</p> <p>Serie 97.0 Total 579.0</p>

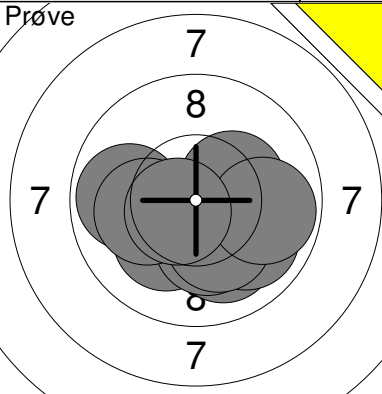
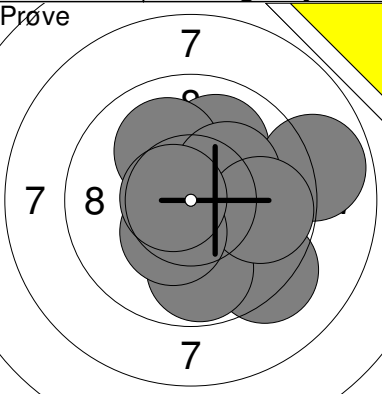
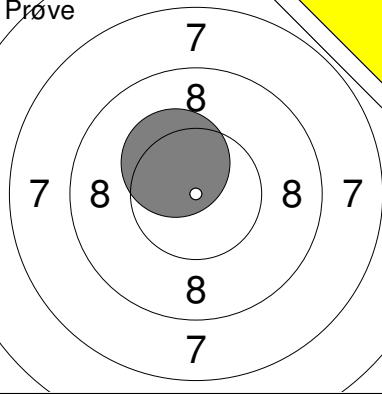
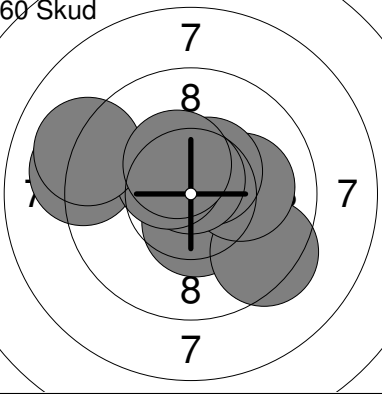
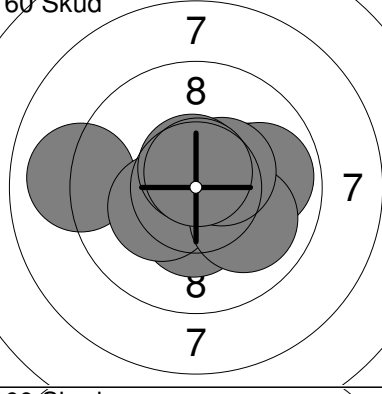
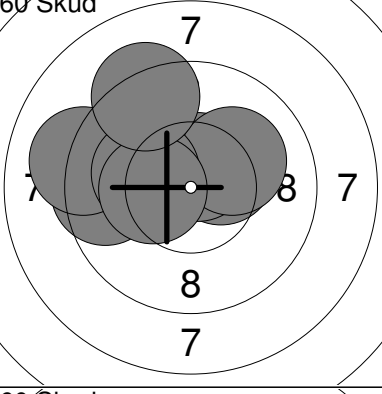
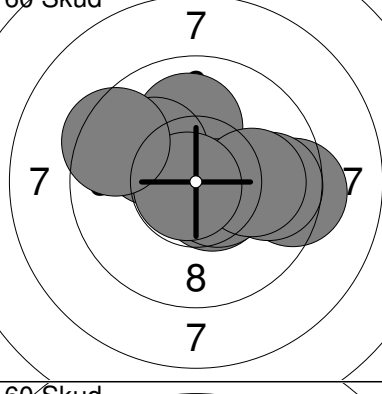
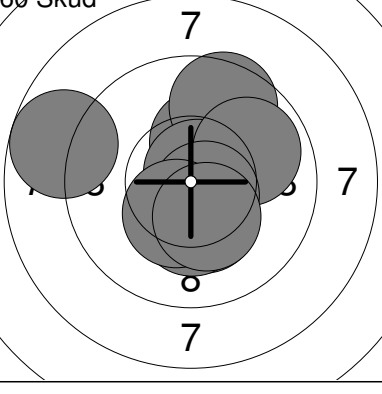
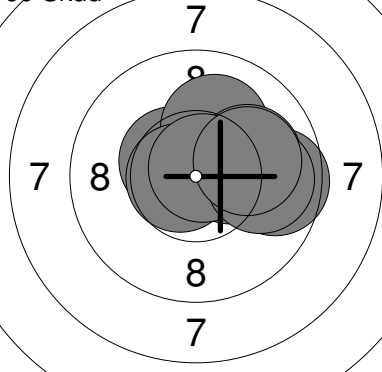
Hold	Skive	Kristinna Olsen	
2	3		
10m	Aalborg Skyttekreds	DJ	R
19.01.2013	DIF 4. runde	Aalborg Skyttekreds	
Prøve		1: 10.0 ↘ 2: *10.2 ↘ 3: *10.2 ↘ 4: 9.8 ← 5: 9.9 ↘ 6: 10.1 ← 7: *10.3 → 8: *10.2 ↘ 9: 9.8 → 10: *10.6 ←	Prøve
		11: 10.0 ↗ 12: 9.8 → 13: 10.0 ↗ 14: 8.9 → 15: *10.2 ↗ 16: 9.3 ↘ 17: 9.8 ↘ 18: 9.8 → 19: *10.4 ↘ 20: *10.7 ←	
	Serie 97.0 Total 0.0	Serie 94.0 Total 0.0	
Prøve		21: *10.3 ↗	60 Skud
		1: *10.5 ↘ 2: *10.5 ↗ 3: 9.4 ↘ 4: 10.1 → 5: *10.5 ↗ 6: *10.7 ↗ 7: 9.1 ← 8: *10.5 ↗ 9: 9.1 ↗ 10: *10.4 ↗	
	Serie 10.0 Total 0.0	Serie 97.0 Total 97.0	
60 Skud		11: 10.1 → 12: 9.9 → 13: *10.4 ↘ 14: *10.7 → 15: 9.0 ← 16: *10.3 ← 17: 10.0 ↘ 18: *10.5 ↗ 19: *10.6 ↗ 20: *10.7 ↗	60 Skud
		21: *10.4 ↗ 22: 9.6 ← 23: *10.6 ↗ 24: 10.1 ↗ 25: 9.7 ← 26: 9.5 ← 27: 9.1 ← 28: *10.2 ← 29: *10.3 ← 30: 9.3 ↗	
	Serie 98.0 Total 195.0	Serie 95.0 Total 290.0	
60 Skud		31: 9.3 → 32: *10.6 ↘ 33: *10.7 ↘ 34: 9.7 → 35: 10.0 ↗ 36: *10.5 ↘ 37: 10.1 ↗ 38: 10.0 → 39: *10.8 ← 40: 9.5 ↗	60 Skud
		41: *10.3 ↗ 42: *10.3 ↘ 43: 8.7 ← 44: 9.6 ↗ 45: *10.3 ↘ 46: *10.8 ↗ 47: 9.9 ↗ 48: *10.6 ↘ 49: *10.4 ↘ 50: *10.3 ↘	
	Serie 97.0 Total 387.0	Serie 96.0 Total 483.0	
60 Skud		51: *10.4 → 52: *10.2 → 53: 9.6 → 54: *10.5 ↗ 55: 10.1 ↗ 56: 10.1 → 57: *10.7 ← 58: *10.8 ↗ 59: 9.9 → 60: 10.1 →	
	Serie 98.0 Total 581.0		

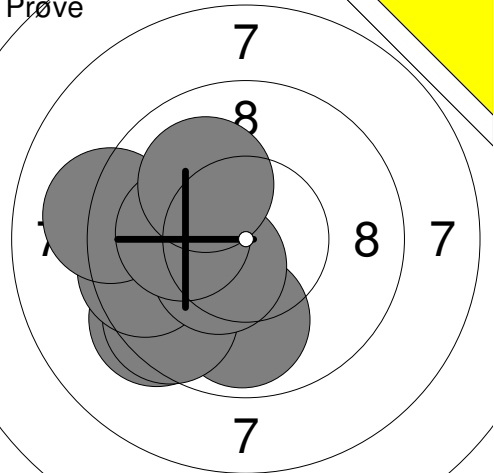
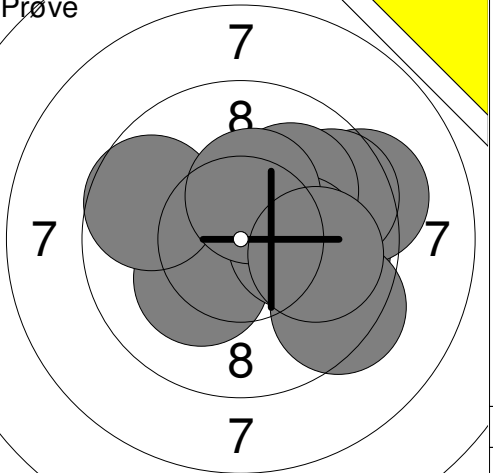
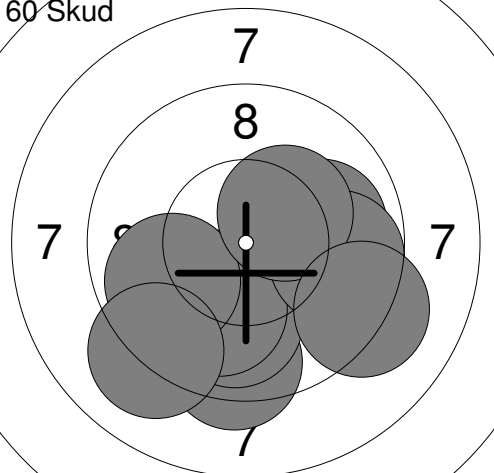
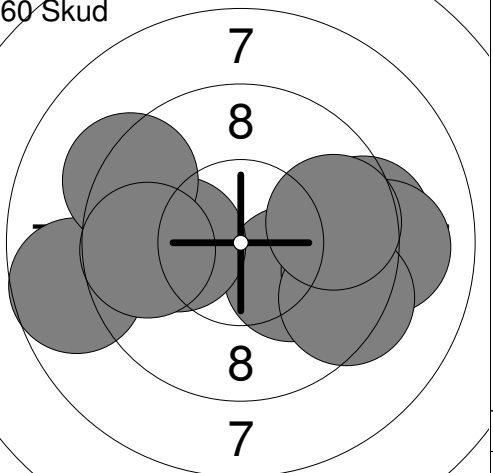
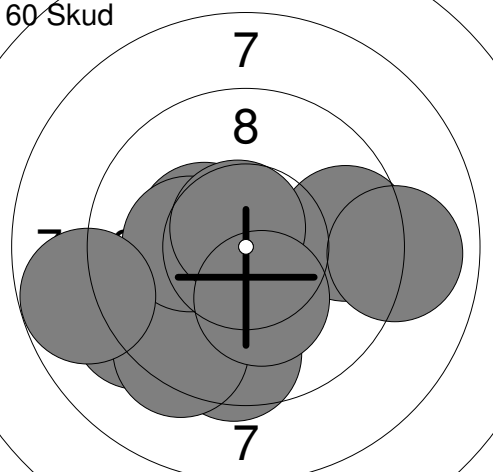
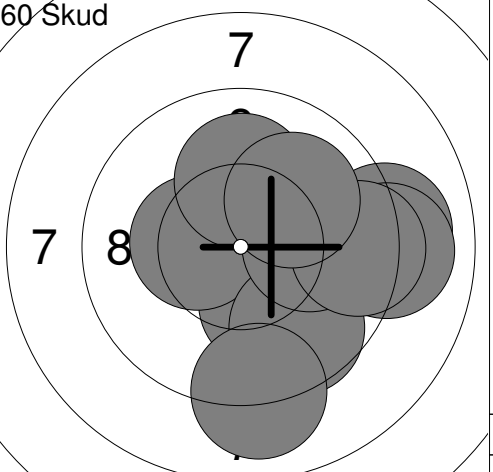
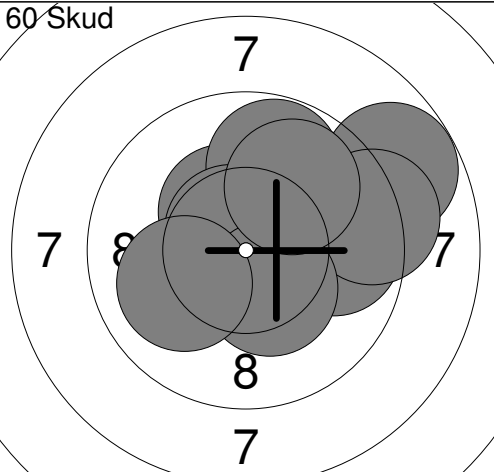
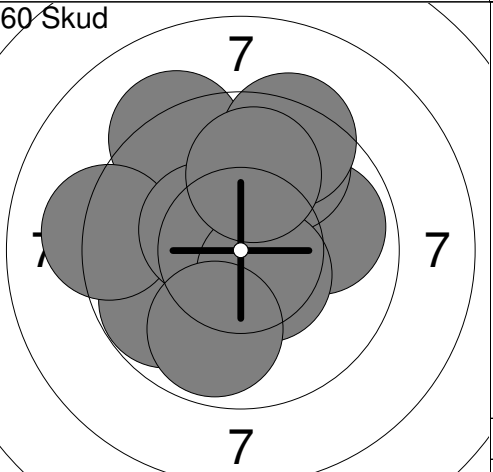
Hold	Skive	Bettina Jakobsen	
2	4	DSB/ASF 2	D R
10m		DIF 4. runde	Aalborg Skyttekreds
19.01.2013			
Prøve		1: 10.1 ← 2: 10.0 ← 3: 9.4 ↙ 4: 9.9 ↓ 5: 9.5 ↙ 6: 9.6 ← 7: *10.4 ↙ 8: 9.1 ← 9: 10.1 ← 10: 10.1 ↗ Serie 95.0 Total 0.0	Prøve  11: 9.9 → 12: 9.3 → 13: 9.4 ↘ 14: *10.2 ↙ 15: 9.6 → 16: 9.7 ← 17: 10.0 ↗ 18: *10.2 → 19: *10.4 ↑ 20: 9.9 → Serie 94.0 Total 0.0
60 Skud		1: 9.4 ↓ 2: *10.2 ↓ 3: 9.9 ↓ 4: 10.0 ↓ 5: 10.0 → 6: 9.7 → 7: 9.9 ← 8: *10.3 ↗ 9: 9.2 ↘ 10: 9.1 ↙ Serie 94.0 Total 94.0	60 Skud  11: 8.7 ← 12: *10.2 ↘ 13: 9.5 → 14: 10.1 ← 15: 9.3 ↗ 16: 9.3 → 17: 9.1 → 18: 9.4 ↘ 19: 9.7 → 20: 9.7 ← Serie 91.0 Total 185.0
60 Skud		21: 9.2 ← 22: *10.4 ← 23: 9.5 ↓ 24: 9.3 ↙ 25: *10.2 ← 26: 8.8 ← 27: 9.6 → 28: *10.7 ↗ 29: 9.0 → 30: *10.2 ↓ Serie 93.0 Total 278.0	60 Skud  31: 10.1 ↘ 32: *10.4 ← 33: 9.0 → 34: 9.7 ↘ 35: 10.0 → 36: 10.1 ↑ 37: 9.0 → 38: 9.4 → 39: 10.0 ↗ 40: 9.0 ↓ Serie 95.0 Total 373.0
60 Skud		41: 9.7 ↗ 42: 8.8 ↗ 43: 9.8 → 44: *10.4 ↗ 45: 9.2 → 46: 9.8 ↗ 47: *10.6 ↗ 48: *10.4 ↘ 49: 9.9 ↗ 50: 10.0 ← Serie 93.0 Total 466.0	60 Skud  51: 9.8 ← 52: 9.2 ↗ 53: 9.2 ← 54: *10.4 ↗ 55: 9.9 → 56: 9.7 ↗ 57: *10.5 ↘ 58: 9.9 ↘ 59: 9.4 ↗ 60: 9.9 ↑ Serie 92.0 Total 558.0

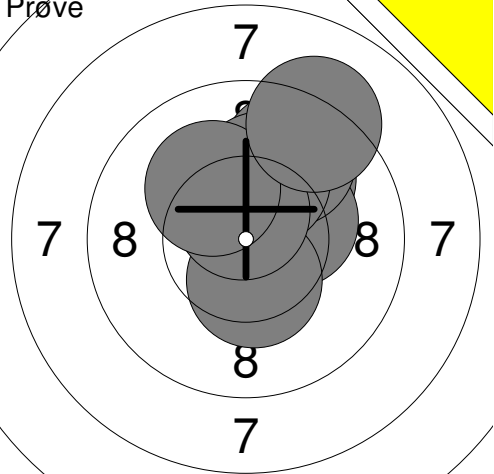
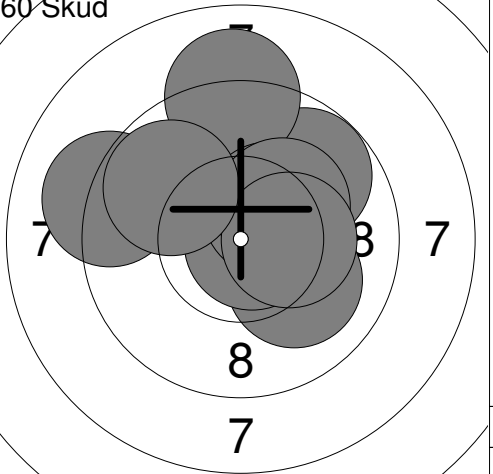

Prøve		Prøve																																																																									
	<table border="1" style="width:100%; border-collapse: collapse;"> <tr><td>1:</td><td>*10.6</td><td>↘</td></tr> <tr><td>2:</td><td>9.6</td><td>→</td></tr> <tr><td>3:</td><td>9.5</td><td>→</td></tr> <tr><td>4:</td><td>9.4</td><td>→</td></tr> <tr><td>5:</td><td>*10.5</td><td>↗</td></tr> <tr><td>6:</td><td>*10.5</td><td>↘</td></tr> <tr><td>7:</td><td>10.1</td><td>←</td></tr> <tr><td>8:</td><td>*10.2</td><td>↗</td></tr> <tr><td>9:</td><td>*10.6</td><td>↑</td></tr> <tr><td>10:</td><td>10.1</td><td>↘</td></tr> <tr><td colspan="2">Serie</td><td>97.0</td></tr> <tr><td colspan="2">Total</td><td>0.0</td></tr> </table>	1:	*10.6	↘	2:	9.6	→	3:	9.5	→	4:	9.4	→	5:	*10.5	↗	6:	*10.5	↘	7:	10.1	←	8:	*10.2	↗	9:	*10.6	↑	10:	10.1	↘	Serie		97.0	Total		0.0		<table border="1" style="width:100%; border-collapse: collapse;"> <tr><td>11:</td><td>*10.2</td><td>↘</td></tr> <tr><td>12:</td><td>9.3</td><td>↗</td></tr> <tr><td>13:</td><td>9.9</td><td>←</td></tr> <tr><td>14:</td><td>*10.4</td><td>↗</td></tr> <tr><td>15:</td><td>9.8</td><td>↗</td></tr> <tr><td>16:</td><td>*10.2</td><td>↗</td></tr> <tr><td colspan="2">Serie</td><td>57.0</td></tr> <tr><td colspan="2">Total</td><td>0.0</td></tr> </table>	11:	*10.2	↘	12:	9.3	↗	13:	9.9	←	14:	*10.4	↗	15:	9.8	↗	16:	*10.2	↗	Serie		57.0	Total		0.0												
1:	*10.6	↘																																																																									
2:	9.6	→																																																																									
3:	9.5	→																																																																									
4:	9.4	→																																																																									
5:	*10.5	↗																																																																									
6:	*10.5	↘																																																																									
7:	10.1	←																																																																									
8:	*10.2	↗																																																																									
9:	*10.6	↑																																																																									
10:	10.1	↘																																																																									
Serie		97.0																																																																									
Total		0.0																																																																									
11:	*10.2	↘																																																																									
12:	9.3	↗																																																																									
13:	9.9	←																																																																									
14:	*10.4	↗																																																																									
15:	9.8	↗																																																																									
16:	*10.2	↗																																																																									
Serie		57.0																																																																									
Total		0.0																																																																									
	<table border="1" style="width:100%; border-collapse: collapse;"> <tr><td>1:</td><td>9.4</td><td>←</td></tr> <tr><td>2:</td><td>*10.4</td><td>←</td></tr> <tr><td>3:</td><td>*10.6</td><td>↗</td></tr> <tr><td>4:</td><td>9.7</td><td>↑</td></tr> <tr><td>5:</td><td>10.0</td><td>→</td></tr> <tr><td>6:</td><td>*10.4</td><td>→</td></tr> <tr><td>7:</td><td>*10.5</td><td>→</td></tr> <tr><td>8:</td><td>*10.8</td><td>↑</td></tr> <tr><td>9:</td><td>8.7</td><td>↗</td></tr> <tr><td>10:</td><td>*10.5</td><td>↑</td></tr> <tr><td colspan="2">Serie</td><td>96.0</td></tr> <tr><td colspan="2">Total</td><td>96.0</td></tr> </table>	1:	9.4	←	2:	*10.4	←	3:	*10.6	↗	4:	9.7	↑	5:	10.0	→	6:	*10.4	→	7:	*10.5	→	8:	*10.8	↑	9:	8.7	↗	10:	*10.5	↑	Serie		96.0	Total		96.0		<table border="1" style="width:100%; border-collapse: collapse;"> <tr><td>11:</td><td>*10.6</td><td>↘</td></tr> <tr><td>12:</td><td>*10.4</td><td>←</td></tr> <tr><td>13:</td><td>9.7</td><td>↗</td></tr> <tr><td>14:</td><td>9.7</td><td>↘</td></tr> <tr><td>15:</td><td>9.8</td><td>←</td></tr> <tr><td>16:</td><td>8.8</td><td>↗</td></tr> <tr><td>17:</td><td>10.0</td><td>↗</td></tr> <tr><td>18:</td><td>*10.7</td><td>←</td></tr> <tr><td>19:</td><td>9.1</td><td>↗</td></tr> <tr><td>20:</td><td>9.8</td><td>↗</td></tr> <tr><td colspan="2">Serie</td><td>93.0</td></tr> <tr><td colspan="2">Total</td><td>189.0</td></tr> </table>	11:	*10.6	↘	12:	*10.4	←	13:	9.7	↗	14:	9.7	↘	15:	9.8	←	16:	8.8	↗	17:	10.0	↗	18:	*10.7	←	19:	9.1	↗	20:	9.8	↗	Serie		93.0	Total		189.0
1:	9.4	←																																																																									
2:	*10.4	←																																																																									
3:	*10.6	↗																																																																									
4:	9.7	↑																																																																									
5:	10.0	→																																																																									
6:	*10.4	→																																																																									
7:	*10.5	→																																																																									
8:	*10.8	↑																																																																									
9:	8.7	↗																																																																									
10:	*10.5	↑																																																																									
Serie		96.0																																																																									
Total		96.0																																																																									
11:	*10.6	↘																																																																									
12:	*10.4	←																																																																									
13:	9.7	↗																																																																									
14:	9.7	↘																																																																									
15:	9.8	←																																																																									
16:	8.8	↗																																																																									
17:	10.0	↗																																																																									
18:	*10.7	←																																																																									
19:	9.1	↗																																																																									
20:	9.8	↗																																																																									
Serie		93.0																																																																									
Total		189.0																																																																									
	<table border="1" style="width:100%; border-collapse: collapse;"> <tr><td>21:</td><td>10.1</td><td>↑</td></tr> <tr><td>22:</td><td>9.2</td><td>↗</td></tr> <tr><td>23:</td><td>8.7</td><td>↗</td></tr> <tr><td>24:</td><td>9.8</td><td>↑</td></tr> <tr><td>25:</td><td>10.1</td><td>↗</td></tr> <tr><td>26:</td><td>9.0</td><td>↑</td></tr> <tr><td>27:</td><td>*10.3</td><td>↑</td></tr> <tr><td>28:</td><td>8.7</td><td>→</td></tr> <tr><td>29:</td><td>*10.2</td><td>↑</td></tr> <tr><td>30:</td><td>9.0</td><td>→</td></tr> <tr><td colspan="2">Serie</td><td>92.0</td></tr> <tr><td colspan="2">Total</td><td>281.0</td></tr> </table>	21:	10.1	↑	22:	9.2	↗	23:	8.7	↗	24:	9.8	↑	25:	10.1	↗	26:	9.0	↑	27:	*10.3	↑	28:	8.7	→	29:	*10.2	↑	30:	9.0	→	Serie		92.0	Total		281.0		<table border="1" style="width:100%; border-collapse: collapse;"> <tr><td>31:</td><td>*10.9</td><td>←</td></tr> <tr><td>32:</td><td>9.2</td><td>↘</td></tr> <tr><td>33:</td><td>*10.7</td><td>↘</td></tr> <tr><td>34:</td><td>9.7</td><td>←</td></tr> <tr><td>35:</td><td>*10.4</td><td>→</td></tr> <tr><td>36:</td><td>10.1</td><td>↘</td></tr> <tr><td>37:</td><td>*10.6</td><td>↗</td></tr> <tr><td>38:</td><td>*10.7</td><td>↘</td></tr> <tr><td>39:</td><td>*10.8</td><td>↘</td></tr> <tr><td>40:</td><td>10.0</td><td>↑</td></tr> <tr><td colspan="2">Serie</td><td>98.0</td></tr> <tr><td colspan="2">Total</td><td>379.0</td></tr> </table>	31:	*10.9	←	32:	9.2	↘	33:	*10.7	↘	34:	9.7	←	35:	*10.4	→	36:	10.1	↘	37:	*10.6	↗	38:	*10.7	↘	39:	*10.8	↘	40:	10.0	↑	Serie		98.0	Total		379.0
21:	10.1	↑																																																																									
22:	9.2	↗																																																																									
23:	8.7	↗																																																																									
24:	9.8	↑																																																																									
25:	10.1	↗																																																																									
26:	9.0	↑																																																																									
27:	*10.3	↑																																																																									
28:	8.7	→																																																																									
29:	*10.2	↑																																																																									
30:	9.0	→																																																																									
Serie		92.0																																																																									
Total		281.0																																																																									
31:	*10.9	←																																																																									
32:	9.2	↘																																																																									
33:	*10.7	↘																																																																									
34:	9.7	←																																																																									
35:	*10.4	→																																																																									
36:	10.1	↘																																																																									
37:	*10.6	↗																																																																									
38:	*10.7	↘																																																																									
39:	*10.8	↘																																																																									
40:	10.0	↑																																																																									
Serie		98.0																																																																									
Total		379.0																																																																									
	<table border="1" style="width:100%; border-collapse: collapse;"> <tr><td>41:</td><td>9.7</td><td>↘</td></tr> <tr><td>42:</td><td>9.0</td><td>→</td></tr> <tr><td>43:</td><td>*10.3</td><td>↗</td></tr> <tr><td>44:</td><td>9.6</td><td>↘</td></tr> <tr><td>45:</td><td>*10.3</td><td>→</td></tr> <tr><td>46:</td><td>9.7</td><td>↗</td></tr> <tr><td>47:</td><td>9.3</td><td>↗</td></tr> <tr><td>48:</td><td>9.5</td><td>↗</td></tr> <tr><td>49:</td><td>10.1</td><td>←</td></tr> <tr><td>50:</td><td>*10.4</td><td>←</td></tr> <tr><td colspan="2">Serie</td><td>94.0</td></tr> <tr><td colspan="2">Total</td><td>473.0</td></tr> </table>	41:	9.7	↘	42:	9.0	→	43:	*10.3	↗	44:	9.6	↘	45:	*10.3	→	46:	9.7	↗	47:	9.3	↗	48:	9.5	↗	49:	10.1	←	50:	*10.4	←	Serie		94.0	Total		473.0		<table border="1" style="width:100%; border-collapse: collapse;"> <tr><td>51:</td><td>*10.7</td><td>↗</td></tr> <tr><td>52:</td><td>10.0</td><td>←</td></tr> <tr><td>53:</td><td>9.7</td><td>←</td></tr> <tr><td>54:</td><td>10.1</td><td>↗</td></tr> <tr><td>55:</td><td>*10.4</td><td>↘</td></tr> <tr><td>56:</td><td>*10.5</td><td>↘</td></tr> <tr><td>57:</td><td>*10.3</td><td>↗</td></tr> <tr><td>58:</td><td>*10.5</td><td>↗</td></tr> <tr><td>59:</td><td>*10.5</td><td>↗</td></tr> <tr><td>60:</td><td>*10.5</td><td>↗</td></tr> <tr><td colspan="2">Serie</td><td>99.0</td></tr> <tr><td colspan="2">Total</td><td>572.0</td></tr> </table>	51:	*10.7	↗	52:	10.0	←	53:	9.7	←	54:	10.1	↗	55:	*10.4	↘	56:	*10.5	↘	57:	*10.3	↗	58:	*10.5	↗	59:	*10.5	↗	60:	*10.5	↗	Serie		99.0	Total		572.0
41:	9.7	↘																																																																									
42:	9.0	→																																																																									
43:	*10.3	↗																																																																									
44:	9.6	↘																																																																									
45:	*10.3	→																																																																									
46:	9.7	↗																																																																									
47:	9.3	↗																																																																									
48:	9.5	↗																																																																									
49:	10.1	←																																																																									
50:	*10.4	←																																																																									
Serie		94.0																																																																									
Total		473.0																																																																									
51:	*10.7	↗																																																																									
52:	10.0	←																																																																									
53:	9.7	←																																																																									
54:	10.1	↗																																																																									
55:	*10.4	↘																																																																									
56:	*10.5	↘																																																																									
57:	*10.3	↗																																																																									
58:	*10.5	↗																																																																									
59:	*10.5	↗																																																																									
60:	*10.5	↗																																																																									
Serie		99.0																																																																									
Total		572.0																																																																									

<p>Prøve</p> 	<p>1: *10.7 →</p> <p>2: 10.0 ↗</p> <p>3: *10.3 →</p> <p>4: 9.7 ↗</p> <p>5: 10.1 ↑</p> <p>6: *10.4 ↓</p> <p>7: *10.6 ↑</p> <p>8: *10.2 ↗</p> <p>9: 9.2 ↗</p> <p>Serie 88.0</p> <p>Total 0.0</p>	<p>60 Skud</p>  <p>1: 10.1 ↑</p> <p>2: 9.8 ↗</p> <p>3: 10.1 ↘</p> <p>4: 9.1 ↑</p> <p>5: 9.1 ←</p> <p>6: *10.8 →</p> <p>7: *10.4 ↗</p> <p>8: *10.2 ↗</p> <p>9: *10.3 →</p> <p>10: 9.8 ↖</p> <p>Serie 96.0</p> <p>Total 96.0</p>
---	--	--

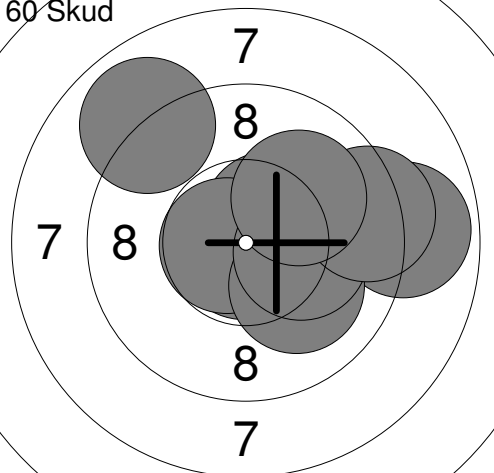
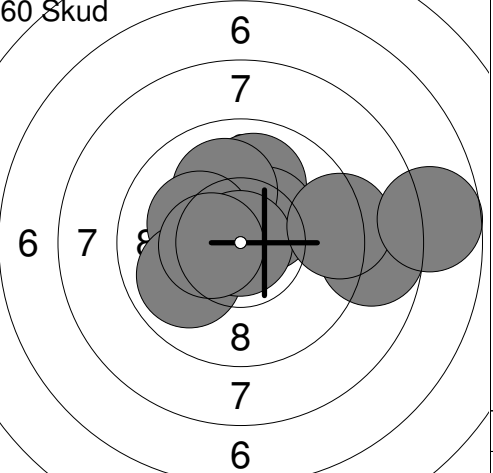
<p>60 Skud</p> 	<p>11: 8.9 →</p> <p>12: *10.8 ↓</p> <p>13: *10.5 ↗</p> <p>14: *10.7 ←</p> <p>15: 10.1 ↘</p> <p>16: 10.0 →</p> <p>17: *10.2 →</p> <p>18: 9.3 →</p> <p>19: 10.0 ↗</p> <p>20: 8.9 ↗</p> <p>Serie 95.0</p> <p>Total 191.0</p>	<p>60 Skud</p>  <p>21: 8.7 →</p> <p>22: 10.0 ↑</p> <p>23: *10.4 ↗</p> <p>24: 10.0 ↑</p> <p>25: *10.2 ←</p> <p>26: 9.9 ←</p> <p>27: *10.9 ↓</p> <p>28: 9.3 →</p> <p>29: *10.5 ←</p> <p>30: 7.7 →</p> <p>Serie 93.0</p> <p>Total 284.0</p>
--	---	---

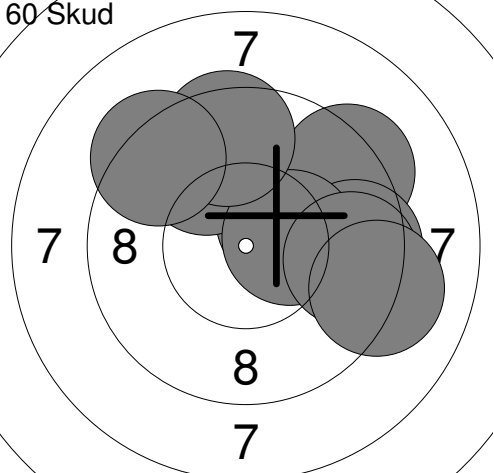
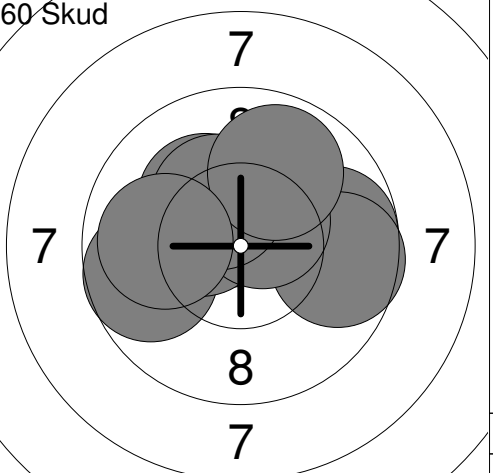
<p>60 Skud</p> 	<p>31: *10.3 ↗</p> <p>32: *10.2 ↗</p> <p>33: 9.8 ↗</p> <p>34: 9.3 ↗</p> <p>35: 9.5 →</p> <p>36: *10.4 →</p> <p>37: 9.6 →</p> <p>38: 9.5 ↑</p> <p>39: 9.1 →</p> <p>40: 9.3 ↗</p> <p>Serie 93.0</p> <p>Total 377.0</p>	<p>60 Skud</p>  <p>41: 9.7 ←</p> <p>42: *10.6 ↗</p> <p>43: 9.8 →</p> <p>44: *10.2 ↗</p> <p>45: *10.4 ←</p> <p>46: 9.7 →</p> <p>47: *10.5 ↗</p> <p>48: *10.3 ↗</p> <p>49: 9.9 ↗</p> <p>50: 9.9 ←</p> <p>Serie 95.0</p> <p>Total 472.0</p>
---	--	--

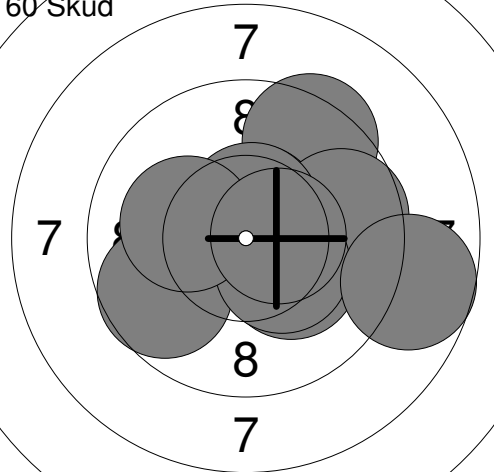
<p>60 Skud</p> 	<p>51: *10.2 ↘</p> <p>52: 9.7 ←</p> <p>53: 9.4 ↗</p> <p>54: *10.6 ↑</p> <p>55: 9.7 →</p> <p>56: *10.4 ↘</p> <p>57: *10.6 ↑</p> <p>58: *10.2 ←</p> <p>59: 8.7 →</p> <p>60: *10.5 →</p> <p>Serie 95.0</p> <p>Total 567.0</p>	
---	--	--

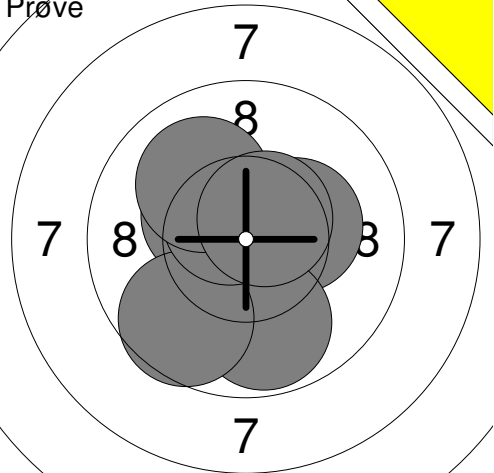
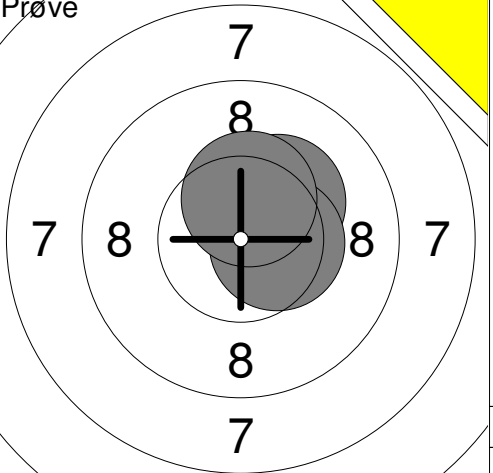
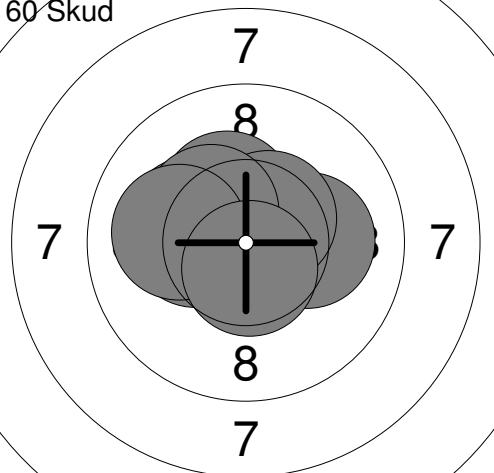
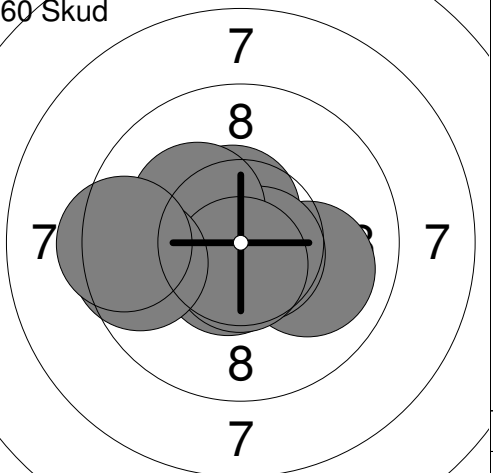
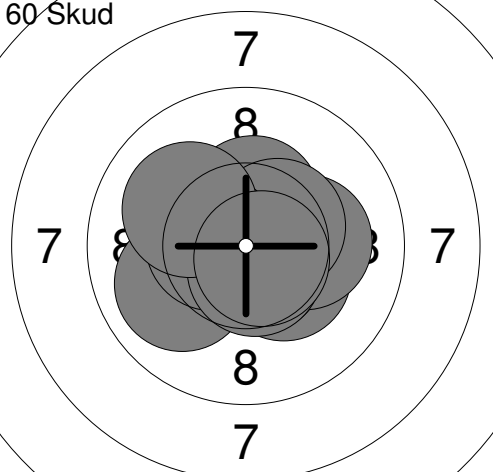
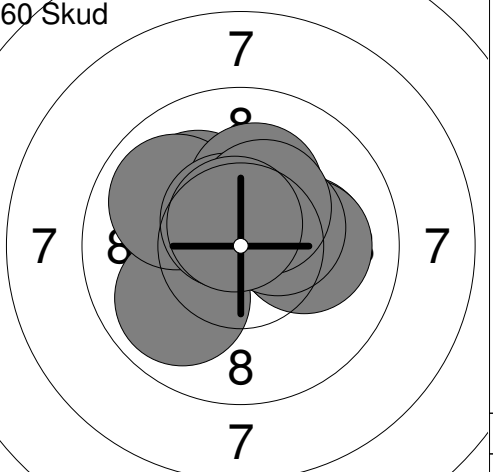
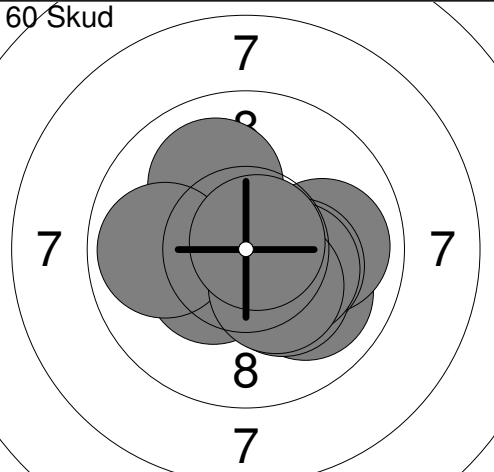
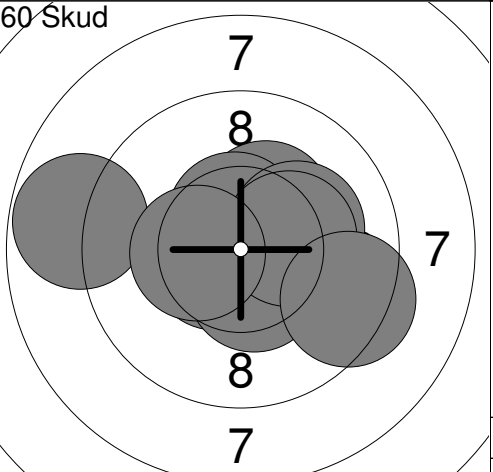

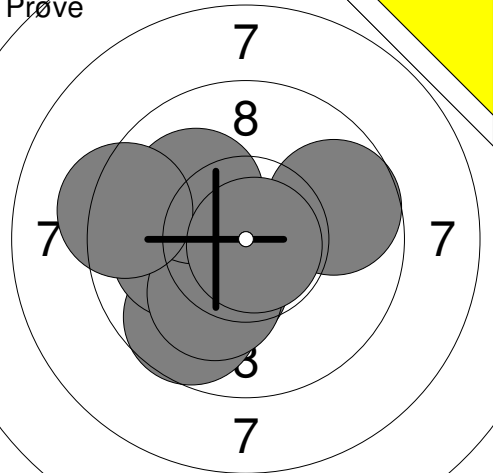
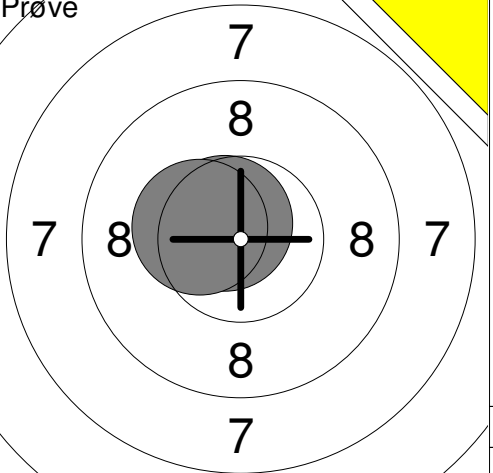
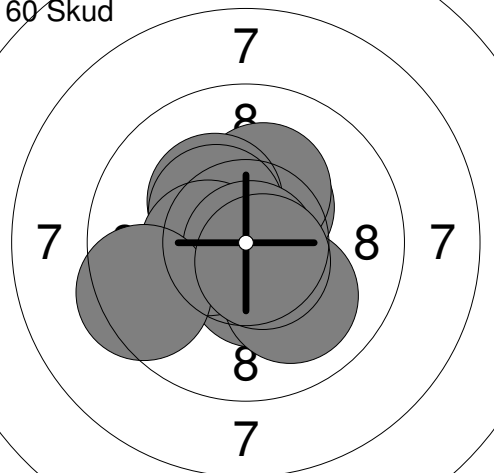
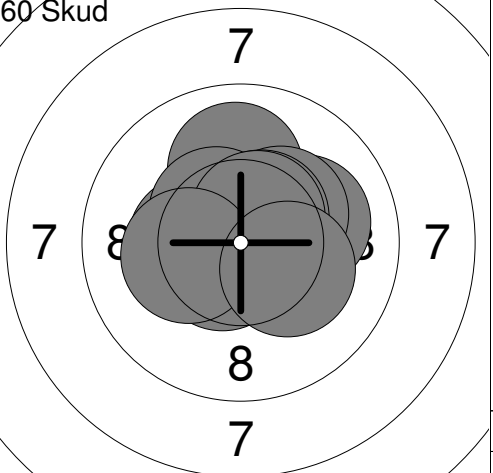
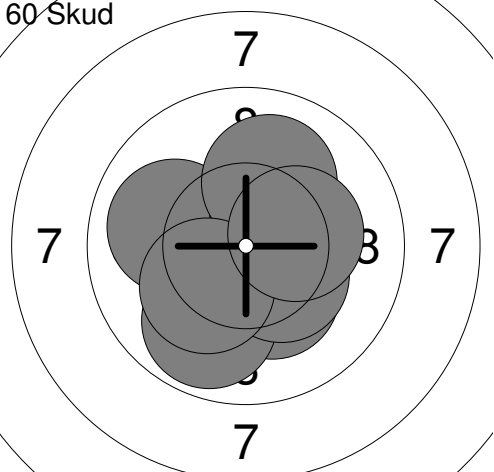
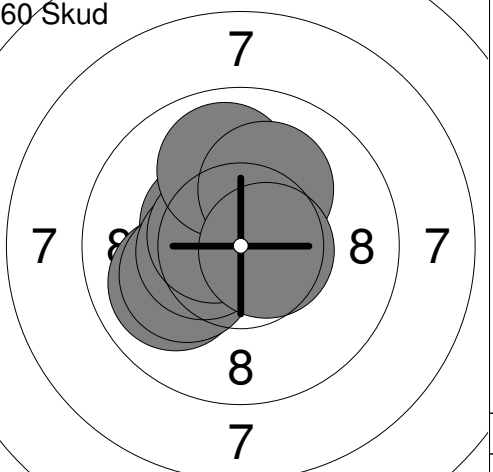
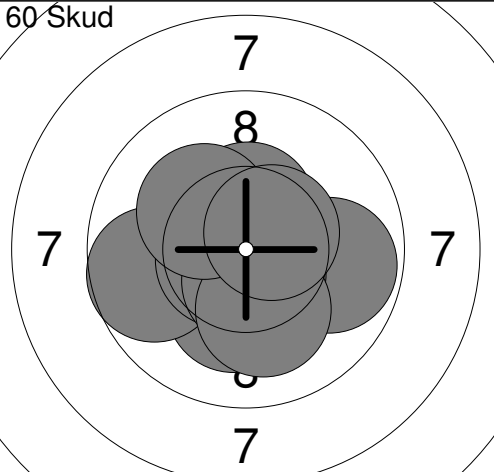
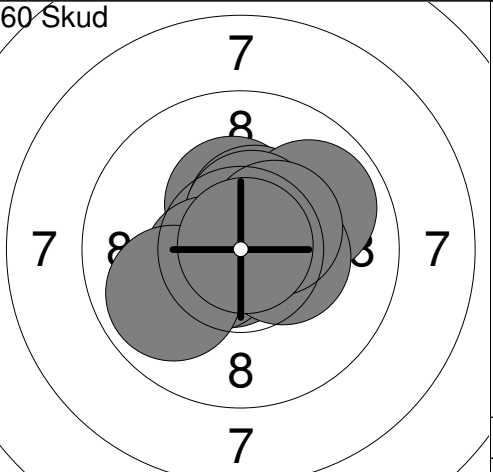
Prøve	Prøve																																																					
		<table style="width:100%; border-collapse: collapse;"> <tr><td>1: *10.3</td><td style="text-align:right;">→</td></tr> <tr><td>2: *10.4</td><td style="text-align:right;">↗</td></tr> <tr><td>3: *10.4</td><td style="text-align:right;">↗</td></tr> <tr><td>4: *10.8</td><td style="text-align:right;">↑</td></tr> <tr><td>5: 9.8</td><td style="text-align:right;">↓</td></tr> <tr><td>6: *10.6</td><td style="text-align:right;">↗</td></tr> <tr><td>7: 9.6</td><td style="text-align:right;">↘</td></tr> <tr><td>8: *10.6</td><td style="text-align:right;">↗</td></tr> <tr><td>9: 10.0</td><td style="text-align:right;">↗</td></tr> <tr><td>10: *10.6</td><td style="text-align:right;">↗</td></tr> <tr><td colspan="2"><hr/></td></tr> <tr><td>Serie</td><td style="text-align:right;">98.0</td></tr> <tr><td>Total</td><td style="text-align:right;">0.0</td></tr> </table>	1: *10.3	→	2: *10.4	↗	3: *10.4	↗	4: *10.8	↑	5: 9.8	↓	6: *10.6	↗	7: 9.6	↘	8: *10.6	↗	9: 10.0	↗	10: *10.6	↗	<hr/>		Serie	98.0	Total	0.0																										
1: *10.3	→																																																					
2: *10.4	↗																																																					
3: *10.4	↗																																																					
4: *10.8	↑																																																					
5: 9.8	↓																																																					
6: *10.6	↗																																																					
7: 9.6	↘																																																					
8: *10.6	↗																																																					
9: 10.0	↗																																																					
10: *10.6	↗																																																					
<hr/>																																																						
Serie	98.0																																																					
Total	0.0																																																					
		<table style="width:100%; border-collapse: collapse;"> <tr><td>11: *10.3</td><td style="text-align:right;">↗</td></tr> <tr><td>12: *10.5</td><td style="text-align:right;">→</td></tr> <tr><td>13: *10.4</td><td style="text-align:right;">↑</td></tr> <tr><td colspan="2"><hr/></td></tr> <tr><td>Serie</td><td style="text-align:right;">30.0</td></tr> <tr><td>Total</td><td style="text-align:right;">0.0</td></tr> </table> <table style="width:100%; border-collapse: collapse;"> <tr><td>1: 10.1</td><td style="text-align:right;">→</td></tr> <tr><td>2: *10.2</td><td style="text-align:right;">←</td></tr> <tr><td>3: *10.3</td><td style="text-align:right;">←</td></tr> <tr><td>4: *10.3</td><td style="text-align:right;">↑</td></tr> <tr><td>5: *10.8</td><td style="text-align:right;">↑</td></tr> <tr><td>6: *10.5</td><td style="text-align:right;">↗</td></tr> <tr><td>7: *10.2</td><td style="text-align:right;">↖</td></tr> <tr><td>8: *10.3</td><td style="text-align:right;">↗</td></tr> <tr><td>9: 10.1</td><td style="text-align:right;">←</td></tr> <tr><td>10: *10.6</td><td style="text-align:right;">↓</td></tr> <tr><td colspan="2"><hr/></td></tr> <tr><td>Serie</td><td style="text-align:right;">100.0</td></tr> <tr><td>Total</td><td style="text-align:right;">100.0</td></tr> </table>	11: *10.3	↗	12: *10.5	→	13: *10.4	↑	<hr/>		Serie	30.0	Total	0.0	1: 10.1	→	2: *10.2	←	3: *10.3	←	4: *10.3	↑	5: *10.8	↑	6: *10.5	↗	7: *10.2	↖	8: *10.3	↗	9: 10.1	←	10: *10.6	↓	<hr/>		Serie	100.0	Total	100.0														
11: *10.3	↗																																																					
12: *10.5	→																																																					
13: *10.4	↑																																																					
<hr/>																																																						
Serie	30.0																																																					
Total	0.0																																																					
1: 10.1	→																																																					
2: *10.2	←																																																					
3: *10.3	←																																																					
4: *10.3	↑																																																					
5: *10.8	↑																																																					
6: *10.5	↗																																																					
7: *10.2	↖																																																					
8: *10.3	↗																																																					
9: 10.1	←																																																					
10: *10.6	↓																																																					
<hr/>																																																						
Serie	100.0																																																					
Total	100.0																																																					
		<table style="width:100%; border-collapse: collapse;"> <tr><td>14: 10.0</td><td style="text-align:right;">→</td></tr> <tr><td>15: *10.6</td><td style="text-align:right;">↘</td></tr> <tr><td>16: *10.7</td><td style="text-align:right;">↘</td></tr> <tr><td>17: *10.2</td><td style="text-align:right;">↗</td></tr> <tr><td>18: *10.7</td><td style="text-align:right;">↓</td></tr> <tr><td>19: 9.6</td><td style="text-align:right;">←</td></tr> <tr><td>20: 9.4</td><td style="text-align:right;">←</td></tr> <tr><td colspan="2"><hr/></td></tr> <tr><td>Serie</td><td style="text-align:right;">98.0</td></tr> <tr><td>Total</td><td style="text-align:right;">198.0</td></tr> </table> <table style="width:100%; border-collapse: collapse;"> <tr><td>21: 10.0</td><td style="text-align:right;">↖</td></tr> <tr><td>22: *10.3</td><td style="text-align:right;">↘</td></tr> <tr><td>23: *10.4</td><td style="text-align:right;">↑</td></tr> <tr><td>24: *10.6</td><td style="text-align:right;">↘</td></tr> <tr><td>25: *10.2</td><td style="text-align:right;">→</td></tr> <tr><td>26: *10.5</td><td style="text-align:right;">↗</td></tr> <tr><td>27: *10.5</td><td style="text-align:right;">←</td></tr> <tr><td>28: *10.6</td><td style="text-align:right;">↘</td></tr> <tr><td>29: 10.1</td><td style="text-align:right;">↗</td></tr> <tr><td>30: *10.7</td><td style="text-align:right;">↘</td></tr> <tr><td colspan="2"><hr/></td></tr> <tr><td>Serie</td><td style="text-align:right;">100.0</td></tr> <tr><td>Total</td><td style="text-align:right;">298.0</td></tr> </table>	14: 10.0	→	15: *10.6	↘	16: *10.7	↘	17: *10.2	↗	18: *10.7	↓	19: 9.6	←	20: 9.4	←	<hr/>		Serie	98.0	Total	198.0	21: 10.0	↖	22: *10.3	↘	23: *10.4	↑	24: *10.6	↘	25: *10.2	→	26: *10.5	↗	27: *10.5	←	28: *10.6	↘	29: 10.1	↗	30: *10.7	↘	<hr/>		Serie	100.0	Total	298.0						
14: 10.0	→																																																					
15: *10.6	↘																																																					
16: *10.7	↘																																																					
17: *10.2	↗																																																					
18: *10.7	↓																																																					
19: 9.6	←																																																					
20: 9.4	←																																																					
<hr/>																																																						
Serie	98.0																																																					
Total	198.0																																																					
21: 10.0	↖																																																					
22: *10.3	↘																																																					
23: *10.4	↑																																																					
24: *10.6	↘																																																					
25: *10.2	→																																																					
26: *10.5	↗																																																					
27: *10.5	←																																																					
28: *10.6	↘																																																					
29: 10.1	↗																																																					
30: *10.7	↘																																																					
<hr/>																																																						
Serie	100.0																																																					
Total	298.0																																																					
		<table style="width:100%; border-collapse: collapse;"> <tr><td>31: 9.9</td><td style="text-align:right;">↖</td></tr> <tr><td>32: 10.1</td><td style="text-align:right;">→</td></tr> <tr><td>33: 10.1</td><td style="text-align:right;">↗</td></tr> <tr><td>34: 9.9</td><td style="text-align:right;">↗</td></tr> <tr><td>35: 10.1</td><td style="text-align:right;">→</td></tr> <tr><td>36: *10.2</td><td style="text-align:right;">↑</td></tr> <tr><td>37: *10.6</td><td style="text-align:right;">↗</td></tr> <tr><td>38: *10.4</td><td style="text-align:right;">↗</td></tr> <tr><td>39: *10.4</td><td style="text-align:right;">↗</td></tr> <tr><td>40: *10.7</td><td style="text-align:right;">↑</td></tr> <tr><td colspan="2"><hr/></td></tr> <tr><td>Serie</td><td style="text-align:right;">98.0</td></tr> <tr><td>Total</td><td style="text-align:right;">396.0</td></tr> </table> <table style="width:100%; border-collapse: collapse;"> <tr><td>41: 10.0</td><td style="text-align:right;">↘</td></tr> <tr><td>42: 9.9</td><td style="text-align:right;">→</td></tr> <tr><td>43: *10.4</td><td style="text-align:right;">↖</td></tr> <tr><td>44: *10.2</td><td style="text-align:right;">↘</td></tr> <tr><td>45: *10.2</td><td style="text-align:right;">↘</td></tr> <tr><td>46: *10.3</td><td style="text-align:right;">↘</td></tr> <tr><td>47: 10.0</td><td style="text-align:right;">↗</td></tr> <tr><td>48: 9.9</td><td style="text-align:right;">←</td></tr> <tr><td>49: *10.3</td><td style="text-align:right;">↘</td></tr> <tr><td>50: *10.8</td><td style="text-align:right;">↗</td></tr> <tr><td colspan="2"><hr/></td></tr> <tr><td>Serie</td><td style="text-align:right;">98.0</td></tr> <tr><td>Total</td><td style="text-align:right;">494.0</td></tr> </table>	31: 9.9	↖	32: 10.1	→	33: 10.1	↗	34: 9.9	↗	35: 10.1	→	36: *10.2	↑	37: *10.6	↗	38: *10.4	↗	39: *10.4	↗	40: *10.7	↑	<hr/>		Serie	98.0	Total	396.0	41: 10.0	↘	42: 9.9	→	43: *10.4	↖	44: *10.2	↘	45: *10.2	↘	46: *10.3	↘	47: 10.0	↗	48: 9.9	←	49: *10.3	↘	50: *10.8	↗	<hr/>		Serie	98.0	Total	494.0
31: 9.9	↖																																																					
32: 10.1	→																																																					
33: 10.1	↗																																																					
34: 9.9	↗																																																					
35: 10.1	→																																																					
36: *10.2	↑																																																					
37: *10.6	↗																																																					
38: *10.4	↗																																																					
39: *10.4	↗																																																					
40: *10.7	↑																																																					
<hr/>																																																						
Serie	98.0																																																					
Total	396.0																																																					
41: 10.0	↘																																																					
42: 9.9	→																																																					
43: *10.4	↖																																																					
44: *10.2	↘																																																					
45: *10.2	↘																																																					
46: *10.3	↘																																																					
47: 10.0	↗																																																					
48: 9.9	←																																																					
49: *10.3	↘																																																					
50: *10.8	↗																																																					
<hr/>																																																						
Serie	98.0																																																					
Total	494.0																																																					
		<table style="width:100%; border-collapse: collapse;"> <tr><td>51: *10.6</td><td style="text-align:right;">↖</td></tr> <tr><td>52: 8.8</td><td style="text-align:right;">←</td></tr> <tr><td>53: 10.1</td><td style="text-align:right;">→</td></tr> <tr><td>54: *10.3</td><td style="text-align:right;">↗</td></tr> <tr><td>55: *10.6</td><td style="text-align:right;">↑</td></tr> <tr><td>56: *10.2</td><td style="text-align:right;">→</td></tr> <tr><td>57: *10.5</td><td style="text-align:right;">↘</td></tr> <tr><td>58: *10.3</td><td style="text-align:right;">→</td></tr> <tr><td>59: 9.4</td><td style="text-align:right;">↘</td></tr> <tr><td>60: *10.4</td><td style="text-align:right;">←</td></tr> <tr><td colspan="2"><hr/></td></tr> <tr><td>Serie</td><td style="text-align:right;">97.0</td></tr> <tr><td>Total</td><td style="text-align:right;">591.0</td></tr> </table>	51: *10.6	↖	52: 8.8	←	53: 10.1	→	54: *10.3	↗	55: *10.6	↑	56: *10.2	→	57: *10.5	↘	58: *10.3	→	59: 9.4	↘	60: *10.4	←	<hr/>		Serie	97.0	Total	591.0																										
51: *10.6	↖																																																					
52: 8.8	←																																																					
53: 10.1	→																																																					
54: *10.3	↗																																																					
55: *10.6	↑																																																					
56: *10.2	→																																																					
57: *10.5	↘																																																					
58: *10.3	→																																																					
59: 9.4	↘																																																					
60: *10.4	←																																																					
<hr/>																																																						
Serie	97.0																																																					
Total	591.0																																																					

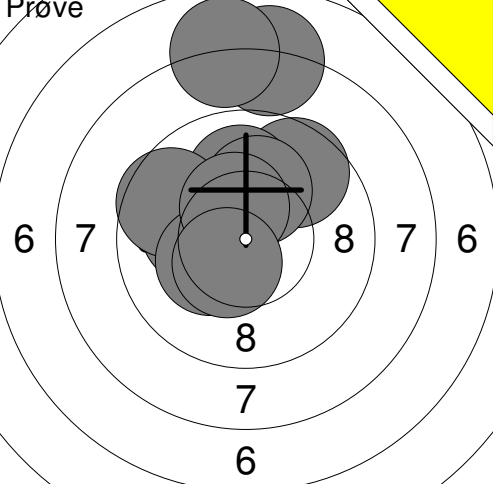
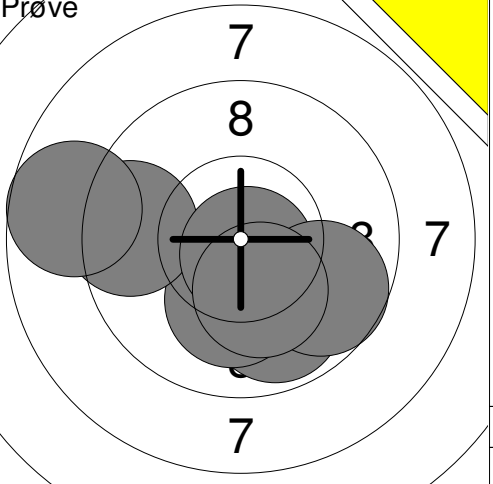
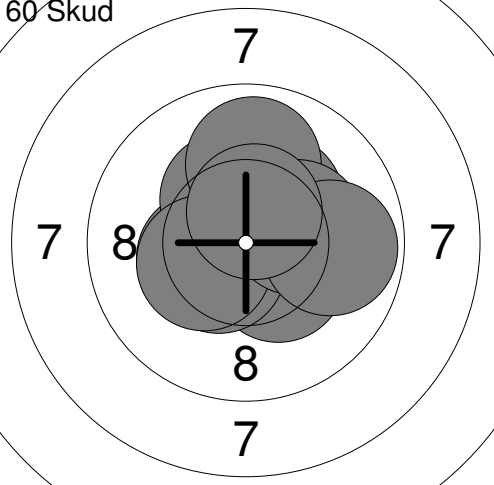
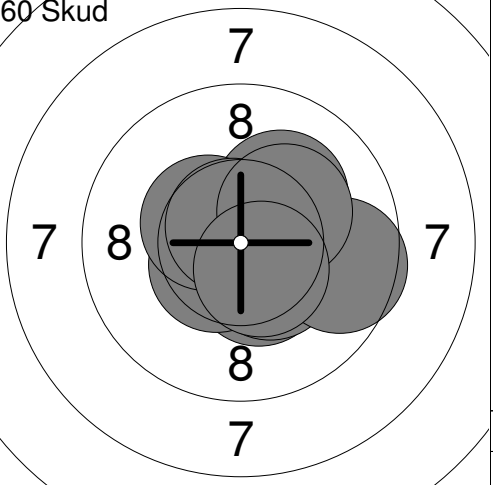
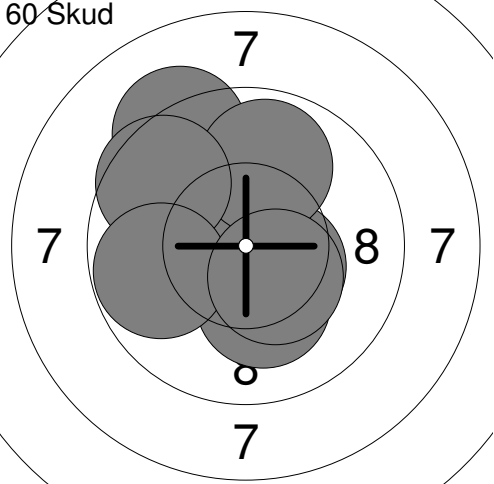
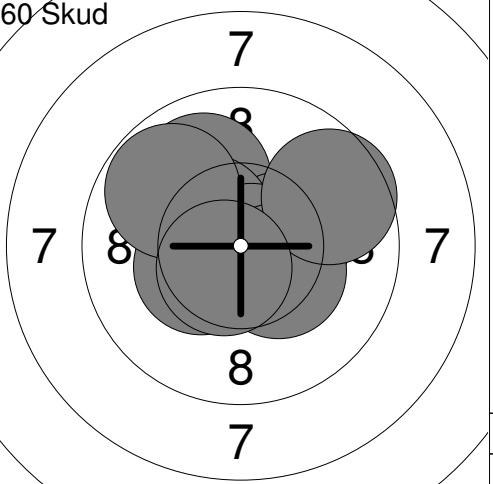
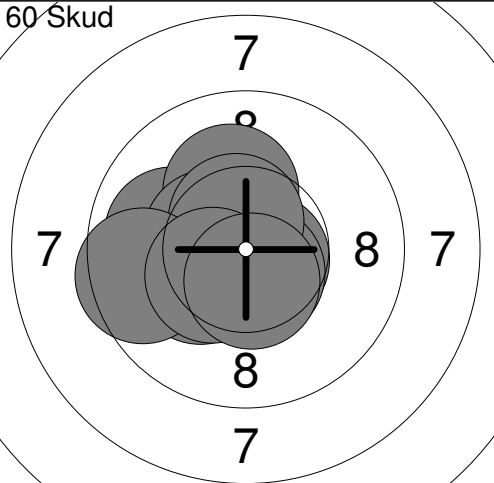
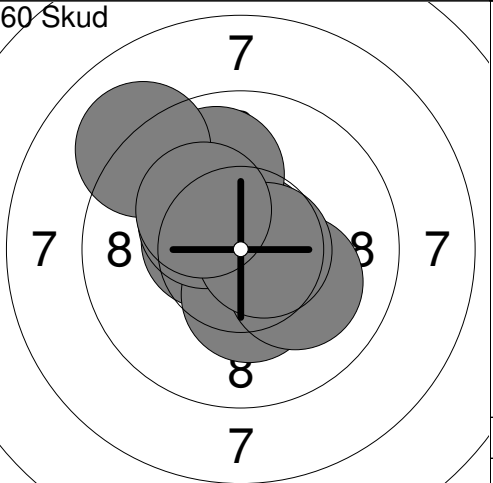
<p>Prøve</p>  <p style="text-align:center;">7 8 7 7</p>	<p>1: 9.7 ↘ 2: 10.1 ← 3: *10.6 ← 4: *10.3 ↘ 5: 9.7 → 6: *10.5 ← 7: 10.1 ↘ 8: 10.1 ↗ 9: 9.3 ← 10: *10.8 ↘</p> <p>Serie 97.0 Total 0.0</p>	<p>Prøve</p>  <p style="text-align:center;">7 8 7 7</p>	<p>11: *10.7 ↗ 12: *10.4 ←</p> <p>Serie 20.0 Total 0.0</p>
<p>60 Skud</p>  <p style="text-align:center;">7 8 7 7</p>	<p>1: *10.4 ↗ 2: *10.4 ↘ 3: *10.2 ↗ 4: *10.3 ↗ 5: 10.0 ↘ 6: *10.4 ↗ 7: *10.4 ← 8: *10.9 ↘ 9: 9.5 ← 10: *10.6 ↘</p> <p>Serie 99.0 Total 99.0</p>	<p>60 Skud</p>  <p style="text-align:center;">7 8 7 7</p>	<p>11: 10.0 ↑ 12: *10.4 ← 13: 10.1 → 14: *10.3 ↗ 15: *10.5 ↗ 16: *10.5 ↗ 17: *10.6 ↘ 18: *10.6 ↗ 19: *10.2 ← 20: *10.2 ↘</p> <p>Serie 100.0 Total 199.0</p>
<p>60 Skud</p>  <p style="text-align:center;">7 8 7 7</p>	<p>21: *10.8 → 22: *10.5 ↘ 23: 10.0 ← 24: *10.4 ↗ 25: *10.3 ↘ 26: 9.9 ↘ 27: *10.3 ↘ 28: 10.1 ↗ 29: *10.2 ↘ 30: *10.3 →</p> <p>Serie 99.0 Total 298.0</p>	<p>60 Skud</p>  <p style="text-align:center;">7 8 7 7</p>	<p>31: 10.0 ← 32: *10.5 ← 33: *10.4 ↗ 34: *10.8 ↗ 35: 10.1 ← 36: *10.5 ← 37: *10.6 ← 38: 9.9 ↑ 39: 10.1 ↗ 40: *10.6 →</p> <p>Serie 99.0 Total 397.0</p>
<p>60 Skud</p>  <p style="text-align:center;">7 8 7 7</p>	<p>41: 9.8 → 42: *10.6 ↘ 43: *10.4 ↑ 44: *10.2 ↘ 45: 9.7 ← 46: *10.6 ← 47: *10.5 ↘ 48: 10.1 ↘ 49: *10.2 ↗ 50: *10.5 ↗</p> <p>Serie 98.0 Total 495.0</p>	<p>60 Skud</p>  <p style="text-align:center;">7 8 7 7</p>	<p>51: *10.3 ↑ 52: *10.4 ↑ 53: 9.9 ↗ 54: *10.5 ↑ 55: *10.7 ↘ 56: *10.5 ← 57: 9.9 ← 58: *10.4 → 59: *10.4 ↗ 60: *10.9 ↗</p> <p>Serie 98.0 Total 593.0</p>

<p>Prøve</p> 	<table border="1" style="width:100%; border-collapse: collapse;"> <tr><td>1:</td><td>8.0</td><td>↑</td></tr> <tr><td>2:</td><td>7.9</td><td>↑</td></tr> <tr><td>3:</td><td>9.6</td><td>↗</td></tr> <tr><td>4:</td><td>10.0</td><td>↑</td></tr> <tr><td>5:</td><td>10.1</td><td>←</td></tr> <tr><td>6:</td><td>9.6</td><td>↖</td></tr> <tr><td>7:</td><td>10.1</td><td>↑</td></tr> <tr><td>8:</td><td>*10.3</td><td>↖</td></tr> <tr><td>9:</td><td>*10.4</td><td>↑</td></tr> <tr><td>10:</td><td>*10.5</td><td>↘</td></tr> <tr><td colspan="2">Serie</td><td>93.0</td></tr> <tr><td colspan="2">Total</td><td>0.0</td></tr> </table>	1:	8.0	↑	2:	7.9	↑	3:	9.6	↗	4:	10.0	↑	5:	10.1	←	6:	9.6	↖	7:	10.1	↑	8:	*10.3	↖	9:	*10.4	↑	10:	*10.5	↘	Serie		93.0	Total		0.0	<p>Prøve</p>  <table border="1" style="width:100%; border-collapse: collapse;"> <tr><td>11:</td><td>9.9</td><td>↘</td></tr> <tr><td>12:</td><td>10.1</td><td>↘</td></tr> <tr><td>13:</td><td>9.5</td><td>←</td></tr> <tr><td>14:</td><td>*10.7</td><td>↘</td></tr> <tr><td>15:</td><td>9.7</td><td>↘</td></tr> <tr><td>16:</td><td>8.7</td><td>←</td></tr> <tr><td>17:</td><td>*10.2</td><td>↘</td></tr> <tr><td colspan="2">Serie</td><td>65.0</td></tr> <tr><td colspan="2">Total</td><td>0.0</td></tr> </table>	11:	9.9	↘	12:	10.1	↘	13:	9.5	←	14:	*10.7	↘	15:	9.7	↘	16:	8.7	←	17:	*10.2	↘	Serie		65.0	Total		0.0									
1:	8.0	↑																																																																								
2:	7.9	↑																																																																								
3:	9.6	↗																																																																								
4:	10.0	↑																																																																								
5:	10.1	←																																																																								
6:	9.6	↖																																																																								
7:	10.1	↑																																																																								
8:	*10.3	↖																																																																								
9:	*10.4	↑																																																																								
10:	*10.5	↘																																																																								
Serie		93.0																																																																								
Total		0.0																																																																								
11:	9.9	↘																																																																								
12:	10.1	↘																																																																								
13:	9.5	←																																																																								
14:	*10.7	↘																																																																								
15:	9.7	↘																																																																								
16:	8.7	←																																																																								
17:	*10.2	↘																																																																								
Serie		65.0																																																																								
Total		0.0																																																																								
<p>60 Skud</p> 	<table border="1" style="width:100%; border-collapse: collapse;"> <tr><td>1:</td><td>*10.4</td><td>←</td></tr> <tr><td>2:</td><td>*10.4</td><td>↘</td></tr> <tr><td>3:</td><td>*10.3</td><td>↗</td></tr> <tr><td>4:</td><td>*10.3</td><td>↗</td></tr> <tr><td>5:</td><td>9.9</td><td>↑</td></tr> <tr><td>6:</td><td>*10.5</td><td>↖</td></tr> <tr><td>7:</td><td>*10.3</td><td>↖</td></tr> <tr><td>8:</td><td>*10.3</td><td>→</td></tr> <tr><td>9:</td><td>9.8</td><td>→</td></tr> <tr><td>10:</td><td>*10.5</td><td>↑</td></tr> <tr><td colspan="2">Serie</td><td>98.0</td></tr> <tr><td colspan="2">Total</td><td>98.0</td></tr> </table>	1:	*10.4	←	2:	*10.4	↘	3:	*10.3	↗	4:	*10.3	↗	5:	9.9	↑	6:	*10.5	↖	7:	*10.3	↖	8:	*10.3	→	9:	9.8	→	10:	*10.5	↑	Serie		98.0	Total		98.0	<p>60 Skud</p>  <table border="1" style="width:100%; border-collapse: collapse;"> <tr><td>11:</td><td>*10.4</td><td>↘</td></tr> <tr><td>12:</td><td>*10.4</td><td>↗</td></tr> <tr><td>13:</td><td>*10.5</td><td>↖</td></tr> <tr><td>14:</td><td>*10.4</td><td>↘</td></tr> <tr><td>15:</td><td>*10.2</td><td>↗</td></tr> <tr><td>16:</td><td>*10.4</td><td>↗</td></tr> <tr><td>17:</td><td>*10.7</td><td>↗</td></tr> <tr><td>18:</td><td>9.6</td><td>→</td></tr> <tr><td>19:</td><td>*10.2</td><td>↗</td></tr> <tr><td>20:</td><td>*10.5</td><td>↘</td></tr> <tr><td colspan="2">Serie</td><td>99.0</td></tr> <tr><td colspan="2">Total</td><td>197.0</td></tr> </table>	11:	*10.4	↘	12:	*10.4	↗	13:	*10.5	↖	14:	*10.4	↘	15:	*10.2	↗	16:	*10.4	↗	17:	*10.7	↗	18:	9.6	→	19:	*10.2	↗	20:	*10.5	↘	Serie		99.0	Total		197.0
1:	*10.4	←																																																																								
2:	*10.4	↘																																																																								
3:	*10.3	↗																																																																								
4:	*10.3	↗																																																																								
5:	9.9	↑																																																																								
6:	*10.5	↖																																																																								
7:	*10.3	↖																																																																								
8:	*10.3	→																																																																								
9:	9.8	→																																																																								
10:	*10.5	↑																																																																								
Serie		98.0																																																																								
Total		98.0																																																																								
11:	*10.4	↘																																																																								
12:	*10.4	↗																																																																								
13:	*10.5	↖																																																																								
14:	*10.4	↘																																																																								
15:	*10.2	↗																																																																								
16:	*10.4	↗																																																																								
17:	*10.7	↗																																																																								
18:	9.6	→																																																																								
19:	*10.2	↗																																																																								
20:	*10.5	↘																																																																								
Serie		99.0																																																																								
Total		197.0																																																																								
<p>60 Skud</p> 	<table border="1" style="width:100%; border-collapse: collapse;"> <tr><td>21:</td><td>10.0</td><td>↗</td></tr> <tr><td>22:</td><td>*10.2</td><td>↘</td></tr> <tr><td>23:</td><td>9.2</td><td>↗</td></tr> <tr><td>24:</td><td>*10.4</td><td>↘</td></tr> <tr><td>25:</td><td>10.0</td><td>←</td></tr> <tr><td>26:</td><td>*10.9</td><td>→</td></tr> <tr><td>27:</td><td>9.9</td><td>↑</td></tr> <tr><td>28:</td><td>9.6</td><td>↗</td></tr> <tr><td>29:</td><td>9.8</td><td>←</td></tr> <tr><td>30:</td><td>*10.4</td><td>↘</td></tr> <tr><td colspan="2">Serie</td><td>96.0</td></tr> <tr><td colspan="2">Total</td><td>293.0</td></tr> </table>	21:	10.0	↗	22:	*10.2	↘	23:	9.2	↗	24:	*10.4	↘	25:	10.0	←	26:	*10.9	→	27:	9.9	↑	28:	9.6	↗	29:	9.8	←	30:	*10.4	↘	Serie		96.0	Total		293.0	<p>60 Skud</p>  <table border="1" style="width:100%; border-collapse: collapse;"> <tr><td>31:</td><td>10.0</td><td>↗</td></tr> <tr><td>32:</td><td>*10.4</td><td>→</td></tr> <tr><td>33:</td><td>*10.6</td><td>↘</td></tr> <tr><td>34:</td><td>*10.4</td><td>↗</td></tr> <tr><td>35:</td><td>*10.8</td><td>↘</td></tr> <tr><td>36:</td><td>*10.4</td><td>↖</td></tr> <tr><td>37:</td><td>9.8</td><td>↗</td></tr> <tr><td>38:</td><td>*10.3</td><td>↘</td></tr> <tr><td>39:</td><td>9.6</td><td>↗</td></tr> <tr><td>40:</td><td>*10.6</td><td>↘</td></tr> <tr><td colspan="2">Serie</td><td>98.0</td></tr> <tr><td colspan="2">Total</td><td>391.0</td></tr> </table>	31:	10.0	↗	32:	*10.4	→	33:	*10.6	↘	34:	*10.4	↗	35:	*10.8	↘	36:	*10.4	↖	37:	9.8	↗	38:	*10.3	↘	39:	9.6	↗	40:	*10.6	↘	Serie		98.0	Total		391.0
21:	10.0	↗																																																																								
22:	*10.2	↘																																																																								
23:	9.2	↗																																																																								
24:	*10.4	↘																																																																								
25:	10.0	←																																																																								
26:	*10.9	→																																																																								
27:	9.9	↑																																																																								
28:	9.6	↗																																																																								
29:	9.8	←																																																																								
30:	*10.4	↘																																																																								
Serie		96.0																																																																								
Total		293.0																																																																								
31:	10.0	↗																																																																								
32:	*10.4	→																																																																								
33:	*10.6	↘																																																																								
34:	*10.4	↗																																																																								
35:	*10.8	↘																																																																								
36:	*10.4	↖																																																																								
37:	9.8	↗																																																																								
38:	*10.3	↘																																																																								
39:	9.6	↗																																																																								
40:	*10.6	↘																																																																								
Serie		98.0																																																																								
Total		391.0																																																																								
<p>60 Skud</p> 	<table border="1" style="width:100%; border-collapse: collapse;"> <tr><td>41:</td><td>10.0</td><td>←</td></tr> <tr><td>42:</td><td>*10.7</td><td>↘</td></tr> <tr><td>43:</td><td>*10.6</td><td>↘</td></tr> <tr><td>44:</td><td>*10.3</td><td>↖</td></tr> <tr><td>45:</td><td>*10.2</td><td>↑</td></tr> <tr><td>46:</td><td>*10.5</td><td>↖</td></tr> <tr><td>47:</td><td>*10.6</td><td>↗</td></tr> <tr><td>48:</td><td>9.5</td><td>←</td></tr> <tr><td>49:</td><td>*10.4</td><td>↖</td></tr> <tr><td>50:</td><td>*10.5</td><td>↘</td></tr> <tr><td colspan="2">Serie</td><td>99.0</td></tr> <tr><td colspan="2">Total</td><td>490.0</td></tr> </table>	41:	10.0	←	42:	*10.7	↘	43:	*10.6	↘	44:	*10.3	↖	45:	*10.2	↑	46:	*10.5	↖	47:	*10.6	↗	48:	9.5	←	49:	*10.4	↖	50:	*10.5	↘	Serie		99.0	Total		490.0	<p>60 Skud</p>  <table border="1" style="width:100%; border-collapse: collapse;"> <tr><td>51:</td><td>*10.8</td><td>↗</td></tr> <tr><td>52:</td><td>9.9</td><td>↑</td></tr> <tr><td>53:</td><td>9.1</td><td>↗</td></tr> <tr><td>54:</td><td>*10.5</td><td>←</td></tr> <tr><td>55:</td><td>*10.5</td><td>↘</td></tr> <tr><td>56:</td><td>*10.3</td><td>↘</td></tr> <tr><td>57:</td><td>10.1</td><td>↘</td></tr> <tr><td>58:</td><td>*10.4</td><td>↗</td></tr> <tr><td>59:</td><td>*10.6</td><td>→</td></tr> <tr><td>60:</td><td>*10.2</td><td>↗</td></tr> <tr><td colspan="2">Serie</td><td>98.0</td></tr> <tr><td colspan="2">Total</td><td>588.0</td></tr> </table>	51:	*10.8	↗	52:	9.9	↑	53:	9.1	↗	54:	*10.5	←	55:	*10.5	↘	56:	*10.3	↘	57:	10.1	↘	58:	*10.4	↗	59:	*10.6	→	60:	*10.2	↗	Serie		98.0	Total		588.0
41:	10.0	←																																																																								
42:	*10.7	↘																																																																								
43:	*10.6	↘																																																																								
44:	*10.3	↖																																																																								
45:	*10.2	↑																																																																								
46:	*10.5	↖																																																																								
47:	*10.6	↗																																																																								
48:	9.5	←																																																																								
49:	*10.4	↖																																																																								
50:	*10.5	↘																																																																								
Serie		99.0																																																																								
Total		490.0																																																																								
51:	*10.8	↗																																																																								
52:	9.9	↑																																																																								
53:	9.1	↗																																																																								
54:	*10.5	←																																																																								
55:	*10.5	↘																																																																								
56:	*10.3	↘																																																																								
57:	10.1	↘																																																																								
58:	*10.4	↗																																																																								
59:	*10.6	→																																																																								
60:	*10.2	↗																																																																								
Serie		98.0																																																																								
Total		588.0																																																																								

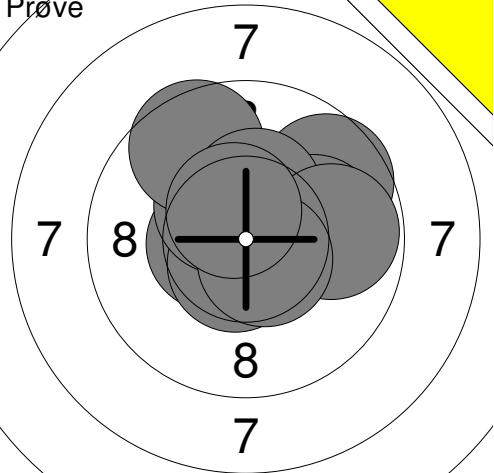
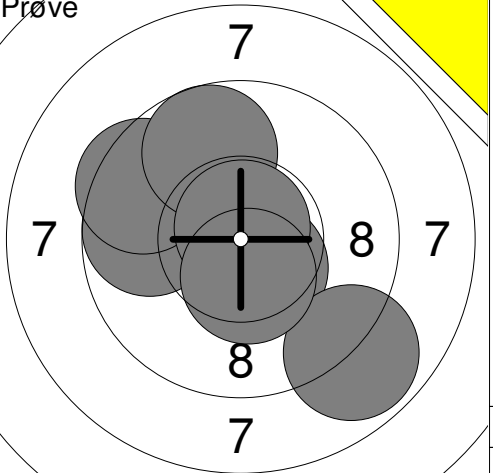
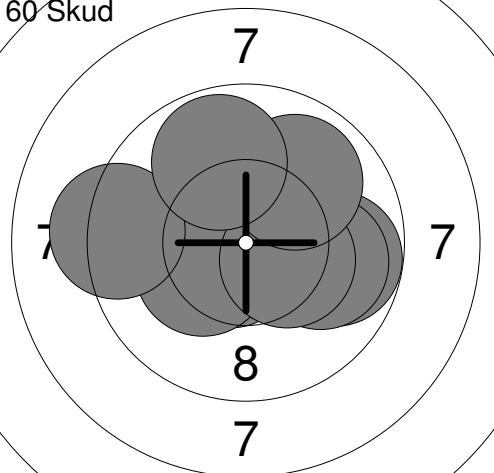
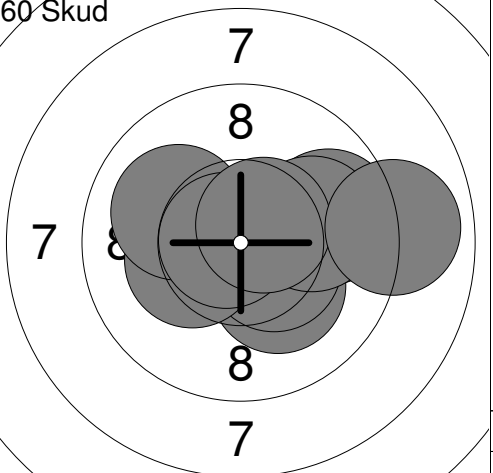
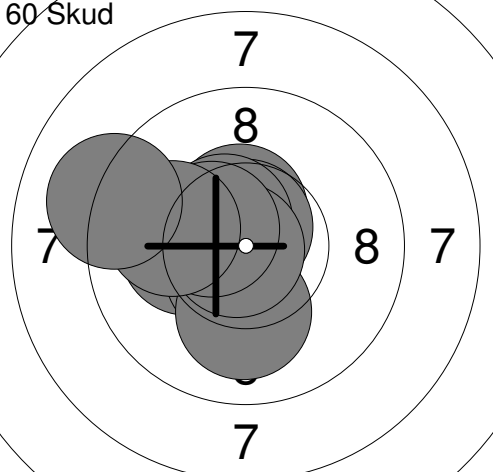
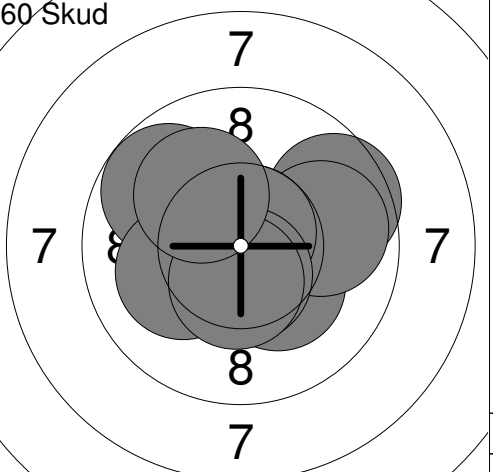
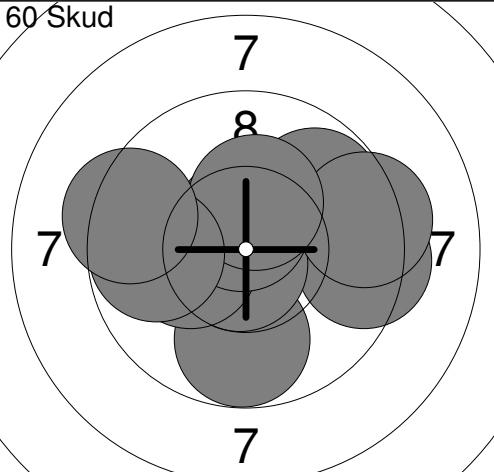
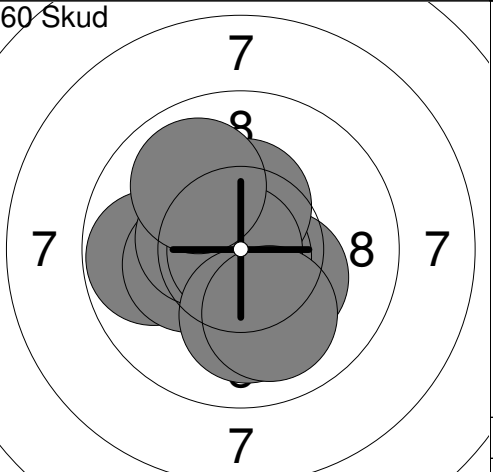
Hold	Skive	Rasmus Ørtoft			
2	10	Særslev Skytteforening		H	R
10m		DIF 4. runde		Aalborg Skyttekreds	
19.01.2013					
Prøve 	1: 9.4 →	Prøve 	11: 9.8 ←	11: 9.8 ← 12: *10.4 ← 13: 9.8 ← 14: *10.7 ← 15: 10.1 ↑ 16: 9.6 ↗ 17: 9.4 ↗ 18: 10.1 ↓ 19: *10.2 ← 20: *10.4 ↗	
	2: 10.0 ↗		12: *10.4 ←		
	3: *10.5 →		13: 9.8 ←		
	4: *10.4 →		14: *10.7 ←		
	5: 9.9 ↗		15: 10.1 ↑		
	6: 9.5 ←		16: 9.6 ↗		
	7: 9.5 →		17: 9.4 ↗		
	8: 9.5 →		18: 10.1 ↓		
	9: *10.3 ↗		19: *10.2 ←		
	10: 9.8 →		20: *10.4 ↗		
	Serie 85.0		Serie 96.0		
	Total 0.0		Total 0.0		
Prøve 	21: *10.2 ←	60 Skud 	1: 10.1 ↗	1: 10.1 ↗ 2: *10.4 ↑ 3: *10.8 ↓ 4: 10.0 → 5: *10.3 ← 6: *10.3 ↗ 7: 9.8 ↗ 8: *10.5 ↗ 9: 9.9 ↘ 10: *10.3 ↗	
			2: *10.4 ↑		
			3: *10.8 ↓		
		4: 10.0 →	4: 10.0 →		
		5: *10.3 ←	5: *10.3 ←		
		6: *10.3 ↗	6: *10.3 ↗		
		7: 9.8 ↗	7: 9.8 ↗		
		8: *10.5 ↗	8: *10.5 ↗		
		9: 9.9 ↘	9: 9.9 ↘		
		10: *10.3 ↗	10: *10.3 ↗		
	Serie 10.0		Serie 98.0		
	Total 0.0		Total 98.0		
60 Skud 	11: *10.4 ↗	60 Skud 	21: 10.1 ↓	21: 10.1 ↓ 22: *10.5 ↗ 23: *10.7 ← 24: 10.0 → 25: 9.9 → 26: *10.3 ↗ 27: *10.7 ↓ 28: *10.3 → 29: *10.2 ↓ 30: *10.4 →	
	12: *10.2 ↗		22: *10.5 ↗		
	13: 9.7 ↗		23: *10.7 ←		
	14: 9.8 →		24: 10.0 →		
	15: 10.1 ↗		25: 9.9 →		
	16: *10.5 ←		26: *10.3 ↗		
	17: 9.8 ←		27: *10.7 ↓		
	18: *10.2 ↗		28: *10.3 →		
	19: *10.5 ↓		29: *10.2 ↓		
	20: 9.7 ←		30: *10.4 →		
	Serie 96.0		Serie 99.0		
	Total 194.0		Total 293.0		
60 Skud 	31: 10.0 ↑	60 Skud 	41: 10.1 ↓	41: 10.1 ↓ 42: 9.8 ↗ 43: 9.7 ↓ 44: 9.4 ← 45: 10.1 ↓ 46: *10.6 ← 47: *10.8 ↓ 48: 9.8 → 49: *10.4 ↑ 50: 10.1 ↗	
	32: *10.4 ←		42: 9.8 ↗		
	33: *10.6 →		43: 9.7 ↓		
	34: 9.9 ↗		44: 9.4 ←		
	35: *10.6 ↗		45: 10.1 ↓		
	36: *10.4 ↗		46: *10.6 ←		
	37: 10.1 ↓		47: *10.8 ↓		
	38: 10.0 ↓		48: 9.8 →		
	39: *10.3 ←		49: *10.4 ↑		
	40: *10.3 ↓		50: 10.1 ↗		
	Serie 99.0		Serie 96.0		
	Total 392.0		Total 488.0		
60 Skud 	51: 10.0 ↗				
	52: 10.1 ↗				
	53: *10.3 ↗				
	54: *10.6 ↗				
	55: 10.1 →				
	56: *10.7 →				
	57: 10.0 →				
	58: 9.8 ←				
	59: *10.5 ↓				
	60: *10.6 ↓				
	Serie 99.0				
	Total 587.0				

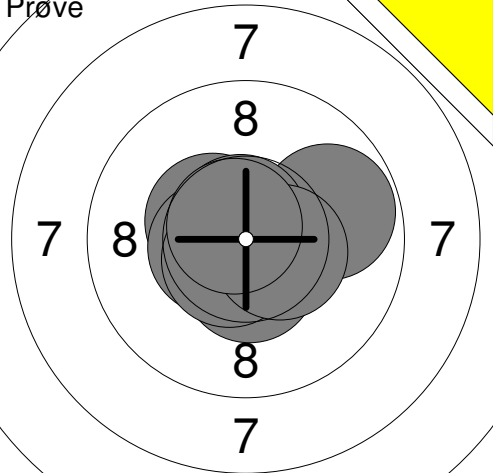
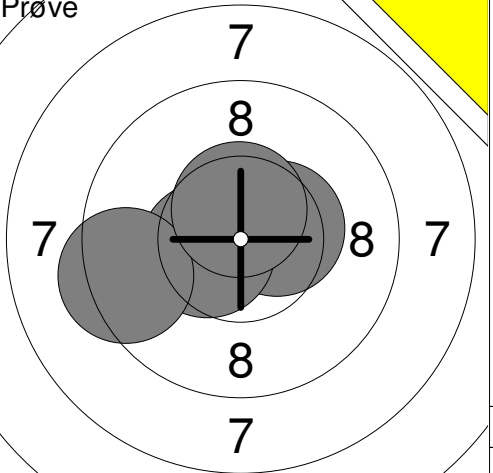
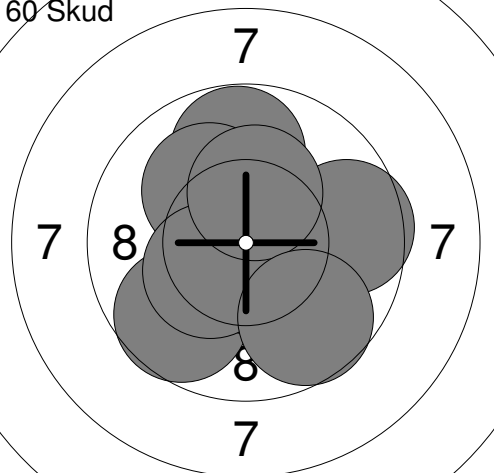
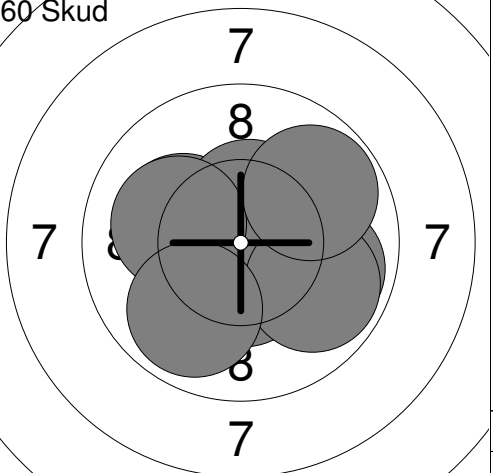
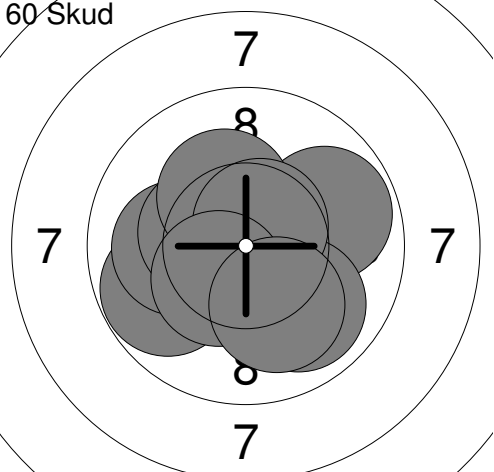
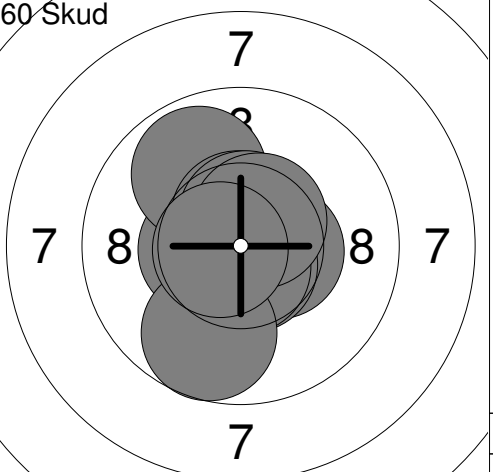
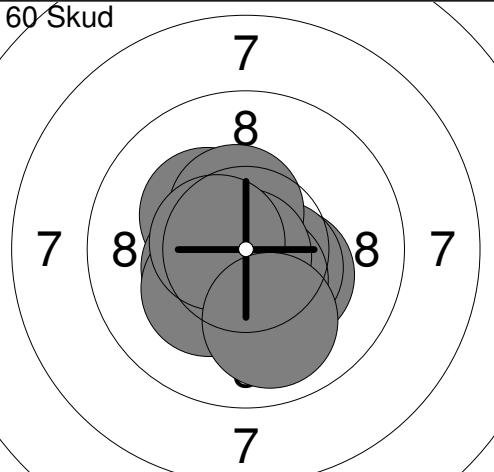
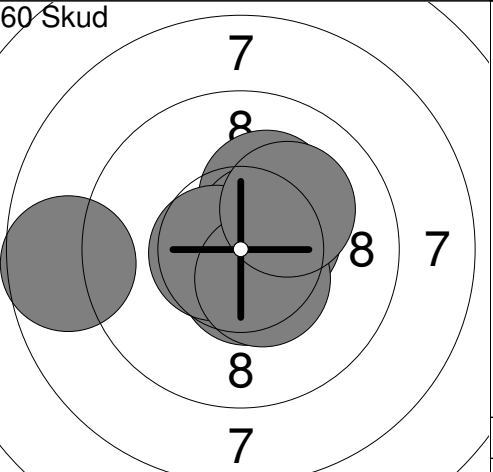
<b>Prøve</b> 	<table border="1" style="width:100%; border-collapse: collapse;"> <tr><td>1:</td><td>9.6</td><td>↗</td></tr> <tr><td>2:</td><td>*10.5</td><td>←</td></tr> <tr><td>3:</td><td>*10.6</td><td>↘</td></tr> <tr><td>4:</td><td>*10.4</td><td>↗</td></tr> <tr><td>5:</td><td>10.0</td><td>→</td></tr> <tr><td>6:</td><td>9.6</td><td>↗</td></tr> <tr><td>7:</td><td>*10.4</td><td>↑</td></tr> <tr><td>8:</td><td>9.8</td><td>→</td></tr> <tr><td>9:</td><td>*10.6</td><td>↘</td></tr> <tr><td>10:</td><td>*10.5</td><td>↗</td></tr> <tr><td colspan="2"><b>Serie</b></td><td>97.0</td></tr> <tr><td colspan="2"><b>Total</b></td><td>0.0</td></tr> </table>	1:	9.6	↗	2:	*10.5	←	3:	*10.6	↘	4:	*10.4	↗	5:	10.0	→	6:	9.6	↗	7:	*10.4	↑	8:	9.8	→	9:	*10.6	↘	10:	*10.5	↗	<b>Serie</b>		97.0	<b>Total</b>		0.0	<b>Prøve</b> 	<table border="1" style="width:100%; border-collapse: collapse;"> <tr><td>11:</td><td>9.7</td><td>←</td></tr> <tr><td>12:</td><td>9.5</td><td>↗</td></tr> <tr><td>13:</td><td>*10.5</td><td>↘</td></tr> <tr><td>14:</td><td>9.7</td><td>↗</td></tr> <tr><td>15:</td><td>*10.8</td><td>↑</td></tr> <tr><td>16:</td><td>8.9</td><td>↘</td></tr> <tr><td>17:</td><td>*10.4</td><td>↘</td></tr> <tr><td colspan="2"><b>Serie</b></td><td>65.0</td></tr> <tr><td colspan="2"><b>Total</b></td><td>0.0</td></tr> </table>	11:	9.7	←	12:	9.5	↗	13:	*10.5	↘	14:	9.7	↗	15:	*10.8	↑	16:	8.9	↘	17:	*10.4	↘	<b>Serie</b>		65.0	<b>Total</b>		0.0									
1:	9.6	↗																																																																									
2:	*10.5	←																																																																									
3:	*10.6	↘																																																																									
4:	*10.4	↗																																																																									
5:	10.0	→																																																																									
6:	9.6	↗																																																																									
7:	*10.4	↑																																																																									
8:	9.8	→																																																																									
9:	*10.6	↘																																																																									
10:	*10.5	↗																																																																									
<b>Serie</b>		97.0																																																																									
<b>Total</b>		0.0																																																																									
11:	9.7	←																																																																									
12:	9.5	↗																																																																									
13:	*10.5	↘																																																																									
14:	9.7	↗																																																																									
15:	*10.8	↑																																																																									
16:	8.9	↘																																																																									
17:	*10.4	↘																																																																									
<b>Serie</b>		65.0																																																																									
<b>Total</b>		0.0																																																																									
<b>60 Skud</b> 	<table border="1" style="width:100%; border-collapse: collapse;"> <tr><td>1:</td><td>9.8</td><td>→</td></tr> <tr><td>2:</td><td>*10.6</td><td>↘</td></tr> <tr><td>3:</td><td>9.9</td><td>→</td></tr> <tr><td>4:</td><td>*10.6</td><td>↘</td></tr> <tr><td>5:</td><td>*10.5</td><td>↑</td></tr> <tr><td>6:</td><td>*10.3</td><td>←</td></tr> <tr><td>7:</td><td>9.2</td><td>←</td></tr> <tr><td>8:</td><td>*10.4</td><td>↘</td></tr> <tr><td>9:</td><td>9.9</td><td>↗</td></tr> <tr><td>10:</td><td>9.8</td><td>↗</td></tr> <tr><td colspan="2"><b>Serie</b></td><td>95.0</td></tr> <tr><td colspan="2"><b>Total</b></td><td>95.0</td></tr> </table>	1:	9.8	→	2:	*10.6	↘	3:	9.9	→	4:	*10.6	↘	5:	*10.5	↑	6:	*10.3	←	7:	9.2	←	8:	*10.4	↘	9:	9.9	↗	10:	9.8	↗	<b>Serie</b>		95.0	<b>Total</b>		95.0	<b>60 Skud</b> 	<table border="1" style="width:100%; border-collapse: collapse;"> <tr><td>11:</td><td>*10.7</td><td>←</td></tr> <tr><td>12:</td><td>*10.2</td><td>↘</td></tr> <tr><td>13:</td><td>*10.4</td><td>↘</td></tr> <tr><td>14:</td><td>*10.3</td><td>←</td></tr> <tr><td>15:</td><td>10.0</td><td>↗</td></tr> <tr><td>16:</td><td>9.7</td><td>→</td></tr> <tr><td>17:</td><td>*10.8</td><td>←</td></tr> <tr><td>18:</td><td>10.0</td><td>→</td></tr> <tr><td>19:</td><td>*10.6</td><td>↗</td></tr> <tr><td>20:</td><td>8.9</td><td>→</td></tr> <tr><td colspan="2"><b>Serie</b></td><td>97.0</td></tr> <tr><td colspan="2"><b>Total</b></td><td>192.0</td></tr> </table>	11:	*10.7	←	12:	*10.2	↘	13:	*10.4	↘	14:	*10.3	←	15:	10.0	↗	16:	9.7	→	17:	*10.8	←	18:	10.0	→	19:	*10.6	↗	20:	8.9	→	<b>Serie</b>		97.0	<b>Total</b>		192.0
1:	9.8	→																																																																									
2:	*10.6	↘																																																																									
3:	9.9	→																																																																									
4:	*10.6	↘																																																																									
5:	*10.5	↑																																																																									
6:	*10.3	←																																																																									
7:	9.2	←																																																																									
8:	*10.4	↘																																																																									
9:	9.9	↗																																																																									
10:	9.8	↗																																																																									
<b>Serie</b>		95.0																																																																									
<b>Total</b>		95.0																																																																									
11:	*10.7	←																																																																									
12:	*10.2	↘																																																																									
13:	*10.4	↘																																																																									
14:	*10.3	←																																																																									
15:	10.0	↗																																																																									
16:	9.7	→																																																																									
17:	*10.8	←																																																																									
18:	10.0	→																																																																									
19:	*10.6	↗																																																																									
20:	8.9	→																																																																									
<b>Serie</b>		97.0																																																																									
<b>Total</b>		192.0																																																																									
<b>60 Skud</b> 	<table border="1" style="width:100%; border-collapse: collapse;"> <tr><td>21:</td><td>*10.5</td><td>↑</td></tr> <tr><td>22:</td><td>*10.7</td><td>↑</td></tr> <tr><td>23:</td><td>*10.2</td><td>←</td></tr> <tr><td>24:</td><td>*10.5</td><td>↗</td></tr> <tr><td>25:</td><td>*10.6</td><td>↘</td></tr> <tr><td>26:</td><td>10.1</td><td>↘</td></tr> <tr><td>27:</td><td>*10.8</td><td>←</td></tr> <tr><td>28:</td><td>*10.5</td><td>↗</td></tr> <tr><td>29:</td><td>10.0</td><td>←</td></tr> <tr><td>30:</td><td>9.1</td><td>←</td></tr> <tr><td colspan="2"><b>Serie</b></td><td>99.0</td></tr> <tr><td colspan="2"><b>Total</b></td><td>291.0</td></tr> </table>	21:	*10.5	↑	22:	*10.7	↑	23:	*10.2	←	24:	*10.5	↗	25:	*10.6	↘	26:	10.1	↘	27:	*10.8	←	28:	*10.5	↗	29:	10.0	←	30:	9.1	←	<b>Serie</b>		99.0	<b>Total</b>		291.0	<b>60 Skud</b> 	<table border="1" style="width:100%; border-collapse: collapse;"> <tr><td>31:</td><td>*10.3</td><td>↘</td></tr> <tr><td>32:</td><td>*10.8</td><td>↘</td></tr> <tr><td>33:</td><td>9.8</td><td>↗</td></tr> <tr><td>34:</td><td>9.6</td><td>↗</td></tr> <tr><td>35:</td><td>10.1</td><td>←</td></tr> <tr><td>36:</td><td>9.9</td><td>→</td></tr> <tr><td>37:</td><td>*10.7</td><td>↗</td></tr> <tr><td>38:</td><td>*10.6</td><td>↘</td></tr> <tr><td>39:</td><td>*10.5</td><td>↘</td></tr> <tr><td>40:</td><td>10.1</td><td>↗</td></tr> <tr><td colspan="2"><b>Serie</b></td><td>97.0</td></tr> <tr><td colspan="2"><b>Total</b></td><td>388.0</td></tr> </table>	31:	*10.3	↘	32:	*10.8	↘	33:	9.8	↗	34:	9.6	↗	35:	10.1	←	36:	9.9	→	37:	*10.7	↗	38:	*10.6	↘	39:	*10.5	↘	40:	10.1	↗	<b>Serie</b>		97.0	<b>Total</b>		388.0
21:	*10.5	↑																																																																									
22:	*10.7	↑																																																																									
23:	*10.2	←																																																																									
24:	*10.5	↗																																																																									
25:	*10.6	↘																																																																									
26:	10.1	↘																																																																									
27:	*10.8	←																																																																									
28:	*10.5	↗																																																																									
29:	10.0	←																																																																									
30:	9.1	←																																																																									
<b>Serie</b>		99.0																																																																									
<b>Total</b>		291.0																																																																									
31:	*10.3	↘																																																																									
32:	*10.8	↘																																																																									
33:	9.8	↗																																																																									
34:	9.6	↗																																																																									
35:	10.1	←																																																																									
36:	9.9	→																																																																									
37:	*10.7	↗																																																																									
38:	*10.6	↘																																																																									
39:	*10.5	↘																																																																									
40:	10.1	↗																																																																									
<b>Serie</b>		97.0																																																																									
<b>Total</b>		388.0																																																																									
<b>60 Skud</b> 	<table border="1" style="width:100%; border-collapse: collapse;"> <tr><td>41:</td><td>9.8</td><td>↗</td></tr> <tr><td>42:</td><td>9.4</td><td>→</td></tr> <tr><td>43:</td><td>9.8</td><td>↘</td></tr> <tr><td>44:</td><td>*10.7</td><td>↘</td></tr> <tr><td>45:</td><td>*10.2</td><td>←</td></tr> <tr><td>46:</td><td>9.3</td><td>→</td></tr> <tr><td>47:</td><td>*10.6</td><td>↑</td></tr> <tr><td>48:</td><td>*10.3</td><td>↑</td></tr> <tr><td>49:</td><td>9.8</td><td>←</td></tr> <tr><td>50:</td><td>9.4</td><td>←</td></tr> <tr><td colspan="2"><b>Serie</b></td><td>94.0</td></tr> <tr><td colspan="2"><b>Total</b></td><td>482.0</td></tr> </table>	41:	9.8	↗	42:	9.4	→	43:	9.8	↘	44:	*10.7	↘	45:	*10.2	←	46:	9.3	→	47:	*10.6	↑	48:	*10.3	↑	49:	9.8	←	50:	9.4	←	<b>Serie</b>		94.0	<b>Total</b>		482.0	<b>60 Skud</b> 	<table border="1" style="width:100%; border-collapse: collapse;"> <tr><td>51:</td><td>*10.3</td><td>↘</td></tr> <tr><td>52:</td><td>*10.8</td><td>↘</td></tr> <tr><td>53:</td><td>9.8</td><td>←</td></tr> <tr><td>54:</td><td>*10.3</td><td>←</td></tr> <tr><td>55:</td><td>*10.4</td><td>←</td></tr> <tr><td>56:</td><td>*10.4</td><td>↑</td></tr> <tr><td>57:</td><td>*10.9</td><td>←</td></tr> <tr><td>58:</td><td>10.1</td><td>↘</td></tr> <tr><td>59:</td><td>10.0</td><td>↘</td></tr> <tr><td>60:</td><td>9.9</td><td>↗</td></tr> <tr><td colspan="2"><b>Serie</b></td><td>98.0</td></tr> <tr><td colspan="2"><b>Total</b></td><td>580.0</td></tr> </table>	51:	*10.3	↘	52:	*10.8	↘	53:	9.8	←	54:	*10.3	←	55:	*10.4	←	56:	*10.4	↑	57:	*10.9	←	58:	10.1	↘	59:	10.0	↘	60:	9.9	↗	<b>Serie</b>		98.0	<b>Total</b>		580.0
41:	9.8	↗																																																																									
42:	9.4	→																																																																									
43:	9.8	↘																																																																									
44:	*10.7	↘																																																																									
45:	*10.2	←																																																																									
46:	9.3	→																																																																									
47:	*10.6	↑																																																																									
48:	*10.3	↑																																																																									
49:	9.8	←																																																																									
50:	9.4	←																																																																									
<b>Serie</b>		94.0																																																																									
<b>Total</b>		482.0																																																																									
51:	*10.3	↘																																																																									
52:	*10.8	↘																																																																									
53:	9.8	←																																																																									
54:	*10.3	←																																																																									
55:	*10.4	←																																																																									
56:	*10.4	↑																																																																									
57:	*10.9	←																																																																									
58:	10.1	↘																																																																									
59:	10.0	↘																																																																									
60:	9.9	↗																																																																									
<b>Serie</b>		98.0																																																																									
<b>Total</b>		580.0																																																																									

Prøve	Prøve																											
		<table style="width:100%; border-collapse: collapse;"> <tr><td>1: *10.7</td><td style="text-align:right;">←</td></tr> <tr><td>2: 9.8</td><td style="text-align:right;">→</td></tr> <tr><td>3: *10.6</td><td style="text-align:right;">↓</td></tr> <tr><td>4: *10.4</td><td style="text-align:right;">↗</td></tr> <tr><td>5: *10.5</td><td style="text-align:right;">↓</td></tr> <tr><td>6: *10.5</td><td style="text-align:right;">←</td></tr> <tr><td>7: *10.7</td><td style="text-align:right;">↑</td></tr> <tr><td>8: *10.6</td><td style="text-align:right;">↙</td></tr> <tr><td>9: *10.5</td><td style="text-align:right;">→</td></tr> <tr><td>10: *10.7</td><td style="text-align:right;">↗</td></tr> <tr><td colspan="2"><hr/></td></tr> <tr><td>Serie</td><td style="text-align:right;">99.0</td></tr> <tr><td>Total</td><td style="text-align:right;">0.0</td></tr> </table>	1: *10.7	←	2: 9.8	→	3: *10.6	↓	4: *10.4	↗	5: *10.5	↓	6: *10.5	←	7: *10.7	↑	8: *10.6	↙	9: *10.5	→	10: *10.7	↗	<hr/>		Serie	99.0	Total	0.0
1: *10.7	←																											
2: 9.8	→																											
3: *10.6	↓																											
4: *10.4	↗																											
5: *10.5	↓																											
6: *10.5	←																											
7: *10.7	↑																											
8: *10.6	↙																											
9: *10.5	→																											
10: *10.7	↗																											
<hr/>																												
Serie	99.0																											
Total	0.0																											
		<table style="width:100%; border-collapse: collapse;"> <tr><td>11: *10.5</td><td style="text-align:right;">→</td></tr> <tr><td>12: *10.5</td><td style="text-align:right;">←</td></tr> <tr><td>13: 9.4</td><td style="text-align:right;">←</td></tr> <tr><td>14: *10.6</td><td style="text-align:right;">↑</td></tr> <tr><td colspan="2"><hr/></td></tr> <tr><td>Serie</td><td style="text-align:right;">39.0</td></tr> <tr><td>Total</td><td style="text-align:right;">0.0</td></tr> </table>	11: *10.5	→	12: *10.5	←	13: 9.4	←	14: *10.6	↑	<hr/>		Serie	39.0	Total	0.0												
11: *10.5	→																											
12: *10.5	←																											
13: 9.4	←																											
14: *10.6	↑																											
<hr/>																												
Serie	39.0																											
Total	0.0																											
		<table style="width:100%; border-collapse: collapse;"> <tr><td>1: *10.7</td><td style="text-align:right;">↑</td></tr> <tr><td>2: 9.8</td><td style="text-align:right;">↑</td></tr> <tr><td>3: 9.7</td><td style="text-align:right;">↙</td></tr> <tr><td>4: 10.1</td><td style="text-align:right;">↗</td></tr> <tr><td>5: *10.6</td><td style="text-align:right;">↓</td></tr> <tr><td>6: *10.3</td><td style="text-align:right;">→</td></tr> <tr><td>7: *10.4</td><td style="text-align:right;">↙</td></tr> <tr><td>8: 9.6</td><td style="text-align:right;">→</td></tr> <tr><td>9: *10.3</td><td style="text-align:right;">↑</td></tr> <tr><td>10: 9.7</td><td style="text-align:right;">↙</td></tr> <tr><td colspan="2"><hr/></td></tr> <tr><td>Serie</td><td style="text-align:right;">96.0</td></tr> <tr><td>Total</td><td style="text-align:right;">96.0</td></tr> </table>	1: *10.7	↑	2: 9.8	↑	3: 9.7	↙	4: 10.1	↗	5: *10.6	↓	6: *10.3	→	7: *10.4	↙	8: 9.6	→	9: *10.3	↑	10: 9.7	↙	<hr/>		Serie	96.0	Total	96.0
1: *10.7	↑																											
2: 9.8	↑																											
3: 9.7	↙																											
4: 10.1	↗																											
5: *10.6	↓																											
6: *10.3	→																											
7: *10.4	↙																											
8: 9.6	→																											
9: *10.3	↑																											
10: 9.7	↙																											
<hr/>																												
Serie	96.0																											
Total	96.0																											
		<table style="width:100%; border-collapse: collapse;"> <tr><td>11: 10.1</td><td style="text-align:right;">↙</td></tr> <tr><td>12: *10.5</td><td style="text-align:right;">↑</td></tr> <tr><td>13: *10.6</td><td style="text-align:right;">↓</td></tr> <tr><td>14: 9.9</td><td style="text-align:right;">→</td></tr> <tr><td>15: *10.3</td><td style="text-align:right;">→</td></tr> <tr><td>16: *10.5</td><td style="text-align:right;">↓</td></tr> <tr><td>17: 9.9</td><td style="text-align:right;">↘</td></tr> <tr><td>18: 10.1</td><td style="text-align:right;">↙</td></tr> <tr><td>19: 9.9</td><td style="text-align:right;">↙</td></tr> <tr><td>20: 9.8</td><td style="text-align:right;">↗</td></tr> <tr><td colspan="2"><hr/></td></tr> <tr><td>Serie</td><td style="text-align:right;">96.0</td></tr> <tr><td>Total</td><td style="text-align:right;">192.0</td></tr> </table>	11: 10.1	↙	12: *10.5	↑	13: *10.6	↓	14: 9.9	→	15: *10.3	→	16: *10.5	↓	17: 9.9	↘	18: 10.1	↙	19: 9.9	↙	20: 9.8	↗	<hr/>		Serie	96.0	Total	192.0
11: 10.1	↙																											
12: *10.5	↑																											
13: *10.6	↓																											
14: 9.9	→																											
15: *10.3	→																											
16: *10.5	↓																											
17: 9.9	↘																											
18: 10.1	↙																											
19: 9.9	↙																											
20: 9.8	↗																											
<hr/>																												
Serie	96.0																											
Total	192.0																											
		<table style="width:100%; border-collapse: collapse;"> <tr><td>21: 9.8</td><td style="text-align:right;">→</td></tr> <tr><td>22: *10.5</td><td style="text-align:right;">↗</td></tr> <tr><td>23: 9.9</td><td style="text-align:right;">↘</td></tr> <tr><td>24: 9.8</td><td style="text-align:right;">←</td></tr> <tr><td>25: 10.1</td><td style="text-align:right;">←</td></tr> <tr><td>26: *10.4</td><td style="text-align:right;">↙</td></tr> <tr><td>27: *10.2</td><td style="text-align:right;">↗</td></tr> <tr><td>28: *10.6</td><td style="text-align:right;">↗</td></tr> <tr><td>29: *10.4</td><td style="text-align:right;">↙</td></tr> <tr><td>30: 10.1</td><td style="text-align:right;">↘</td></tr> <tr><td colspan="2"><hr/></td></tr> <tr><td>Serie</td><td style="text-align:right;">97.0</td></tr> <tr><td>Total</td><td style="text-align:right;">289.0</td></tr> </table>	21: 9.8	→	22: *10.5	↗	23: 9.9	↘	24: 9.8	←	25: 10.1	←	26: *10.4	↙	27: *10.2	↗	28: *10.6	↗	29: *10.4	↙	30: 10.1	↘	<hr/>		Serie	97.0	Total	289.0
21: 9.8	→																											
22: *10.5	↗																											
23: 9.9	↘																											
24: 9.8	←																											
25: 10.1	←																											
26: *10.4	↙																											
27: *10.2	↗																											
28: *10.6	↗																											
29: *10.4	↙																											
30: 10.1	↘																											
<hr/>																												
Serie	97.0																											
Total	289.0																											
		<table style="width:100%; border-collapse: collapse;"> <tr><td>31: *10.5</td><td style="text-align:right;">←</td></tr> <tr><td>32: *10.5</td><td style="text-align:right;">→</td></tr> <tr><td>33: *10.7</td><td style="text-align:right;">↘</td></tr> <tr><td>34: 9.9</td><td style="text-align:right;">↗</td></tr> <tr><td>35: *10.7</td><td style="text-align:right;">↓</td></tr> <tr><td>36: 9.7</td><td style="text-align:right;">↓</td></tr> <tr><td>37: *10.6</td><td style="text-align:right;">↑</td></tr> <tr><td>38: *10.6</td><td style="text-align:right;">↑</td></tr> <tr><td>39: *10.5</td><td style="text-align:right;">↗</td></tr> <tr><td>40: *10.7</td><td style="text-align:right;">←</td></tr> <tr><td colspan="2"><hr/></td></tr> <tr><td>Serie</td><td style="text-align:right;">98.0</td></tr> <tr><td>Total</td><td style="text-align:right;">387.0</td></tr> </table>	31: *10.5	←	32: *10.5	→	33: *10.7	↘	34: 9.9	↗	35: *10.7	↓	36: 9.7	↓	37: *10.6	↑	38: *10.6	↑	39: *10.5	↗	40: *10.7	←	<hr/>		Serie	98.0	Total	387.0
31: *10.5	←																											
32: *10.5	→																											
33: *10.7	↘																											
34: 9.9	↗																											
35: *10.7	↓																											
36: 9.7	↓																											
37: *10.6	↑																											
38: *10.6	↑																											
39: *10.5	↗																											
40: *10.7	←																											
<hr/>																												
Serie	98.0																											
Total	387.0																											
		<table style="width:100%; border-collapse: collapse;"> <tr><td>41: *10.3</td><td style="text-align:right;">↗</td></tr> <tr><td>42: *10.3</td><td style="text-align:right;">↘</td></tr> <tr><td>43: *10.4</td><td style="text-align:right;">←</td></tr> <tr><td>44: *10.5</td><td style="text-align:right;">↘</td></tr> <tr><td>45: *10.5</td><td style="text-align:right;">↘</td></tr> <tr><td>46: *10.4</td><td style="text-align:right;">↑</td></tr> <tr><td>47: *10.9</td><td style="text-align:right;">↘</td></tr> <tr><td>48: *10.2</td><td style="text-align:right;">↘</td></tr> <tr><td>49: *10.6</td><td style="text-align:right;">←</td></tr> <tr><td>50: 10.0</td><td style="text-align:right;">↓</td></tr> <tr><td colspan="2"><hr/></td></tr> <tr><td>Serie</td><td style="text-align:right;">100.0</td></tr> <tr><td>Total</td><td style="text-align:right;">487.0</td></tr> </table>	41: *10.3	↗	42: *10.3	↘	43: *10.4	←	44: *10.5	↘	45: *10.5	↘	46: *10.4	↑	47: *10.9	↘	48: *10.2	↘	49: *10.6	←	50: 10.0	↓	<hr/>		Serie	100.0	Total	487.0
41: *10.3	↗																											
42: *10.3	↘																											
43: *10.4	←																											
44: *10.5	↘																											
45: *10.5	↘																											
46: *10.4	↑																											
47: *10.9	↘																											
48: *10.2	↘																											
49: *10.6	←																											
50: 10.0	↓																											
<hr/>																												
Serie	100.0																											
Total	487.0																											
		<table style="width:100%; border-collapse: collapse;"> <tr><td>51: 8.7</td><td style="text-align:right;">←</td></tr> <tr><td>52: *10.6</td><td style="text-align:right;">↓</td></tr> <tr><td>53: *10.9</td><td style="text-align:right;">←</td></tr> <tr><td>54: *10.8</td><td style="text-align:right;">↘</td></tr> <tr><td>55: *10.5</td><td style="text-align:right;">→</td></tr> <tr><td>56: *10.2</td><td style="text-align:right;">↑</td></tr> <tr><td>57: *10.6</td><td style="text-align:right;">↗</td></tr> <tr><td>58: *10.6</td><td style="text-align:right;">←</td></tr> <tr><td>59: *10.5</td><td style="text-align:right;">↘</td></tr> <tr><td>60: 10.1</td><td style="text-align:right;">↗</td></tr> <tr><td colspan="2"><hr/></td></tr> <tr><td>Serie</td><td style="text-align:right;">98.0</td></tr> <tr><td>Total</td><td style="text-align:right;">585.0</td></tr> </table>	51: 8.7	←	52: *10.6	↓	53: *10.9	←	54: *10.8	↘	55: *10.5	→	56: *10.2	↑	57: *10.6	↗	58: *10.6	←	59: *10.5	↘	60: 10.1	↗	<hr/>		Serie	98.0	Total	585.0
51: 8.7	←																											
52: *10.6	↓																											
53: *10.9	←																											
54: *10.8	↘																											
55: *10.5	→																											
56: *10.2	↑																											
57: *10.6	↗																											
58: *10.6	←																											
59: *10.5	↘																											
60: 10.1	↗																											
<hr/>																												
Serie	98.0																											
Total	585.0																											